

TESTING CORD ASSEMBLIES
2-CONDUCTOR CORDS
2W29A THROUGH 2W48A
DESCRIPTION

1. GENERAL

1.01 This section lists and illustrates the 2W29A through 2W48A 2-conductor cords.

1.02 This section is reissued to:

- Update the format
- Rate the 2W34A cord Mfr Disc.

Revision arrows have been used to emphasize the more significant changes. The Equipment Test List is not affected.

1.03 For general information on these cords, refer to Section 032-312-100.

2. DESCRIPTION OF CORDS

2W29A

1 R2CU cord, 6 feet long, equipped as shown.

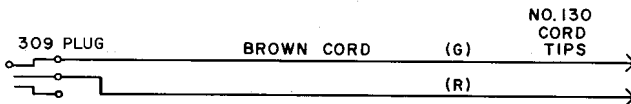

Res 0.16 Ω /ft

2W30A

1 W2BR cord, 4 feet long, equipped as shown.

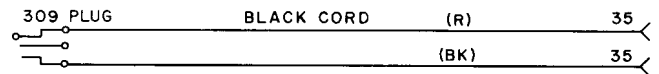

Res 0.006 Ω /ft

2W32A

1 R2DB cord, 6 feet long, equipped as shown.



Res 0.16 Ω /ft

NOTICE

Not for use or disclosure outside the
Bell System except under written agreement

SECTION 032-312-122

2W33A

1 W2BS cord, 5 feet long, equipped as shown.

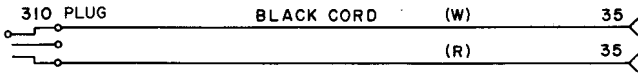

Res 0.21 Ω /ft

2W34A—MFR DISC.

No replacement.

2W35A

1 W2BY cord, 4 feet 6 inches long, equipped as shown.

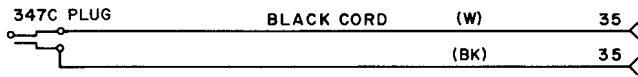

Res 0.006 Ω /ft

2W36A

1 W2GH cord, 5 feet 6 inches long, equipped as shown.

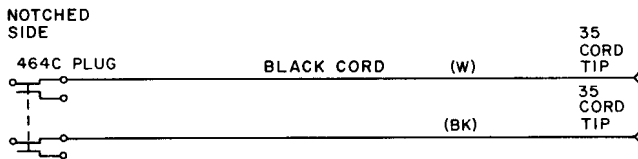

Res 0.004 Ω /ft

2W37A

1 W2DB cord, 4 feet long, equipped as shown.

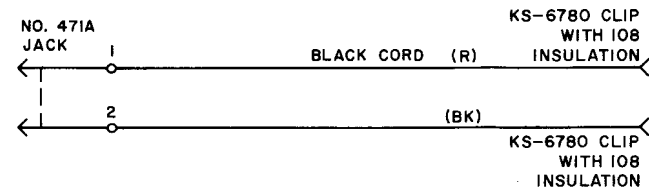

Res 0.16 Ω /ft

2W38A

1 W2CK cord, 5 feet long, equipped as shown.

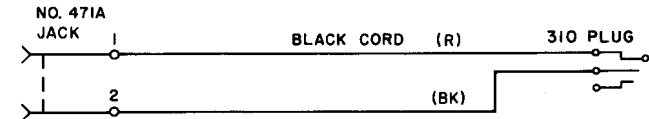

Res 0.21 Ω /ft

2W39A

1 W2CL cord, 4 feet long, equipped as shown.

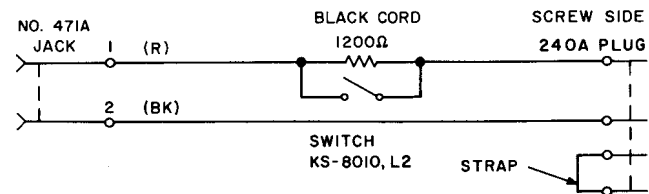

Res 0.21 Ω /ft

2W39B

1 W2CL cord, 4 feet long, equipped as shown.

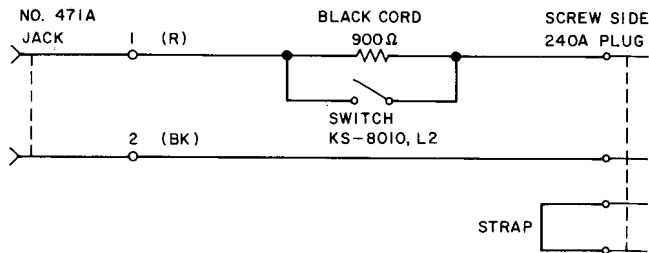

Res 0.21 Ω /ft

The cord was initially intended for use with 1014A handsets to simulate the dialing conditions encountered in long loops.

2W40A

1 W2CL cord, 4 feet long, equipped as shown.

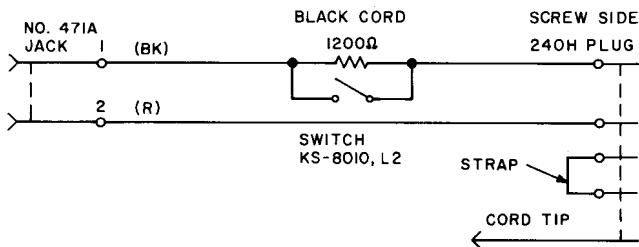

Res 0.21 Ω /ft

2W40B

1 W2CL cord, 4 feet long, equipped as shown.

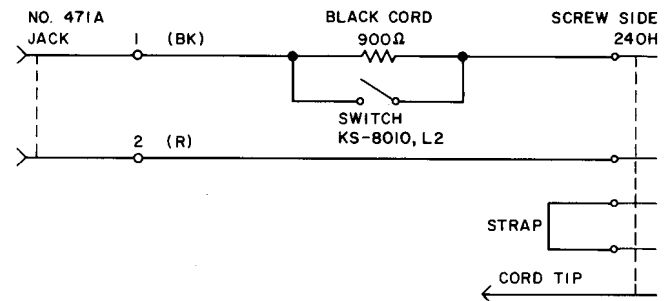

Res 0.21 Ω /ft

The cord was initially intended for use with 1014A handsets to simulate the dialing conditions encountered in long loops.

2W41A

1 W2CJ cord, 4 feet long, equipped as shown.

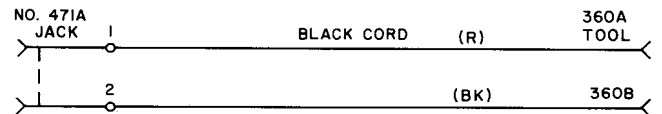

Res 0.16 Ω /ft

SECTION 032-312-122

2W42A (recommended for 2W27A cord)

1 W2DL cord, 5 feet 6 inches long, equipped as shown.

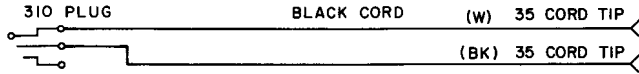

Res 0.006 Ω /ft

2W43A

1 W2EL cord, 8 feet long, equipped as shown.

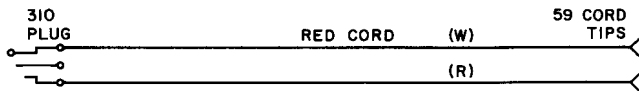

Res 0.02 Ω /ft

2W44A

1 W2EM cord, 3 feet long, equipped as shown.

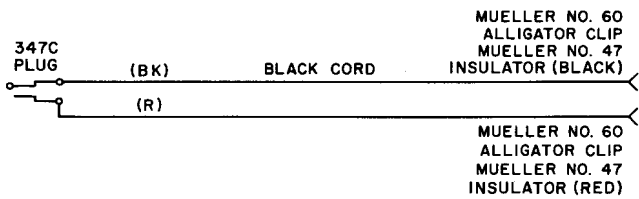

Res 0.01 Ω /ft

The cord was initially intended for use with the J70119B (164C2) telegraph transmission measuring set.

2W45A

1 W2CL cord, 4 feet long, equipped as shown.

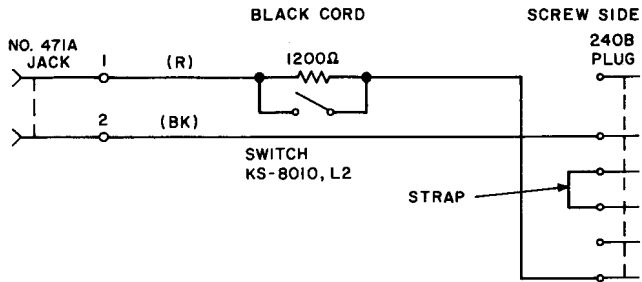

Res 0.21 Ω /ft

The 2W45A cord was initially intended for use with the 1011G handset for testing 200 point connectors in step-by-step systems.

2W46A

1 R2DN cord, 2 feet 6 inches long, equipped as shown.

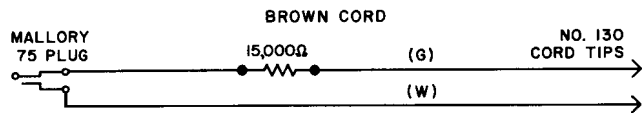

Res 0.16 Ω /ft

The cord was initially intended for use with the J94003A (3A) noise measuring set and the 723A receiver.

2W47A

2W47B

The 2W47A cord includes 1 W2FE cord, 9 feet 6 inches long, equipped as shown.

Res 0.21 Ω /ft

The 2W47B cord includes 1 W2FE cord, 19 feet 6 inches long, equipped as shown.

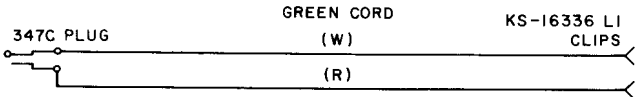

Res 0.21 Ω /ft

2W48A

1 W2FR cord, 5 feet long, equipped as shown.

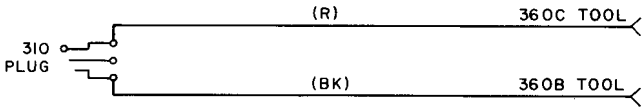

Res 0.01 Ω /ft

The cord was initially intended for use with the 22A milliwatt reference meter (J94022A).