

## CODED JACKS—350 THROUGH 399

### DESCRIPTION

#### 1. GENERAL

1.01 This section lists and illustrates coded jacks within the part or type number range of 350 through 399, used for the maintenance and operation of equipment in central offices.

1.02 The information provided in this section was previously shown in Section 032-511-101, Issue 3. The following is a list of jacks that have been Mfr Disc., with their replacements:

JACKS	REPLACEMENT
391A-49	547B-49
391A-50	547B-50
391A-54	547B-54
392A-49	551A-49
392A-50	551A-50

The Equipment Test List is not affected.

#### 2. DESCRIPTION OF CODED JACKS

2.01 **350A:** This multicontact jack (Fig. 1) is used with the 240A or similar-type plugs. This jack consists of a metal bracket on which there are mounted two pairs of contact springs insulated from each other. This jack is intended primarily for terminating test or switching talking lines in step-by-step machine switching systems. The 350A jack is intended to be mounted on shelf frame work used for mounting wired assemblies. The terminals are arranged for mechanically wrapped connections.

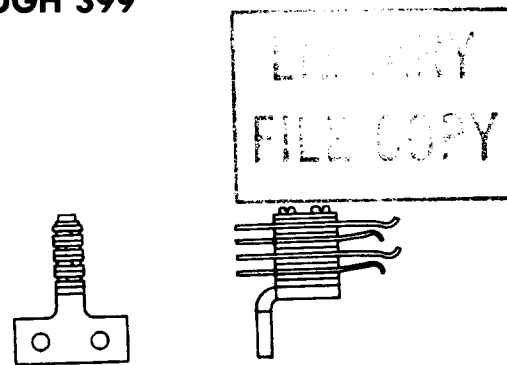

Fig. 1—350A Jack

2.02 **354:** This multicontact jack (Fig. 2) is used with the 240D plug in the test set of the rotary test circuit of Step-By-Step Dial Systems.

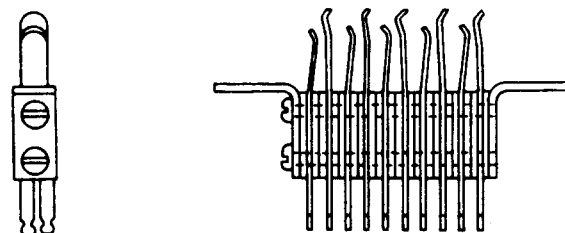

Fig. 2—354A Jack

2.03 **355C:** This single-mounted jack (Fig. 3) is to be mounted with the springs in a vertical plane and is arranged to be used with the 347 or similar-type plugs.

#### NOTICE

Not for use or disclosure outside the  
Bell System except under written agreement

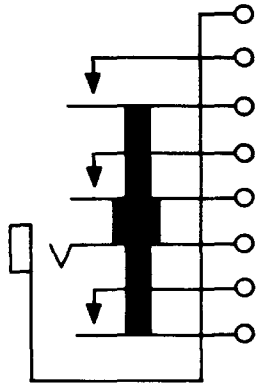

Fig. 3—355C Jack

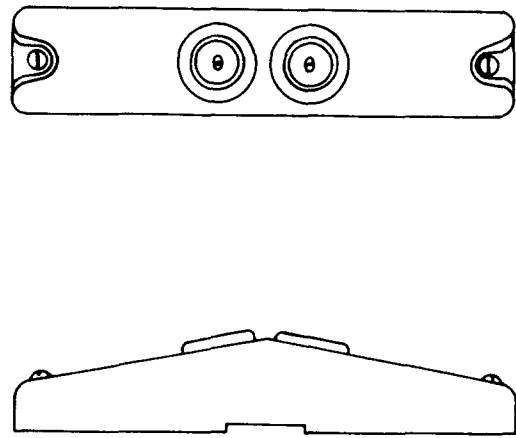

Fig. 5—358A or C Jack

2.04 **357A:** This multicontact jack (Fig. 4) is used with the 240A plugs in connection with a switchman's talking line circuit in Step-By-Step Systems.

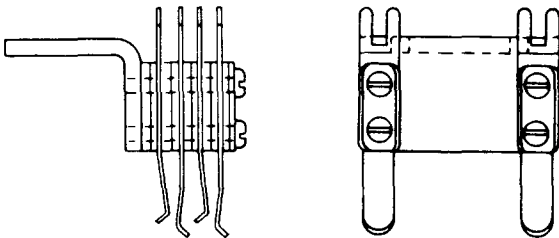

Fig. 4—357A Jack

2.05 **358A and C:** These headset jacks (Fig. 5) are used in straight forward trunking installations to enable the "B" operator to manually connect a headset to the called incoming trunk, in the event that the apparatus, which normally performs this function, should fail or where automatic listening is not economical. These jacks mount on the face of the switchboard across the stile strip, between alternate pairs of "B" operators' positions. These jacks are also furnished with spacers for mounting on 10 and 1D-type switchboards.

2.06 **360A and C:** These single-mounted jacks (Fig. 6) are heavily insulated and intended to be mounted with the springs in a vertical plane. These jacks are used with the 310 plug.

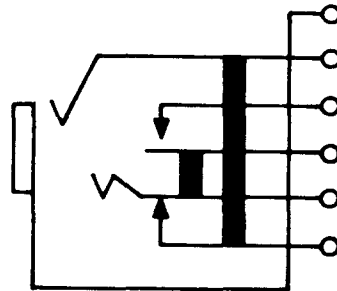

Fig. 6—360A or C Jack

2.07 **361C:** This single-mounted jack (Fig. 7) is heavily insulated and intended to be mounted with the springs in a vertical plane. The 361C jack is used with the 347 plug.

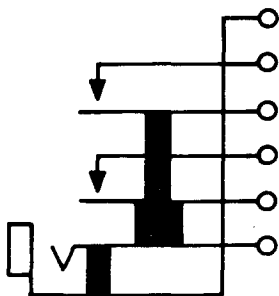

Fig. 7—361C Jack

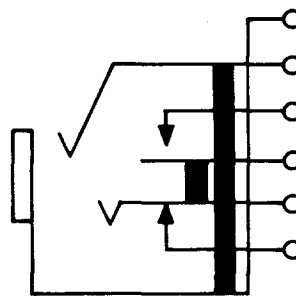

Fig. 9—363-Type Jack

2.08 **362:** This strip-mounted jack (Fig. 8) is used with 310 or similar-type plugs. This jack is also used with the 109, 110, 116, 131, 136, 137, 250A or similar-type jack mountings.

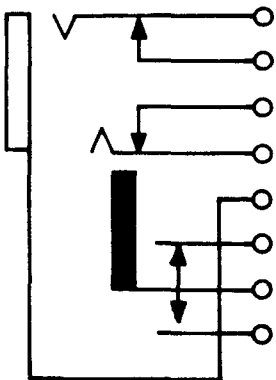

Fig. 8—362 Jack

2.10 **365:** This strip-mounted jack (Fig. 10) is furnished only on orders for jack mountings and is used with the 310 plug. The 365 jack is used with 107, 108, 109, 110, 112, 115, 116, 131, 136, 137, 180, 181, 217A, and 250A jack mountings.

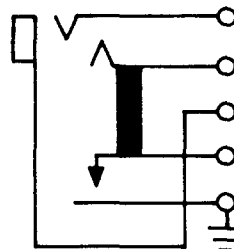

Fig. 10—365 Jack

2.09 **363A, C, and CM:** These single-mounted jacks (Fig. 9) are used with the 310 or similar-type plugs. These jacks are heavily insulated and are specially designed and adjusted for use in telegraph repeater equipments for limited service only. The 363-type jacks are recommended for general use. These jacks are intended to be mounted with the springs in a vertical plane. The 363CM jack is equipped with mechanically wrapped connections.

2.11 **366:** This single-mounted jack (Fig. 11) is used with the 240A plug.



Fig. 11—366 Jack

**2.12 372A and C:** These are single-mounted jacks (Fig. 12). These jacks are used with the 757A PBX common control switching and with the 310 or 184-type plugs.

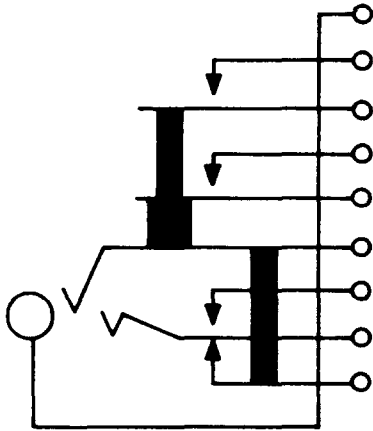

Fig. 12—372A or C Jack

- (a) **372A:** This jack is intended to be mounted with the springs in a vertical plane.
- (b) **372C:** This jack is used with the 757A PBX common control switching. This jack is intended to mount in the 252A and similar jack mountings inasmuch as the height of the spring pileup will not permit mounting by means of a screw inserted from the rear of the mounting lug.

**2.13 384A, B, and C:** These multicontact jacks (Fig. 13) each consist of a metal bracket, pileups of six contact springs, and number plate holders. Each spring pileup is arranged for a 240B plug. The terminals are arranged for mechanically wrapped connections. These jacks are intended for use on 161-type, 931A, 961D, 986-type, and similar mounting plates in dial systems.

- (a) **384A:** The 384A jack has one spring pileup and one plate holder
- (b) **384B:** The 384B jack has two spring pileups and one plate holder
- (c) **384C:** The 384C jack has two spring pileups and two plate holders.

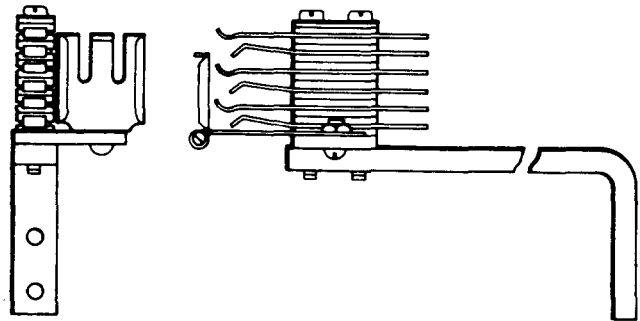

Fig. 13—384-Type Jack

**2.14 387A, C, and D:** These single mounted jacks (Fig. 14) are used with the 310 or similar-type plugs. These jacks are heavily insulated and are intended to be mounted with the springs in a vertical plane.

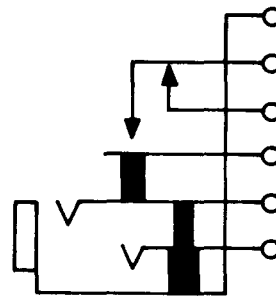

Fig. 14—387-Type Jack

**2.15 394C:** This single-mounted jack (Fig. 15) is used with the 347 or similar-type plugs. This jack is intended to be mounted with the springs in a vertical plane.

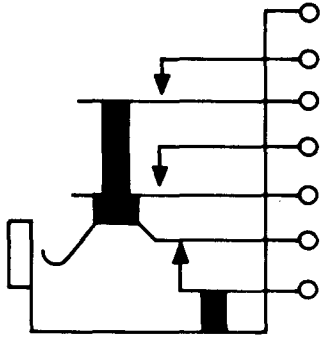

Fig. 15—394C Jack

**2.16 395A:** This multicontact jack (Fig. 16) is arranged for a 240B plug. The jack is used with the SD-31428-01 outgoing repeater circuit in Step-By-Step Telephone Systems. This jack consists of two metal brackets between which are mounted three pairs of contact springs insulated from each other. The terminals are arranged for mechanically wrapped connections.

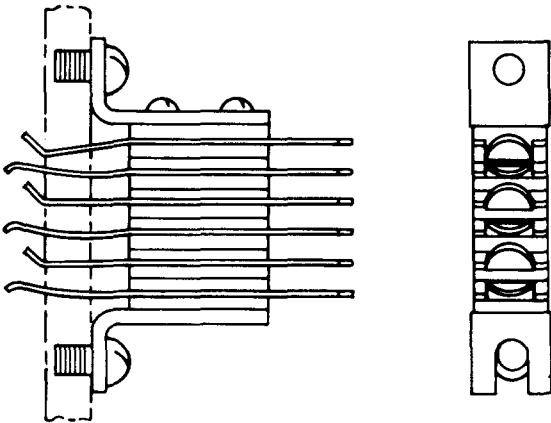

Fig. 16—395A Jack

**2.17 395B:** This multicontact jack (Fig. 17) is arranged for a 240B plug. The jack is used with the SD-31428-01 outgoing repeater circuit in Step-By-Step Telephone Systems. This jack consists of two metal brackets between which are mounted three pairs of contact springs insulated from each other. The terminals are arranged for mechanically wrapped connections.

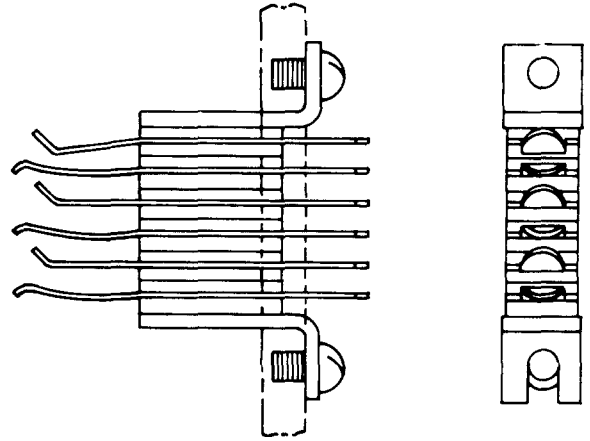

Fig. 17—395B Jack

**2.18 399:** This single-conductor jack (Fig. 18) is used with the 278A plug and is used on the No. 5 toll testboard. This jack is provided with a metallic guard to reduce current leakage between the current carrying member and the mounting surface. The exposed portion of the jack is provided with a removable dust cap.

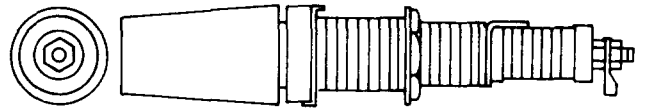

Fig. 18—399 Jack