

P1 CARRIER TELEPHONE SYSTEM INSTALLATION AND CONNECTIONS REPEATERS

1. GENERAL

1.01 The procedure for the installation of repeaters differs, depending upon the type of power supply used.

1.02 This section is reissued to include information on J98707M power supply and to provide alternate installation procedures appropriate to the power supply being installed.

1.03 The general procedure for the installation of a repeater is as follows:

- For the J86463A or B power supply:

- (1) Verify that the power and repeater housings are mounted securely and are grounded properly. If power over the cable is used, no pole-mounted power supply will be furnished. In this event, omit Steps 2 and 3 below.
- (2) Install and adjust the power supply.
- (3) Connect the power supply to the repeater housing.
- (4) Mount the 803B connector in the 386A apparatus case.
- (5) Verify the position of boards.
- (6) Connect local cable to line board.
- (7) If power over the cable is used, connect the carrier line toward the source of power. Verify that the local cable used is J98707E, List 3 (LC-800-179).
- (8) Continue per section entitled P1 Carrier Telephone System, Adjustments and Maintenance, Repeaters, General Information and Test Equipment.

- For the J98707M, List 2 power supply:

- (1) Verify that the combined power and repeater housing is mounted securely and is grounded properly.
- (2) Install and verify the operation of the power supply.
- (3) Mount the 803B connector in the 386C apparatus case.

Note: At coterminous installations the second, third, and fourth 803B connector will be installed in a 386A apparatus case.

- (4) For coterminous locations, connect the dc power from the 386C apparatus case terminal block to the 386A apparatus case terminal blocks. (See Fig. 2.)
- (5) Verify the position of boards.
- (6) Connect local cable to line board.
- (7) Continue per section entitled P1 Carrier Telephone System, Adjustments and Maintenance, Repeaters, General Information and Test Equipment.

2. INSTALLATION

2.01 Before proceeding with the installation, verify that the 386A or 386C apparatus case is bonded and grounded properly and that the power company and telephone company ground rods are bonded together as covered in the Plant Series sections under P1 carrier telephone system. If power over the cable is used, omit the above grounding and connect a No. 10 wire from the cable sheath to the lower GRD lug on the 386A apparatus case. Refer to Chart A.

2.02 Install and adjust the power supply per section entitled Station Systems—P1 Carrier, Power Plant—J86463A; Station Systems—P1 Carrier, Power Plant—J86463B; or Station Systems—P1 Carrier, Power Plant—J98707M.

2.03 For the J86463A or B, connect the power supply to the terminal block on the 386A apparatus case. See Chart A for wiring details.

2.04 For the J98707M, List 2, power connections are made at the factory. At coterminous installations connect dc power to the terminal housings that do not contain the power supply. See Chart A for wiring details.

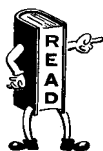

Before making any external connections to the power supply remove all discharge fuses in order to avoid internal damage to the bias voltage circuit. After wiring is completed, replace fuses.

2.05 Position the 803B connector on top of the line connector storage shelf. Be sure the stud on the storage shelf is seated in the hole on the bottom of the connector. Fasten the top of the connector to the rear of the 386A or 386C apparatus case by the two captive screws located in the right and left top corners of the 803B connector.

2.06 Factory-tested repeaters are shipped with the network boards in proper position. To verify positions or to assemble repeaters from reused equipment, refer to Chart B.

Note: Do not install pads at this time. Installation of pads is covered in section entitled P1 Carrier Telephone System, Adjustments and Maintenance, Repeaters, Preparation for Connecting to Line.

Connections

2.07 Connect the local cable to the line board. The cable assembly is factory terminated on the underside of the terminal block on the 386A or 386C apparatus case and is fastened to the case with a Tinnerman cord clamp. This local cable is preformed and ready to connect to the line board. Charts C, D, and E show the connections to be made on the 800AA and 800AU network line board using the lists 1, 2, and 3 local cables. If the

800AA line board is used, verify that this line board has been modified per section entitled P1 Carrier Telephone System, Adjustments and Maintenance, Repeaters, Field Modification of 800AA Network Line Board and 386A Apparatus Case. The local cable and 800 network line board combination shown in Chart F must be strictly adhered to.

2.08 If power over the cable is used, proceed as follows:

(1) Pull the line pair toward the source of power through the grommet as shown in Chart A.

(2) Prepare the line pair for connection.

(3) Verify positive (ring) side of carrier pair. Using KS-14510 volt-ohm-milliammeter (300-volt scale), place negative test lead on binding post 22 of the 386A terminal block. Connect positive test lead of meter to each line conductor in turn. Ring side of line should measure 130 volts. Connect ring side to binding post 8 or 10, and tip to binding post 7 or 9. See Chart A.

2.09 Connections of the 482G, 482H, and 562A networks used with repeater installations are shown in Fig. 1.

2.10 Wiring for coterminous repeater installation using J98707M, List 2 power supply is shown in Fig. 2.

Adjustments

2.11 Make tests and adjustments covered in section entitled P1 Carrier Telephone System, Adjustments and Maintenance, Repeaters, General Information and Test Equipment.

2.12 If system line-up (per section entitled P1 Carrier Telephone System, Line-Up and Maintenance, General Information and Test Equipment) is not to be performed at this time, seal the repeater as follows:

- (1) Close and fasten the cover of the 803B connector.
- (2) Place a fresh bag of C dessicant per specification AT-7194 at the bottom of the 386A or C apparatus case under the line connector storage shelf.

Note: The C dessicant must be replaced with a fresh bag every time the terminal is opened.

- (3) Close and fasten the 386A or 386C apparatus case cover and terminal block cover with the special Allen wrench.

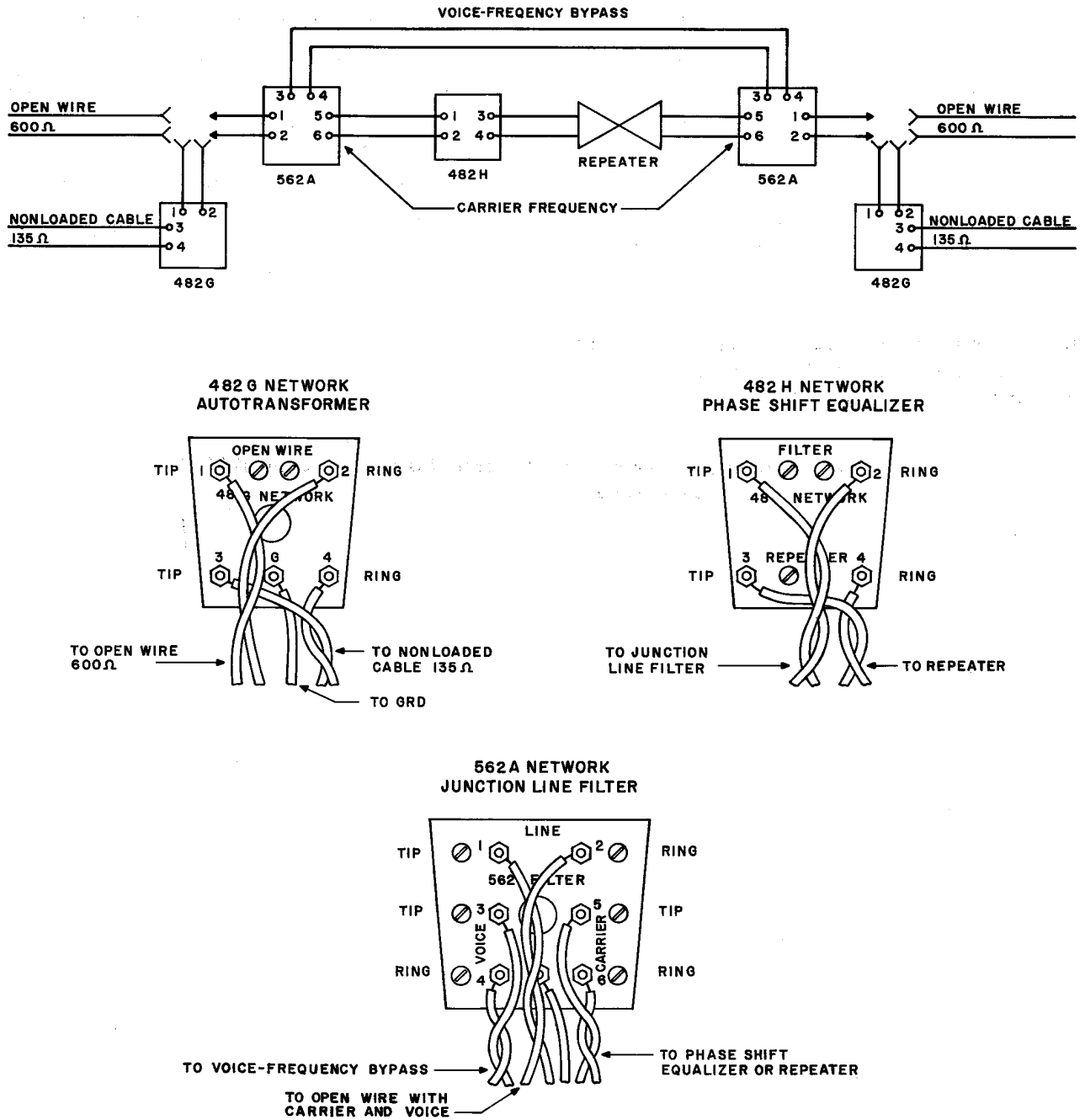
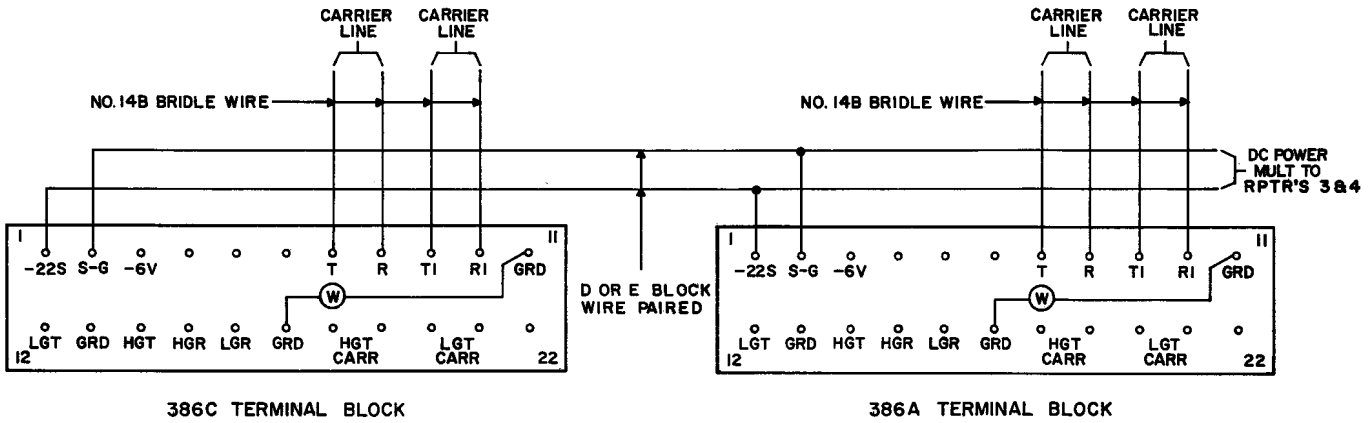
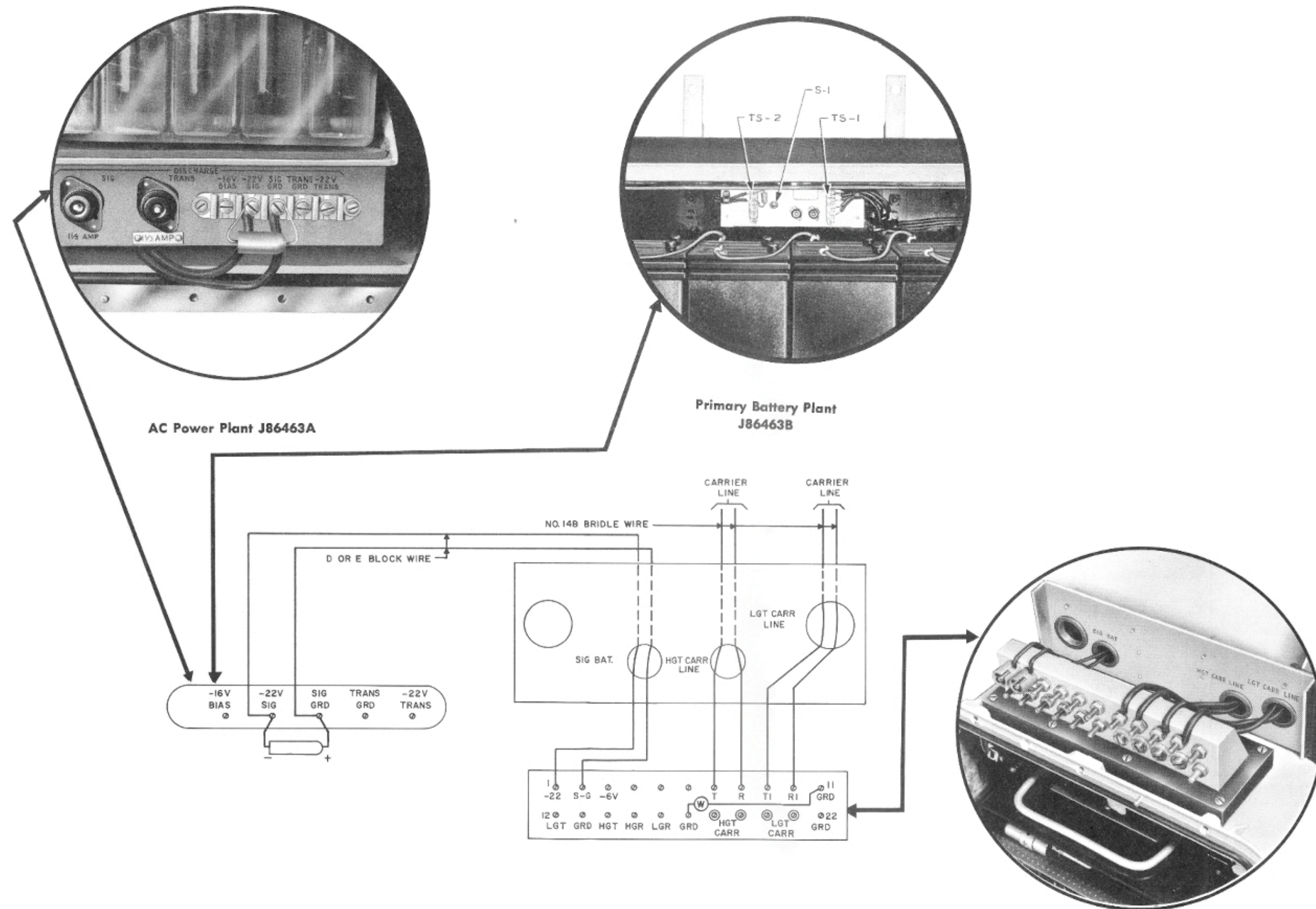

Fig. 1 – Network Application



Note: For single repeater installation the only external wiring required is connections to carrier line.

Fig. 2 — Wiring for Coterminous Repeater Installation Using J98707M, List 2 Power Supply



External Wiring and Line Connections

386A Apparatus Case Repeater

CHART A
REPEATER WIRING CHART - EXTERNAL CONNECTIONS

From	Lead Description	Lead Designation	Binding Post No. on Terminal Block of 386A or 386C Apparatus Case (HGT from CO, preferred direction)	Type and Size of Wire	
Wiring Chart for Terminal Block on 386A or 386C Apparatus Case					
Carrier Line Toward CO	Carrier Line	Tip-Ring	9 T1 (-)* 10 R1 (+)*	No. 14B Bridle	
Carrier Line Toward Rem Term.	Carrier Line	Tip-Ring	7 T (-)* 8 R (+)*	No. 14B Bridle	
DC Power Wiring Using 386A Apparatus Case (Applicable whenever Using J86463A, B, or Power over Cable)					
J86463A and J86463B	Signaling Bat.	-22V SIG	1 -22	"D" or "E" Block Wire Paired	
	Signaling Grd	SIG GRD	2 S-G		
Power over Cable	Cable Sheath Ground	Cable Sheath Ground	Grd Lug on 386A Apparatus Case	No. 10 Ground Wire	
DC Power Wiring Using 386C and 386A Apparatus Case (Applicable to Coterminous Installations Using J98707, List 2)					
J98707M, List 2 (See Note)	Transmission Battery	-22 TRNS	From 386C Term. Blk	1 -22 1st Rptr	"D" or "E" Block Wire Paired
			To 386A Term. Blk	1 -22 Succeeding Rptrs	
	Transmission Ground	GRD TRNS	From 386C Term. Blk	2 S-G 1st Rptr	
			To 386A Term. Blk	2 S-G Succeeding Rptrs	

Note: DC power wiring for 386C is shop wired.
* Observe polarity for power feed over the cable only.

CHART B
NETWORK BOARD SELECTION FOR REPEATER

Position In 803B Connector	Grouped Normal System			Grouped Staggered System		
	High Group from Central Office			High Group from Central Office		
	Nonregulated	Regulated		Nonregulated	Regulated	
	All Repeaters	1st Repeater From Remote Terminal	All Other Repeaters	All Repeaters	1st Repeater From Remote Terminal	All Other Repeaters
ED-97018-30, Group Notes 1 and 2	R(), A(), E() F1, H1, K1	R(), A(), E() F1, H2, K5	R(), A(), E() F1, H2, K3	R(), A(), E() F2, H1, K1	R(), A(), E() F2, H2, K6	R(), A(), E() F2, H2, K4
A See Note 1						
B	800AB	800AB	800AB	800 AB	800AB	800AB
C See Note 5	800AF	800AH	800AH	800AF	800AH	800AH
D	800Y	800Y	800Y	800Y	800Y	800Y
E See Note 3	800AU	800AU	800AU	800AU	800AU	800AU
F See Note 4	800AC	800AC	800AC	800AD	800AD	800AD
G	800Y	800Y	800Y	800Y	800Y	800Y
H See Note 5	800AF	800AM	800AK	800AF	800AL	800AJ
J	800AB	800AB	800AB	800AB	800AB	800AB

Note 1: If ED-97018-30, Group R1 is specified (power over cable), an 800BB network will be furnished for position A. If group R2 is specified, a local power supply will be furnished and no board will be required for position A.

Note 2: Groups A() and E() cover the 337-type equalizer furnished for the amplifier as follows:

Equalizer	High Group Amplifier Position B	Low Group Amplifier Position J
337A	A1	E1
337B	A2	E2
337C	A3	E3
None	A4	E4

Note 3: The 800AA network may be used in nonregulated repeaters not having power furnished over the cable.

Note 4: The 800AC phase equalizer may be replaced upon instructions by the engineer or as the result of line-up tests, by the 800AD dummy phase equalizer. For 3- or 4-repeater systems, an F-53142 equalizer must be placed in position F of the third repeater. Staggered systems use only the 800AD dummy phase equalizer.

Note 5: A dummy regulator, 800AF network, may be specified by the engineer for some of the repeaters in a regulated system. ED-97018-30, Group H1 supplies a dummy regulator for the high group, and group K1 supplies a dummy regulator for the low group.

CHART C
REPEATER WIRING CHART - INTERNAL CONNECTIONS

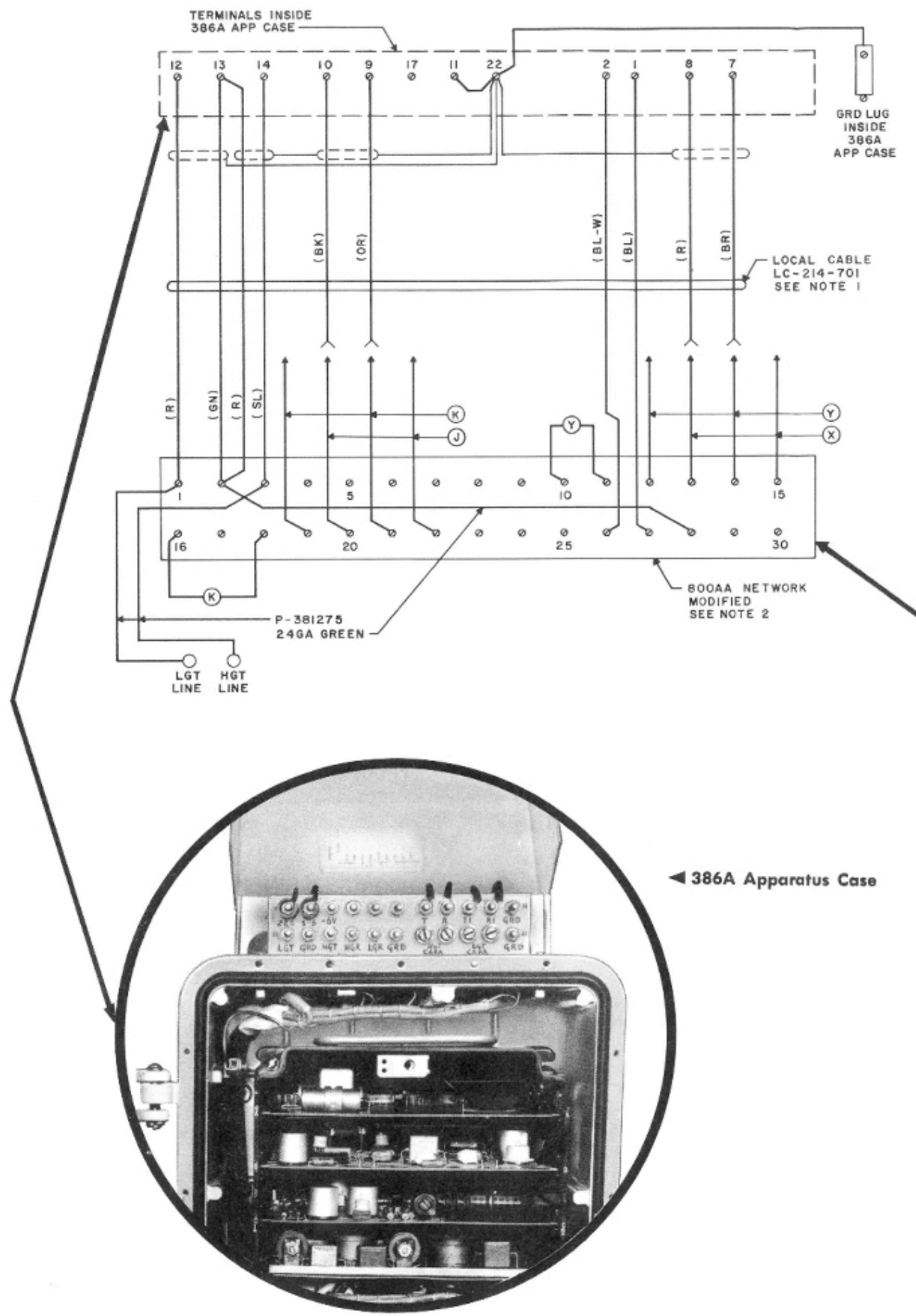

List 1
Local Cable 800AA
Modified Repeater
Connections

Option	Remarks	
X	High Group Transmitting Side of Repeater	600-ohm Line
Y		135-ohm Line
J	Low Group Transmitting Side of Repeater	600-ohm Line
K		135-ohm Line

Note 1: Local cable J98707E, List 1 (LC-214-701) cannot be used for power over cable or regulated repeater.
Note 2: 800AA network cannot be used for power over cable or regulated repeater.

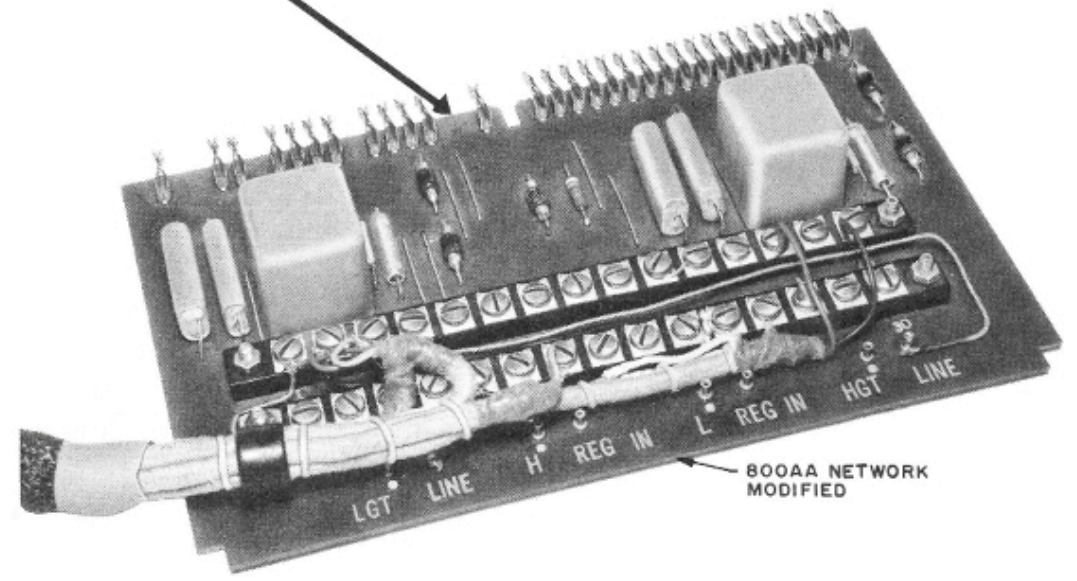

Wiring Chart for 800AA Network (Modified)*

From	Lead Description	Lead Designation	From Terminal Block on 386A App Case	Local Cable Assembly Color Code	Option	Terminal Strip No. On Modified 800AA Network
Carrier Line	Low Group Transmitting Carrier Line	T	9	BK	J	22
		R	10	O	J	21 (Strap 16 and 18.)
		Shield	22	—	K	20 19 Leave unterminated.
Carrier Line	High Group Transmitting Carrier Line	T	7	BR	X	15
		R	8	R	Y	14 (Strap 10 and 11.)
		Shield	22	—	X Y	13 12 Leave unterminated.
Local Power Plant	Battery	-22V SIG	1	BL	—	27
	Ground	GRD	2	BL-W	—	26
External Test Points	LGT Line Test Point	LGT Line	12	R	—	1
	Ground	GRD	13	G	—	2
	Ground	GRD	22	Shield Braid	—	Leave unterminated.
	HGT Line Test Point	HGT Line	14	S	—	3
	Ground	GRD	13	R	—	2
	Ground	GRD	22	Shield Braid	—	Leave unterminated.

* Refer to section entitled P1 Carrier Telephone System, Adjustments and Maintenance, Repeaters, Field Modification of 800AA Network Line Board and 386A Apparatus Case for modification instructions of 800AA network line board.

CHART D
REPEATER WIRING CHART - INTERNAL CONNECTIONS
J98707E, LIST 2 LOCAL CABLE

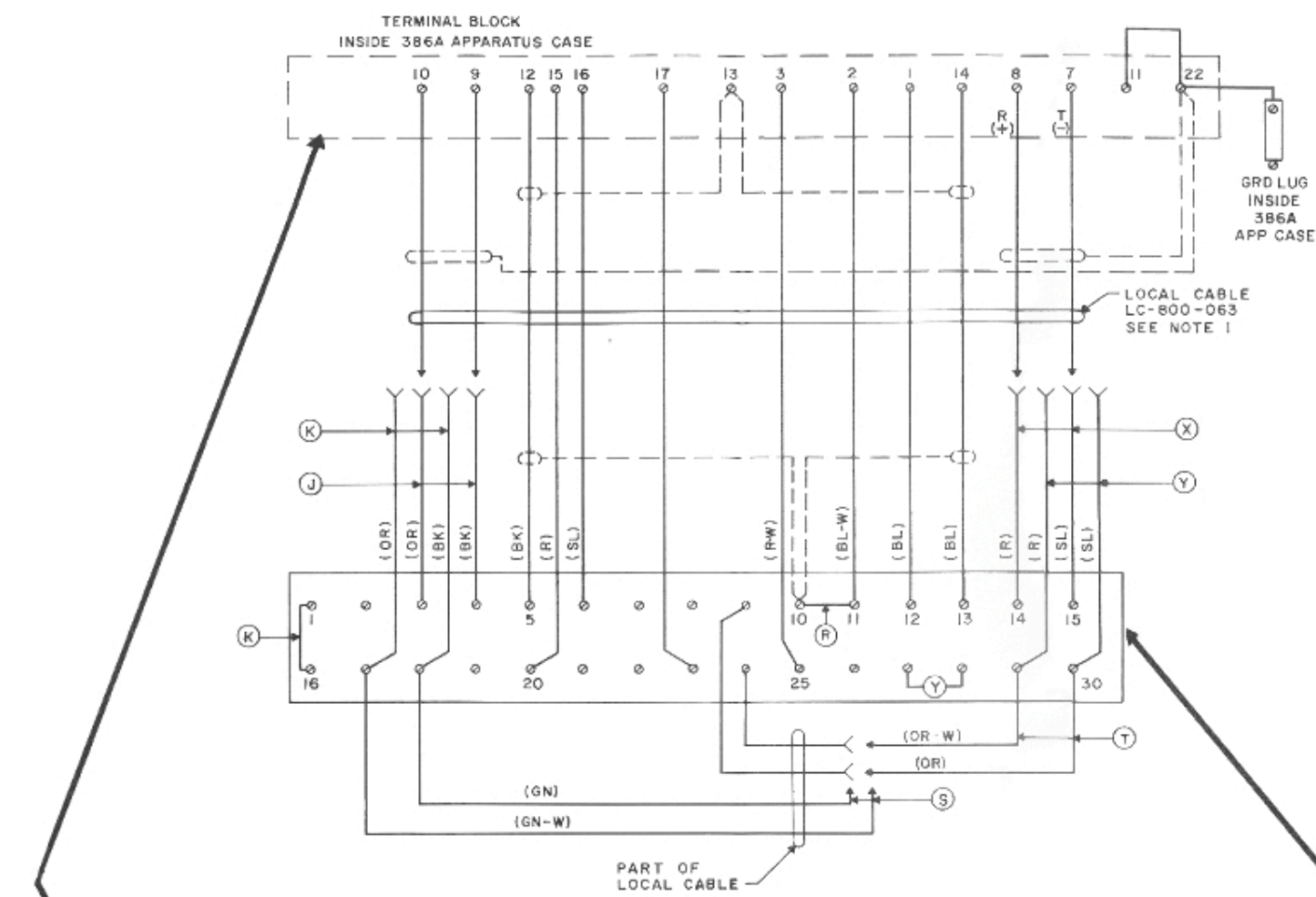

List 2
Local Cable
Repeater Connections

Option	Remarks
X	High Group Transmitting Side of Repeater 600-ohm Line
Y	135-ohm Line
J	Low Group Transmitting Side of Repeater 600-ohm Line
K	135-ohm Line
R	To connect transmission ground to power ground
S	When receiving power over the cable on low group transmitting
T	When receiving power over the cable on high group transmitting

Note 1: Local cable J98707E, List 2 (LC-800-063) cannot be used for power over cable.

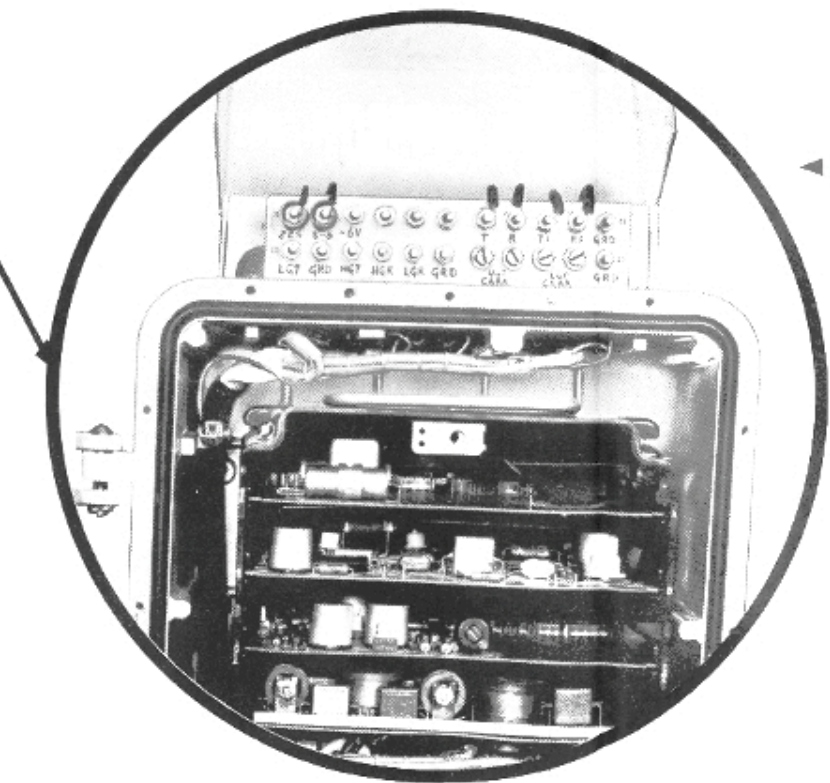

386A Apparatus Case

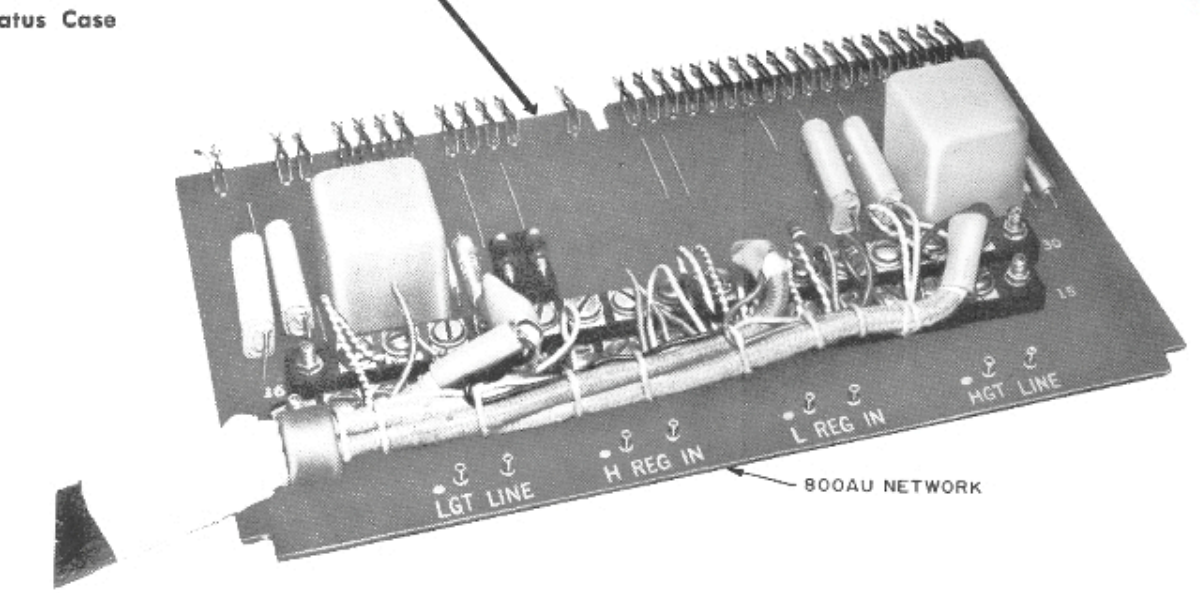

800AU NETWORK

Wiring Chart for 800AU Network*						
From	Lead Description	Lead Designation	From Terminal Block on 386A App Case	Local Cable Assembly Color Code	Option	Terminal Strip No. On 800AU Network
Carrier Line	Low Group Transmitting Carrier Line	T(-)	9	BK	J	4
		R(+)	10	O	K	18 (Strap 1 and 16.)
					J	3
	Shield	22	—			Leave unterminated.
Carrier Line	High Group Transmitting Carrier Line	T(-)	7	S	Y	30 (Strap 27 and 28.)
		R(+)	8	R	X	15
					Y	29
	Shield	22	—			Leave unterminated.
Local Power Plant	Battery	-22V SIG	1	BL		12
	Ground	SIG GRD	2	BL-W		11
	Bias	-6V	3	R-W		25
External Test Points	LGT Line Test Point	LGT	12	O		5
	Shield Braid	Shield	13	Shield Braid		10
	HGT Line Test Point	HGT	14	BL		13
	Shield Braid	Shield	13	Shield Braid		10
	HGR REG Line Test Point	HGR REG	15	R		20
	LGR REG Line Test Point	LGR REG	16	S		6
Internal Strap	Power ground connects to transmission ground.		—	—	R	Strap 10 and 11.

* 800AU network with J98707E, List 2 (LC-800-063) local cable cannot be used for power over the cable.

List 3
Local Cable
Repeater Connections

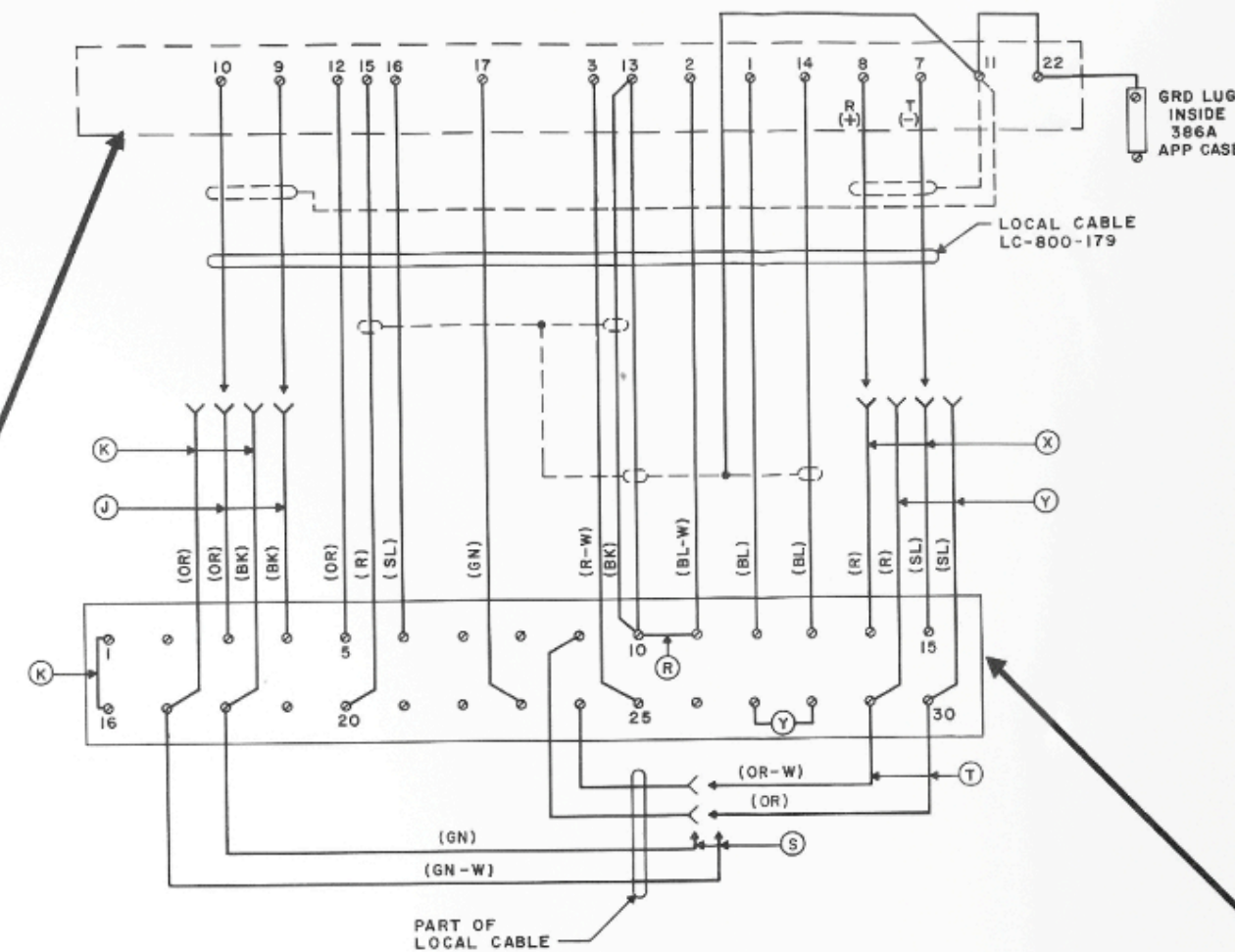

Option	Remarks
X	High Group Transmitting Side of Repeater
Y	Low Group Transmitting Side of Repeater
J	600-ohm Line
K	135-ohm Line
R	To connect transmission ground to power ground
S	When receiving power over the cable on low group transmitting
T	When receiving power over the cable on high group transmitting

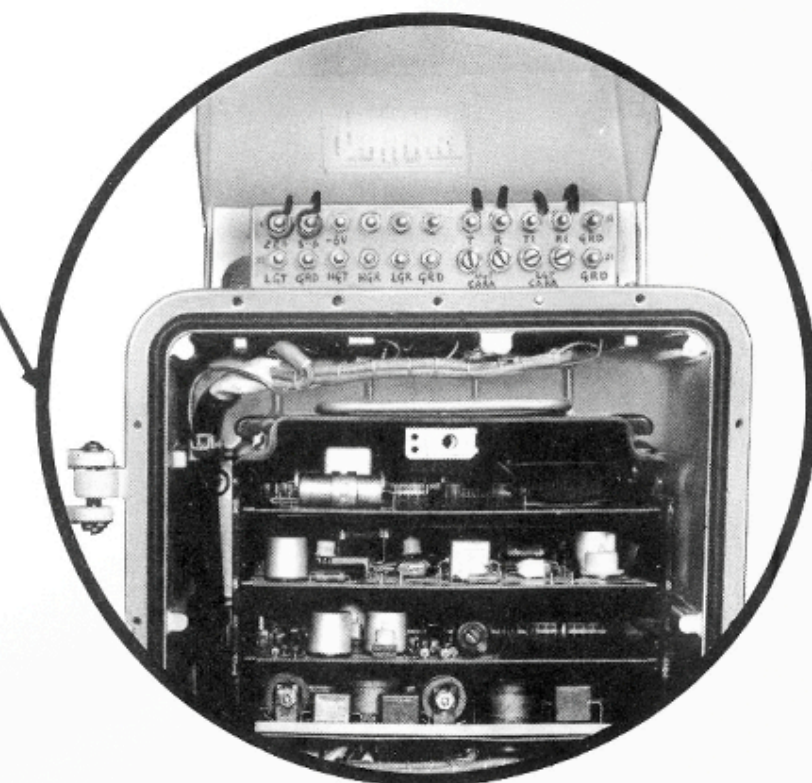

← 386A Apparatus Case

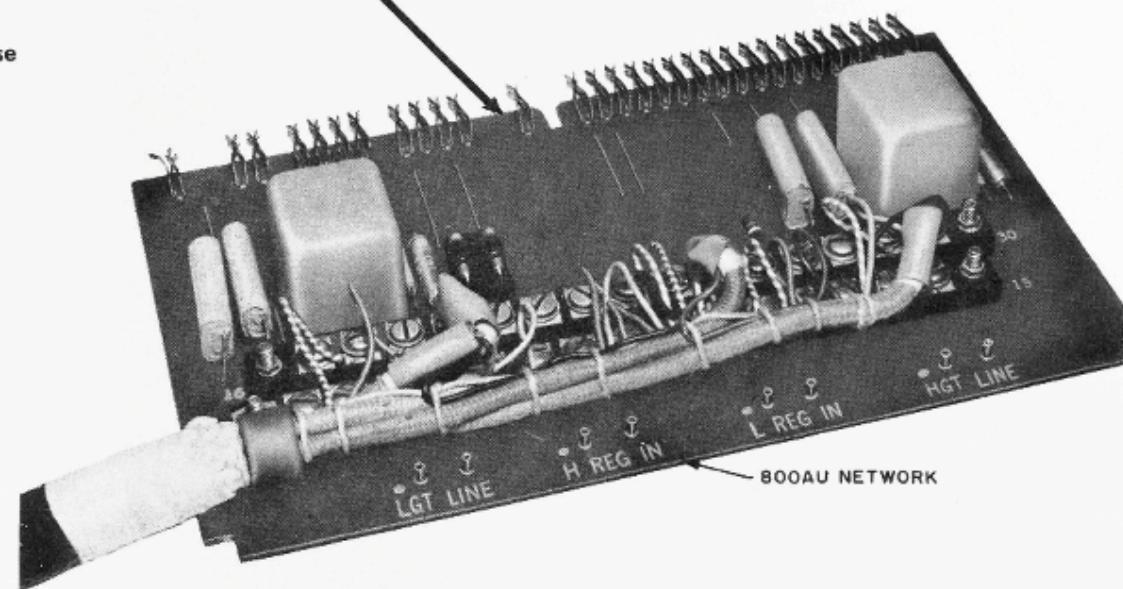

800AU NETWORK

CHART E
REPEATER WIRING CHART — INTERNAL CONNECTIONS
J98707E, LIST 3 LOCAL CABLE

Wiring Chart for 800AU Network						
From	Lead Description	Lead Designation	From Terminal Block on 386A App Case	Local Cable Assembly Color Code	Option	Terminal Strip No. On 800AU Network
Carrier Line	Low Group Transmitting Carrier Line	T(-)	9	BK	J	4
		R(+)	10	O	K	18
		Shield	11	—	—	3
Carrier Line	High Group Transmitting Carrier Line	T(-)	7	S	J	17 (Strap 1 and 16.)
		R(+)	8	R	K	15
		Shield	11	—	—	30
Local Power Plant	Battery	-22V SIG	1	BL	—	14
	Ground	GRD	2	BL-W	—	29 (Strap 28 and 27.)
	Bias	-6V	3	R-W	—	25
External Test Points	LGT Line Test Point	LGT	12	O	—	Leave unterminated.
	Ground	GRD	13	BK	—	5
	Shield	Shield	11	Shield Braid	—	10
	Ground	GRD	13	W	—	10
	HGT Line Test Point	HGT	14	BL	—	13
	Shield	Shield	11	Shield Braid	—	Leave open.
Power Over Cable	HGR REG Test Point	HGR REG	15	R	—	20
	LGR REG Test Point	LGR REG	16	S	—	6
	Power over Cable	—	17	G	—	23
Internal Strap	Power over Cable — LGR XMTG	—	—	—	S	Strap 17 and 24 18 and 9.
	Power over Cable — HGR XMTG	—	—	—	T	Strap 30 and 9 29 and 24.
Internal Strap	Power ground connects to transmission ground.	—	—	—	R	Strap 10 and 11.

CHART F
LOCAL CABLE SELECTION FOR REPEATER

Local Cable	Means of Identification See Terminal Strip Inside 386A Apparatus Case	Used with		800-Type Network Line Board
		Regulated Repeater	Power over Cable	
J98707E, List 1 (LC-214-017)	R and G wire on BP 13	No	No	800AA modified
J98707E, List 2 (LC-800-063)	Two shields on BP 13	Yes	No	800AU
J98707E, List 3 (LC-800-179)	BK and W wires on BP 13	Yes	Yes	800AU