

HANDLING WIRE AND CABLE

1. GENERAL

1.01 This section covers the general factors to be considered when handling wire and cable.

1.02 This section is reissued to show additional information. Since this reissue covers a general revision, arrows ordinarily used to indicate changes have been omitted.

2. REMOVING WIRE OR CABLE FROM A COIL

2.01 To dispense jacketed wire from the carton:

- (1) Punch out perforated hole from carton.
- (2) Place carton on floor and feed wire from center of coil (Fig. 1).

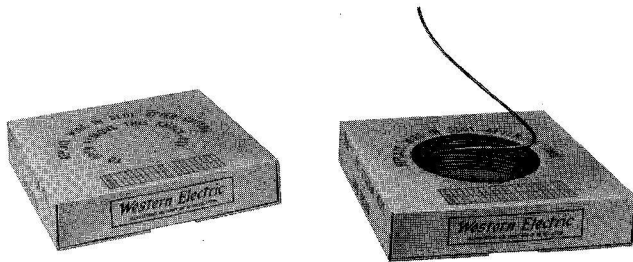

Fig. 1 — Dispensing Jacketed Wire

2.02 To dispense twisted wire from a coil:

- (1) Place coil flat on floor so that inner end will feed from coil in a counterclockwise direction.
- (2) Feed from center of coil (Fig. 2).

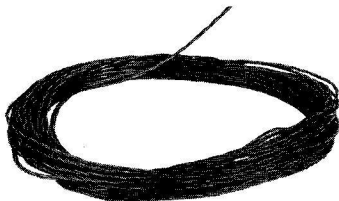

Fig. 2 — Dispensing Twisted Wire

2.03 To pay out cable, remove cable from coil by paying it off from outside of coil (Fig. 3).

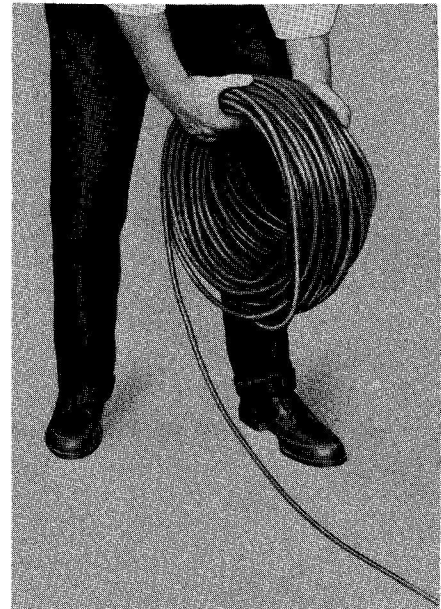
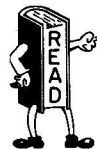

Fig. 3 — Paying Out Cable



Exercise care to protect wire and cable from injury. When transporting in vehicles, see that wire and cable are not subjected to damage by tools or other equipment.

3. DISPENSING WIRE OR CABLE FROM REELS

3.01 To dispense E wire from a small reel, open top of carton and fold sides down to match holes in side of carton; then insert pipe or equivalent implement through holes in carton and hole in reel, using the carton as reel support (Fig. 4).

3.02 To pay out inside wiring cable from large or heavy reels it is necessary to use cable jacks or other suitable means for handling reels. Fig. 5 and 6 show two general methods. Note that the cable is payed out from the bottom; this puts a downward force on the reel instead of an outward one.

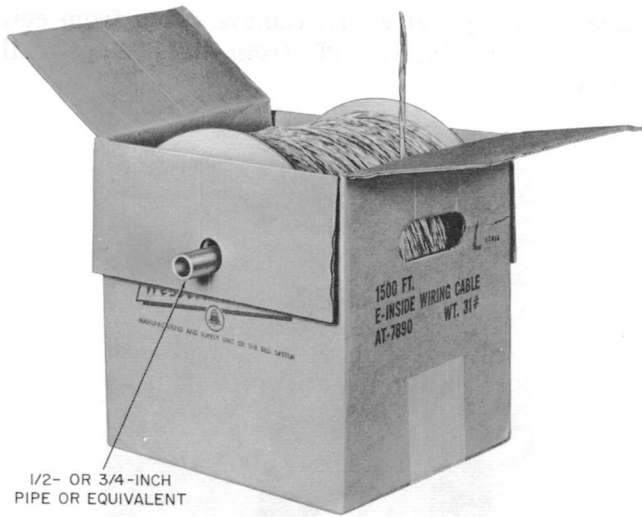

Fig. 4 — Carton Used as Reel Support

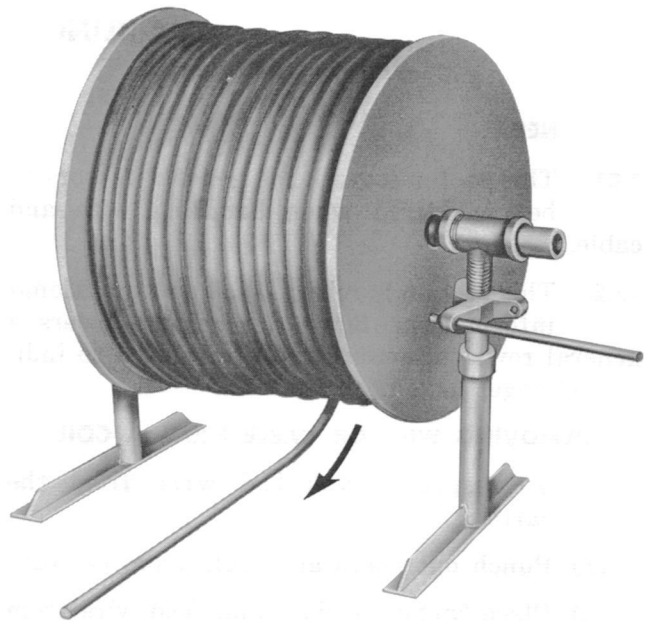
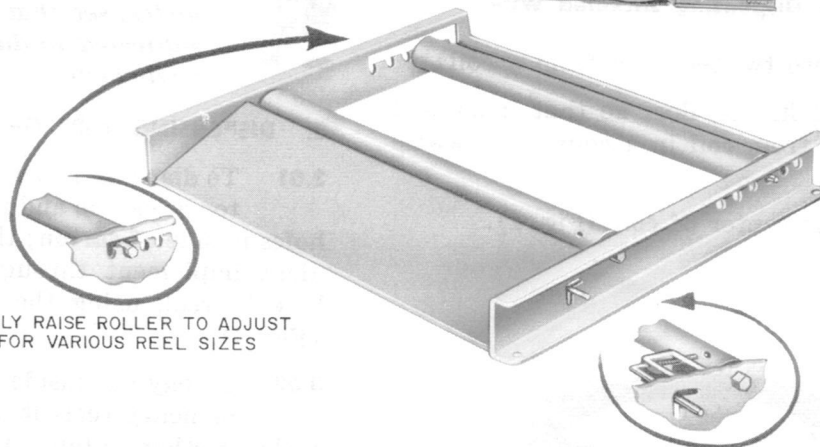
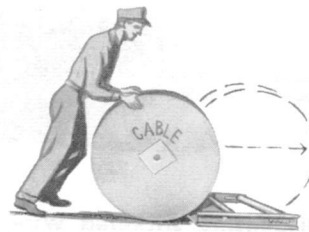
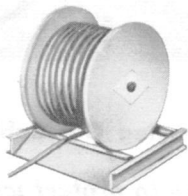

Fig. 5 — Reel Supported with Jacks



SIMPLY RAISE ROLLER TO ADJUST FOR VARIOUS REEL SIZES

SIMPLE, POSITIVE ROLLER LOCK MAKES REEL REMOVAL EASY

Fig. 6 — Reel Supported on Roller

4. STRIPPING CABLE

4.01 To strip plastic-covered inside wiring cable with jacket-splitting nylon cord:

- (1) Slit end of cable sheath with diagonal pliers for approximately 1 inch.
- (2) Locate jacket-splitting nylon cord under jacket.
- (3) Grasp cable firmly in one hand and, using long-nose pliers, pull nylon cord through cable jacket to the desired stripped length (Fig. 7).



Fig. 7 — Stripping IW Cable (with Jacket-Splitting Cord)

4.02 To strip braid or older plastic-covered inside wiring cable without jacket-splitting nylon cord:

- (1) Support cable between stripper and last attachment.

- (2) Hold cable stripper tool at angle to cable and insert point just under outer covering.
- (3) Pull stripper toward free end of cable (Fig. 8).

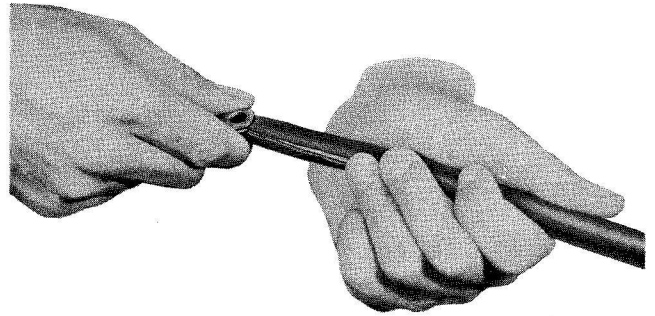

Fig. 8 — Using Cable Stripper

4.03 To strip lead-covered cable:

- (1) Score a groove around cable at butt marks with a chipping knife.
- (2) Cut deep enough so sheath will break when bent.
- (3) Slide section of sheath off free end of cable.
- (4) When a long section of sheathing is to be removed, score in short (approximately 4-inch) lengths and remove each separately.

5. STRIPPING JACKETED WIRE

5.01 To strip SK station wire:

- (1) Slit end of jacket with diagonal pliers for approximately 1 inch.
- (2) Locate jacket-splitting nylon cord under jacket.
- (3) Grasp wire firmly in one hand and, using long-nose pliers, pull nylon cord through jacket to the desired stripped length (Fig. 9).

5.02 Stripping JKT station wire (Fig. 10).

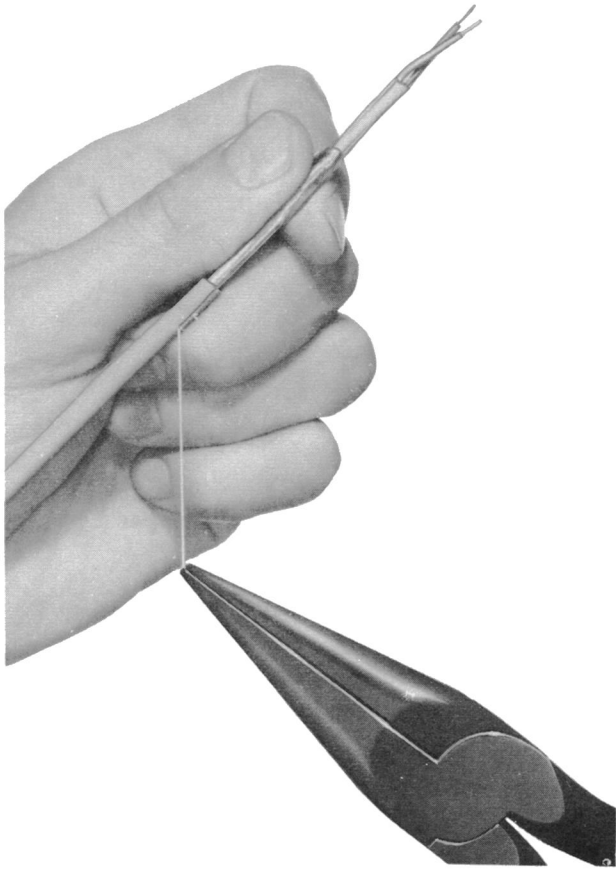

Fig. 9 — Stripping SK Wire

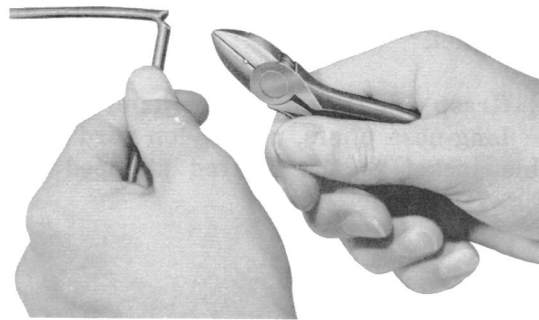
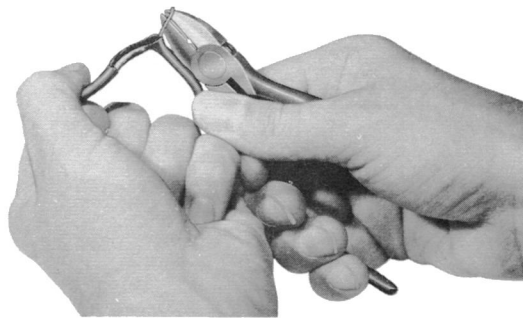

Fig. 10 — Stripping Jacketed Wire



6. SKINNING CONDUCTORS (Fig. 11, 12, and 13)

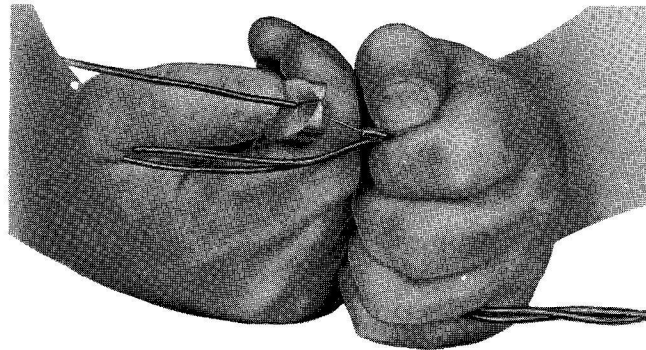

Fig. 11 — Skinning Twisted Wire

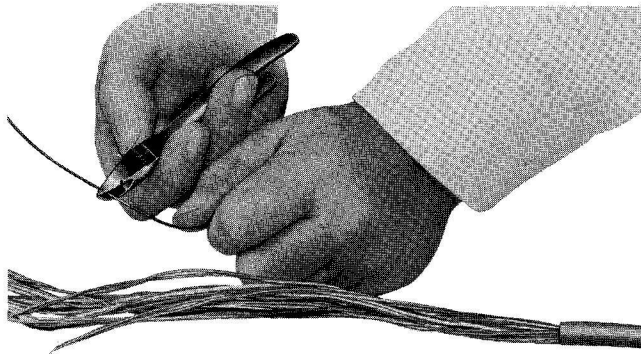

Fig. 12 — Skinning Conductors of Inside Wiring Cable

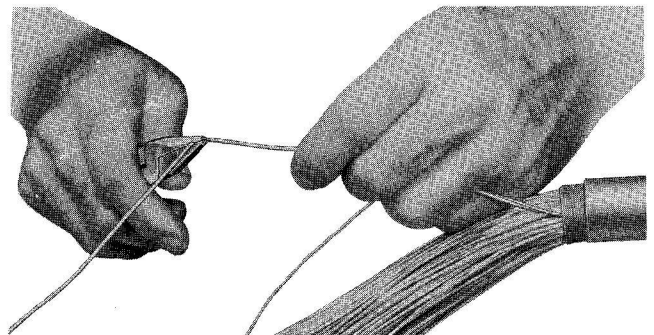

Fig. 13 — Skinning Conductors of Lead-Covered Cable

HANDLING WIRE AND CABLE

1. GENERAL

1.01 This section covers the general factors to be considered when handling wire and cable.

1.02 This section is reissued to show additional information and delete information covered in other sections.

2. REMOVING WIRE OR CABLE FROM A COIL

2.01 To dispense jacketed wire from the carton:

- (1) Punch out perforated hole from carton.
- (2) Place carton on floor and feed wire from center of coil (Fig. 1).

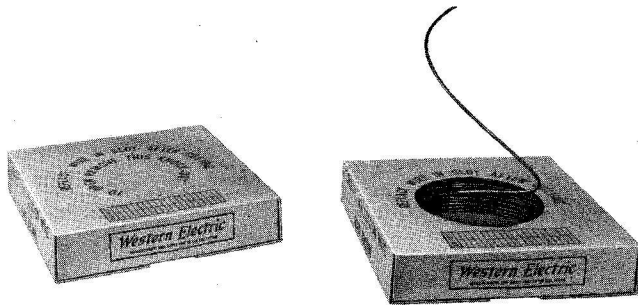

Fig. 1 — Dispensing Jacketed Wire

2.02 To dispense twisted wire from a coil:

- (1) Place coil flat on floor so that inner end will feed from coil in a counterclockwise direction.
- (2) Feed from center of coil (Fig. 2).

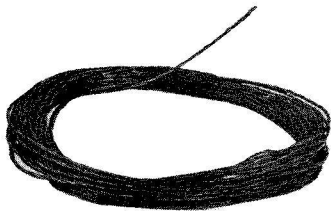

Fig. 2 — Dispensing Twisted Wire

2.03 To pay out cable, remove cable from coil by paying it off from outside of coil (Fig. 3).

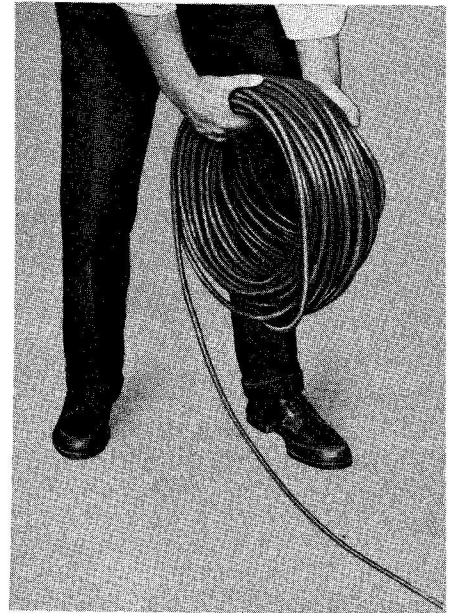

Fig. 3 — Paying Out Cable

3. DISPENSING WIRE OR CABLE FROM REELS

3.01 To dispense E wire from a small reel, open top of carton and fold sides down to match holes in side of carton; then insert pipe or equivalent implement through holes in carton and hole in reel, using the carton as reel support (Fig. 4).

3.02 To pay out inside wiring cable from large or heavy reels it is necessary to use cable jacks or other suitable means for handling reels. Fig. 5 and 6 show two general methods. Note that the cable is payed out from the bottom; this puts a downward force on the reel instead of an outward one.



Fig. 4 — Carton Used as Reel Support

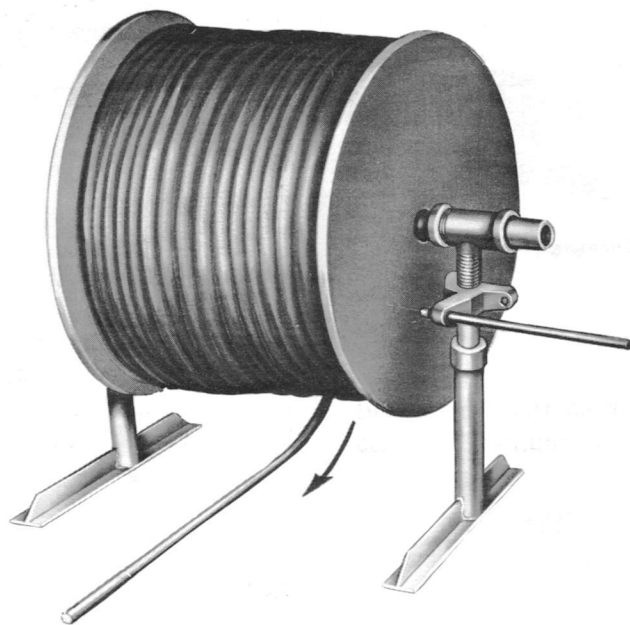

Fig. 5 — Reel Supported with Jacks

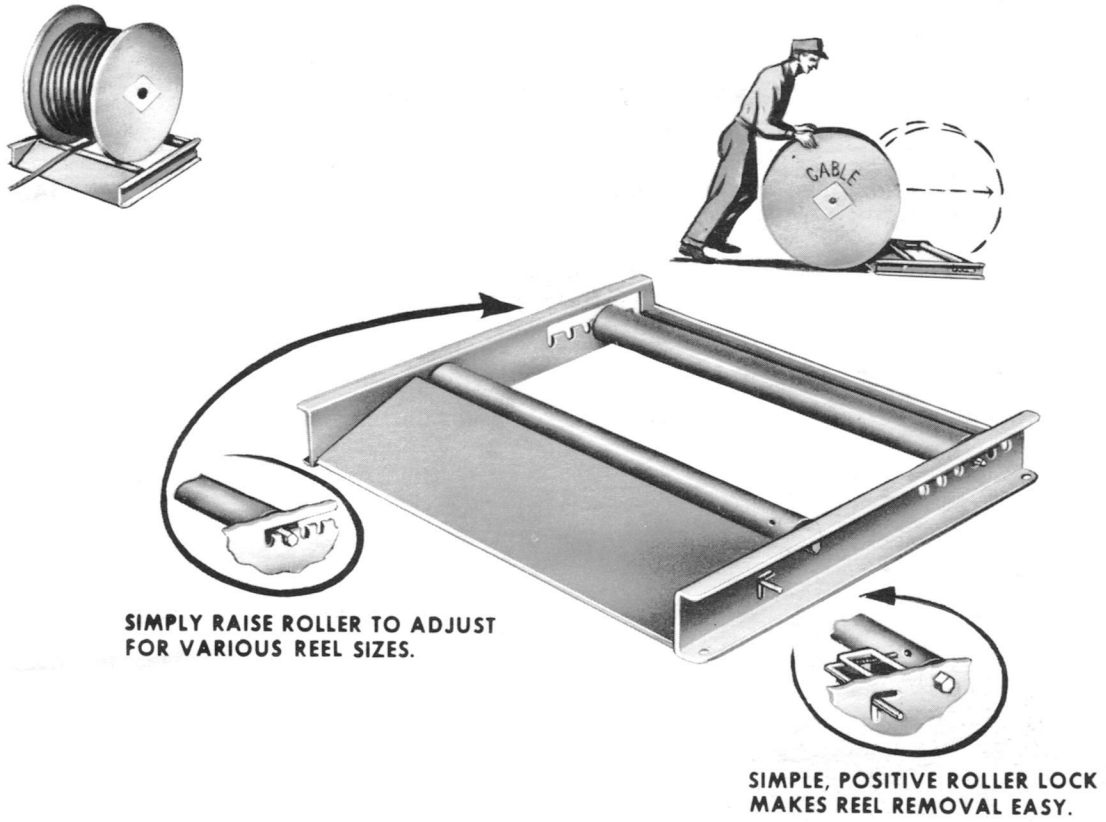

Fig. 6 — Reel Supported on Roller