



PagePac[®] Plus System

Installation and Configuration

Contents

General Information - 2
Before You Start - 3
Installation Steps - 4
Connecting Speakers - 9
Power Up System - 12
Self Powered Controller - 13
Troubleshooting - 20
Specifications - 23
Controls and Indicators, Terminals and Connectors - 24
Connectivity Chart - 26
Programming - 28
Quick Reference Charts - 48
Zone Map and Configuration Tables - 51
Application Notes - 57

Notice

Every effort was made to ensure that the information in this guide was complete and accurate at the time of printing. However, information is subject to change. Certain features described in this guide may not apply to earlier versions of the PagePac Plus System.

FCC Statement (Part 15) - Radio Frequency Interference

The PagePac Plus System generates and uses radio frequency energy and if not installed and used in strict accordance with the manufacturer's instructions, may cause interference to radio and television reception. Testing is being conducted for compliance with the limits for a Class A device in accordance with the specifications in Part 15 of the FCC Rules and Canadian D.O.C. regulations. This testing is designed to provide reasonable protection against such interference. However, there is no guarantee that interference will not occur in a particular installation. If this equipment does cause interference to radio or television reception, which can be determined by turning the AmpliCenter unit off and on, the user is encouraged to try to correct the interference by one or more of the following measures:

- Reorient the radio or TV receiving antenna.
- Relocate the AmpliCenter unit with respect to the radio or TV receiver or vice-versa.
- Plug the AmpliCenter unit into a different outlet so that it and the radio or TV receiver are on different branch circuits.

If necessary, the user should consult the dealer or an experienced radio/television technician for additional suggestions. The user may find the following booklet, "How To Identify and Resolve Radio-TV Interference Problems," helpful. This booklet was prepared by the Federal Communications Commission (FCC) and is available from the U.S. Government Printing Office, Washington, DC 20402. Stock order No. 004-000-00345-4.

Trademarks

PAGEPAC, PAGEPAC PLUS and AMPLICENTER are trademarks of Harris Corporation. Centrex is a registered trademark of AT&T.

Ordering and Reference Information

The order number for this book is 463-248-202. To order copies of this book, call:

1-800-432-6600 in the U.S. and
1-800-255-1242 in Canada.

For related product information, refer to the *PagePac Plus AmpliCenter Installation and Use Guide*, and the *PagePac Plus Zone Expansion Unit Installation and Use Guide*.

Important Safety Information

Always follow these basic safety precautions when installing and using the system:

1. Read and understand all instructions.
2. Follow all warnings and instructions marked on the product.
3. DO NOT block or cover the ventilation slots and openings. They prevent the product from overheating. DO NOT place the product in a separate enclosure or cabinet, unless proper ventilation is provided.
4. Never spill liquid on the product or drop objects into the ventilation slots and openings. Doing so may result in serious damage to the components.
5. Repair or service must be performed by a factory authorized repair facility or AT&T technician.
6. The product is provided with a UL-CSA approved, 3-wire ground type plug. This is a safety feature. DO NOT defeat the safety purpose of the grounding type plug. DO NOT staple or otherwise attach the AC power supply cord to building surfaces.
7. DO NOT use the product near water or in a wet or damp place (such as a wet basement).
8. DO NOT use extension cords. The product must be installed with 6 feet of a grounded outlet receptacle.
9. DO NOT install telephone wiring during a lightning storm.
10. DO NOT install telephone jacks in a wet location unless the jack is specifically designed for wet locations.
11. Never touch uninsulated wires or terminals, unless the line has been disconnected at the paging or controller interface.
12. Use caution when installing or modifying paging or control lines.

Support Telephone Numbers

AT&T provides a toll-free customer Help line 24 hours a day.

In the U.S., call the AT&T NTSC Group at 1-800-552-3293 or the AT&T Help line at 1-800-628-2888 if you need assistance when installing, programming, or using your system. For service or technical assistance in Canada, call one of the following Technical Assistance Centers

Eastern Canada and Ottawa:	1-800-363-1882
Ontario:	1-800-387-4268
Central and Western Canada:	1-800-663-9817

Domestic and International Approvals

U.L. 813, U.L. 1459 Paragraph 2.1., C.S.A.-22.2 No. 225-M90, F.C.C. Part 15, F.C.C. Part 68, D.O.C.

Before You Start

Before installing your system, read and understand the safety instructions that follow. Be sure you have all the necessary parts, tools, and test equipment, listed below.

1

Read Important Safety Information on Page 2

2

Check Shipping Container Contents

- Controller Unit, including plastic snap on cover
- Mounting hardware (screws and brackets)
- Cables, a non-standard modular to modular cord (do not substitute), and 8-pin Molex (See note 1)
- This Installation and Configuration guide

NOTE 1: This cable is only supplied with the standard (non-powered) Controller.

NOTE 2: These items are only supplied with the Controller with power supply.

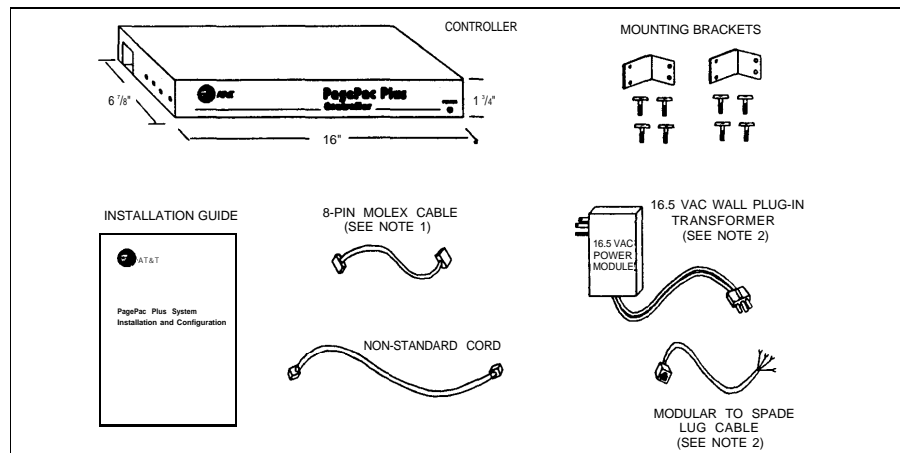

Figure 1. Controller Components

3

Have Required Tools

The following tools are required for the installation of the system hardware and cabling.

- Phillips screwdriver (small and large)
- Standard blade screwdriver (small and large)
- Wire strippers (24 AWG -12 AWG)
- Telephone test set (optional, for troubleshooting)
- Tone out circuit tester (optional, for troubleshooting)
- Portable 70V speaker (use cabling pulled for ceiling speakers) (optional, for troubleshooting)
- Volt-Ohm Meter (optional, for troubleshooting)
- 4 wood screws, if mounting on wall

Installation Steps

1

Mount the PagePac Plus Controller and Zone Expansion Units, if any, to either a wall, cabinet or a rack (below the AmpliCenter or other amplifier).

NOTE: When installing the PagePac Plus Controller, leave at least four inches space above and below for proper ventilation.

Install the paging equipment in a ventilated room where there is easy access to speaker cabling (preferably in the telephone equipment room).

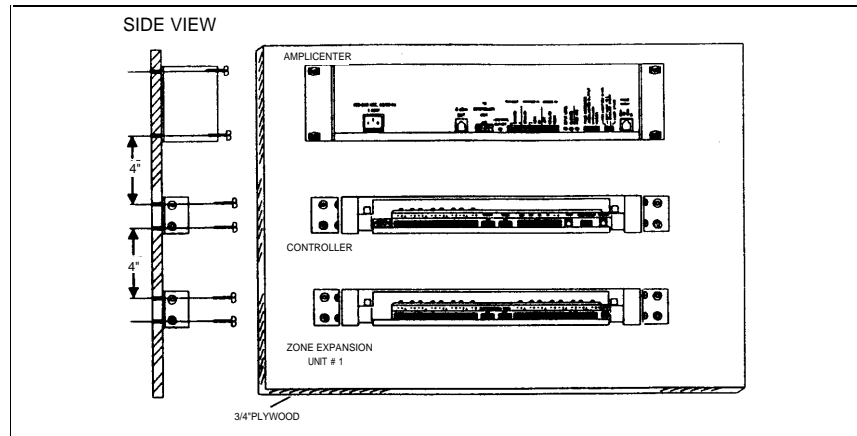

Figure 2. Wall Mounted Hardware

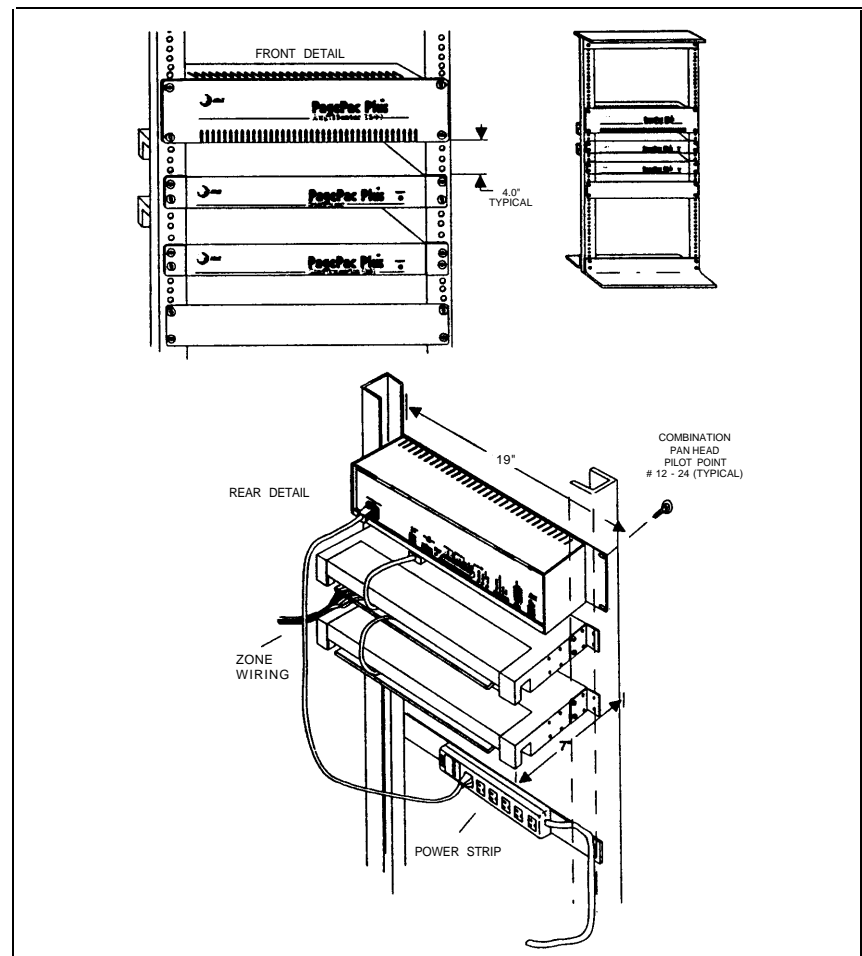

Figure 3. Rack Mounted Hardware

2

Connect background music input wires to Left and Right terminals if stereo, or, Left and Ground if not.

NOTE: The optional audio source can be a CD or tape player, AM, FM, or commercial radio, or other audio device.

If more than one AmpliCenter is used in the paging system, each one can be connected to the same music source, or different audio device, if desired.

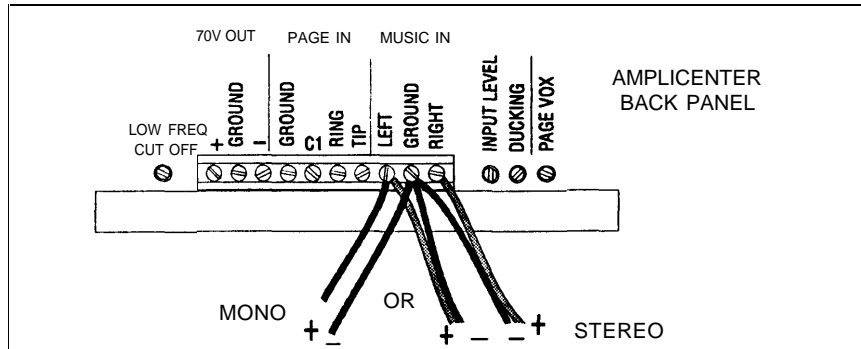

Figure 4. Music Input Connections on AmpliCenter

3

Plug modular cord into connectors "To Amp" on Controller and "Page In" on AmpliCenter.

NOTE: If an amplifier other than the AmpliCenter is used, refer to page 15. There you will find wiring diagrams and notes.

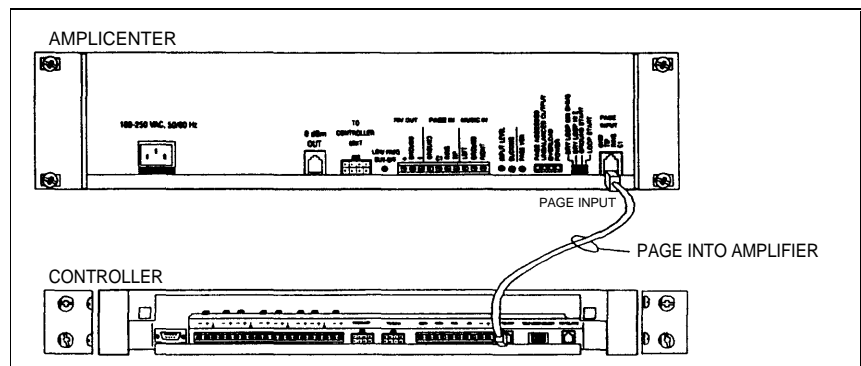

Figure 5. Page In Connection from Controller to AmpliCenter

4

Connect 8-pin Molex connector from AmpliCenter to Controller.

NOTE: Connectors can only go in one way. DO NOT force in.

If you are using another type of amplifier, refer to the example system setups on page 15.

CAUTION: Damage to Controller will occur if the Molex connector (from AmpliCenter) is plugged into the right connector (This goes to Zone Expansion Units).

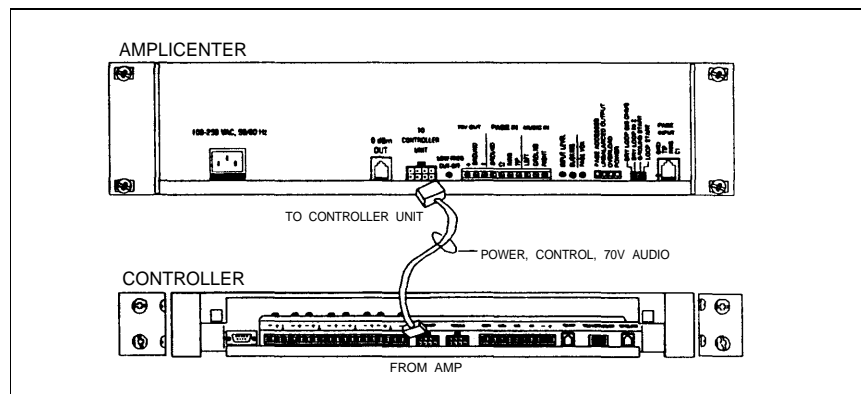

Figure 6. 8-pin Molex Connector from AmpliCenter to Controller

5 Set the AmpliCenter Telephone Mode Selection Switch to Dry Loop 600 Ohms (Far left setting).

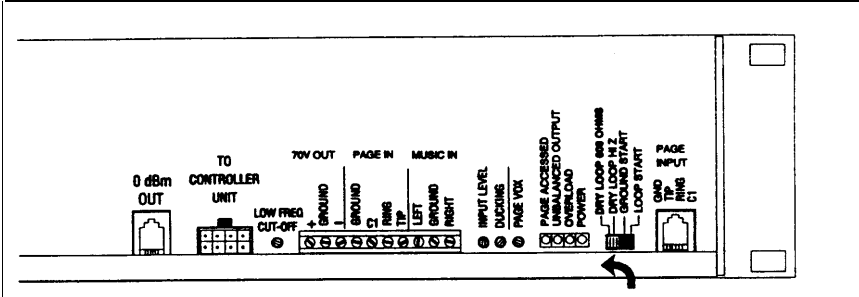

Figure 7. AmpliCenter Mode Switch Setting

6 Connect 8-pin Molex from Controller to Zone Expansion Unit(s), if used.

NOTE: Up to 3 Zone Expansion Units can be used, providing up to 56 paging and/or control zones.

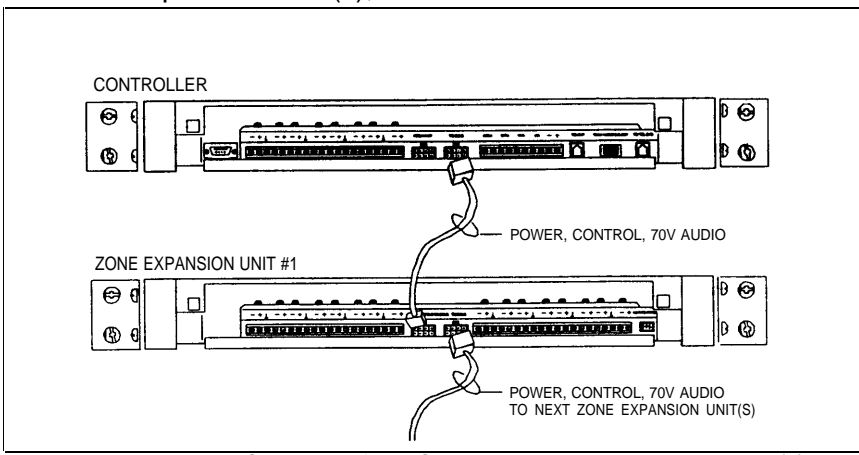

Figure 8. 8-pin Molex Connector from Controller to Zone Expansion Unit(s)

7 Set DIP switches on each Zone Expansion Unit, if any.

NOTE: These DIP switches must be set correctly in order for the Controller to recognize the additional zones.

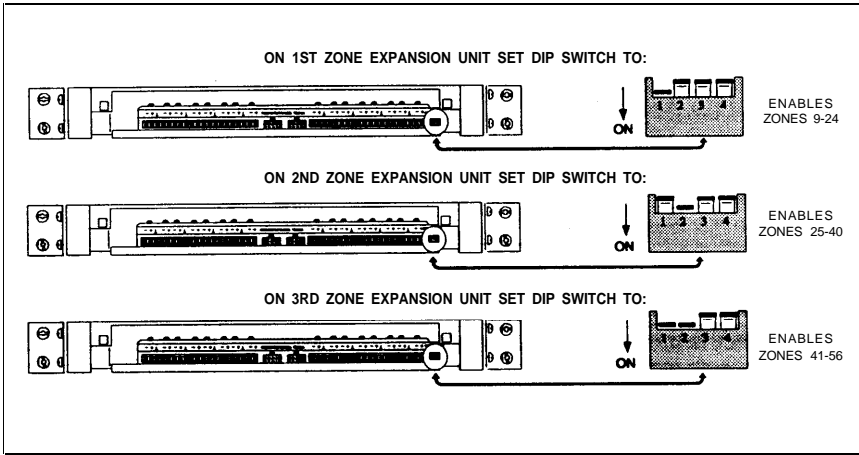

Figure 9. Setting Zone Expansion Unit DIP Switches

8

Make initial sound level adjustments on AmpliCenter.
Re-adjust (if necessary) after testing paging system.

Using a small standard screwdriver, make the following adjustments.

- ① Adjust the Low Frequency Cut Off control to center position. This control cuts out the low frequency bass so that horns and small speakers are not over-driven and distorted by excessive bass energy. Cut-off frequency is continuously adjustable from 50Hz (full CCW rotation) to 400 Hz (full CW rotation).
- ② Adjust the Page VOX (voice activated) sensitivity to the fully counter-clockwise position.
- ③ Adjust Music Input level to the center position. Clockwise rotation will increase the level. Listen and set to a comfortable level.
- ④ Adjust Music Ducking level to the fully counter-clockwise position. This feature allows music to continue to be heard during a page, but at a reduced level. The range is less than -40 dB (full CCW) to -6 dB (full CW). If music is not connected, set to full CCW.

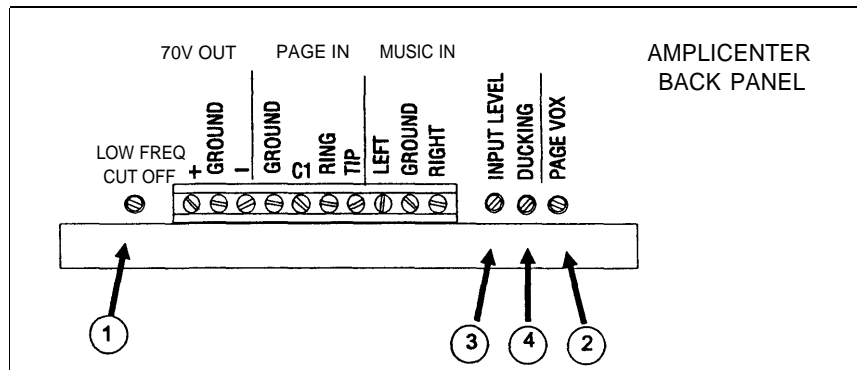

Figure 10. Sound Level Adjustments on AmpliCenter

9

Set Telephone Mode switch on Controller to match host telephone system interface port type.

NOTE: If the type of telephone system access port is not readily known, refer to the Connectivity Chart on page 26, or check with your telecommunications manager or telephone installer.

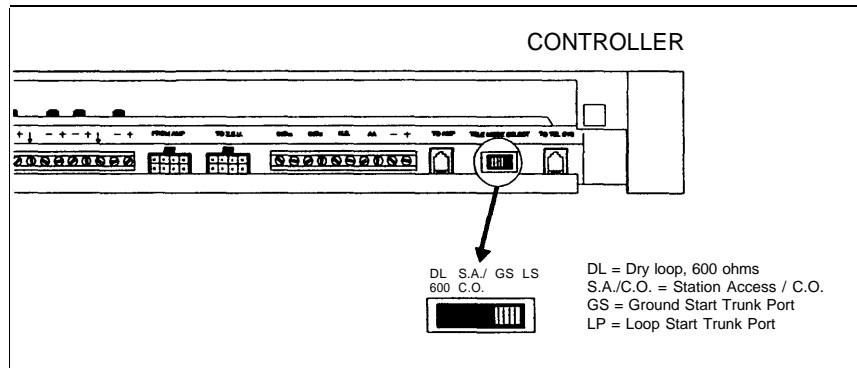

Figure 11. Setting Controller Telephone Mode Switch

10

Connect cable from host telephone system to Controller Page Input.

NOTE: Depending on the type of host telephone system interface port, the connection may differ slightly from the illustration to the right. A direct 4-conductor cord from the Controller to the telephone system can also be used, bypassing the connector block.

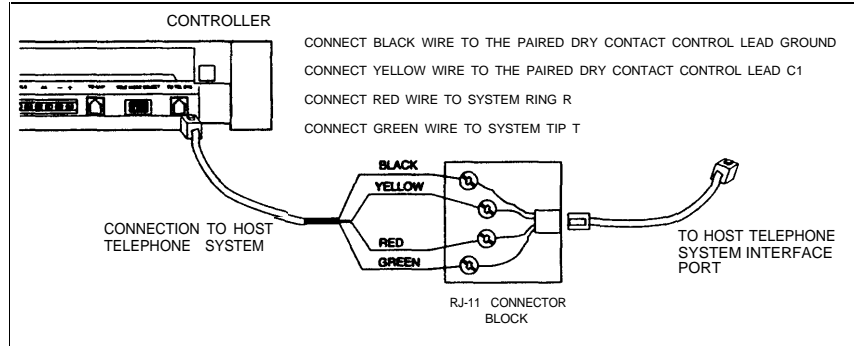

Figure 12. Connecting Host Telephone System to Controller

11

Connect two wires from the night bell analog station port on the host telephone system to Controller night bell (N.B.) input.

NOTE: If the host telephone system is an EKTS type, it will provide a contact closure for night bell. This night bell input is wired to one of the eight controller input zones, and programmed as such. The night bell ringing through the paging system is an optional feature.

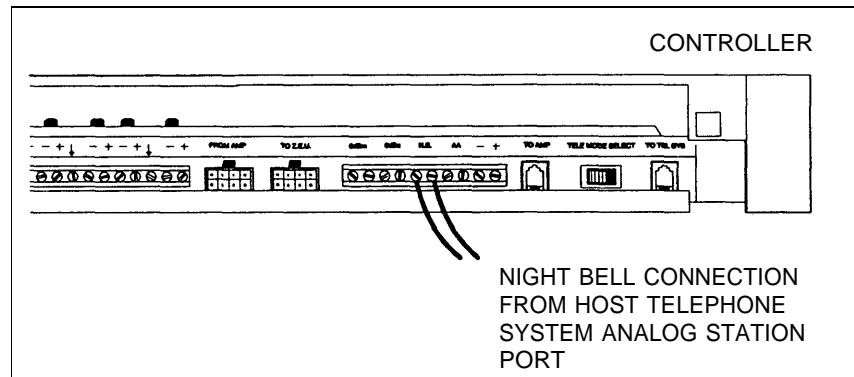

Figure 13. Night Bell Connection to Controller

12

Set the Zone Option switches on the Controller and Zone Expansion Units, if any.

NOTE: For each zone used, no matter what its function, this switch needs to be set to one of three settings for proper zone operation.

The Controller has eight switches for zones 1-8. Each subsequent Zone Expansion Unit has switches for zones 9-24, 25-40, and 41-56.

Refer to the Zone Map and Zone Configuration Tables filled out during facility paging system design. You can find these in the programming section on page 29.

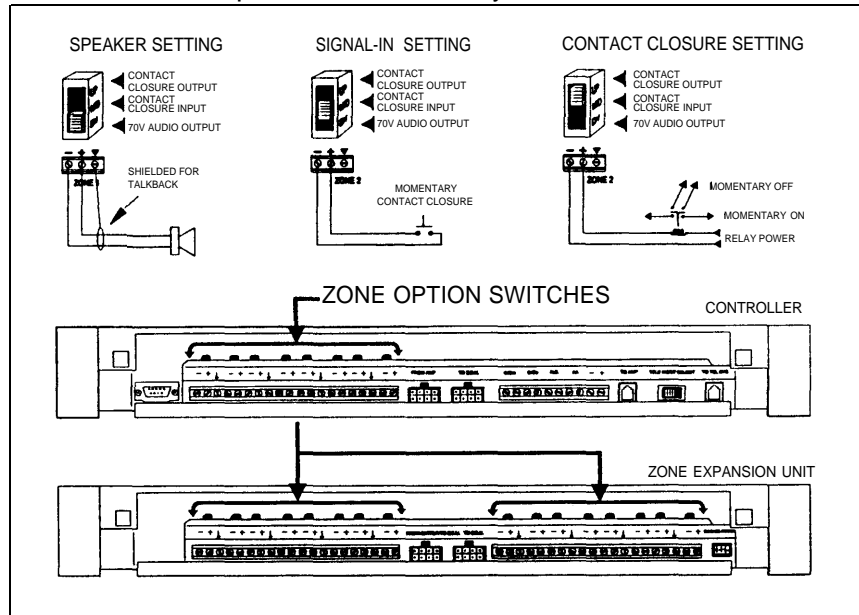

Figure 14. Setting Zone Option Switches on Controller and Zone Expansion Units

Connecting Speakers

1

Locate and mount all speakers in accordance with the floor plan drawing for this installation.

2

Connect each speaker to the appropriate Home Run or Speaker-to-speaker wiring scheme as shown on the floor plan.

NOTE: Adjust all speakers per volume and power requirements as noted on floor plan, during or after installation.

Figures 16 and 17, on the following pages, show wiring methods using local and zone connector blocks, and contact closure zone applications.

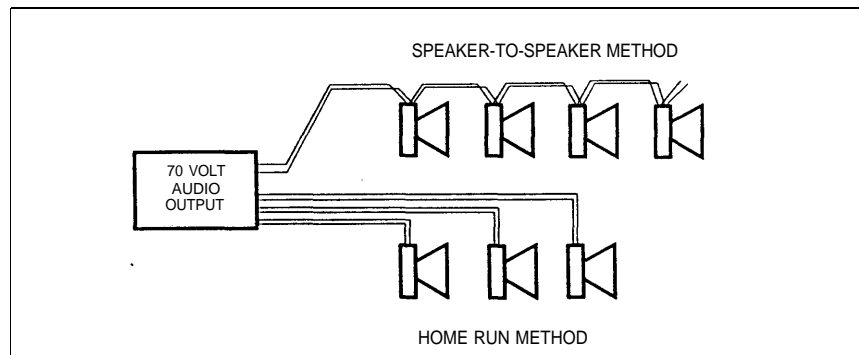

Figure 15. Speaker Wiring Methods

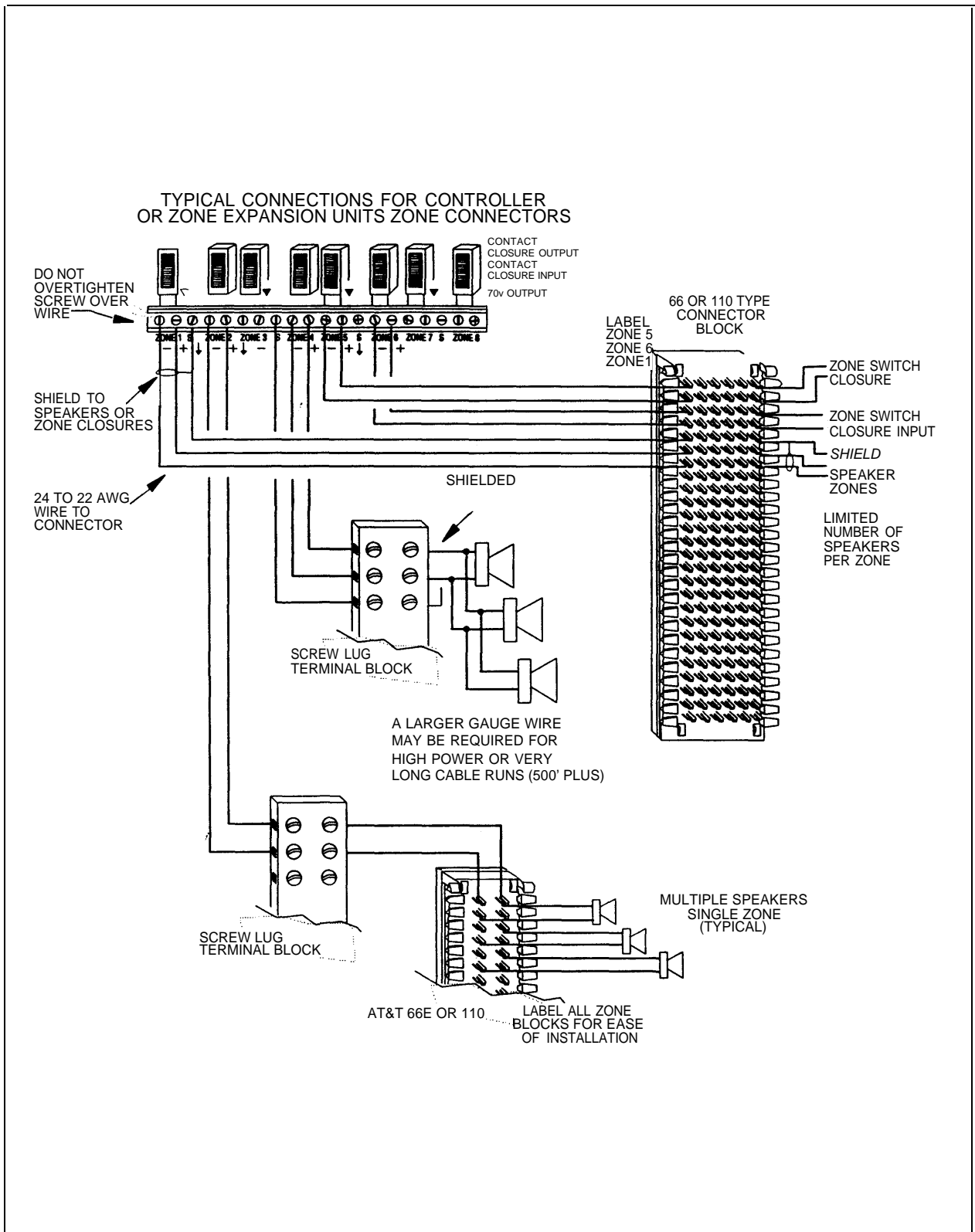

Figure 16. Zone Wiring Using Connector Blocks

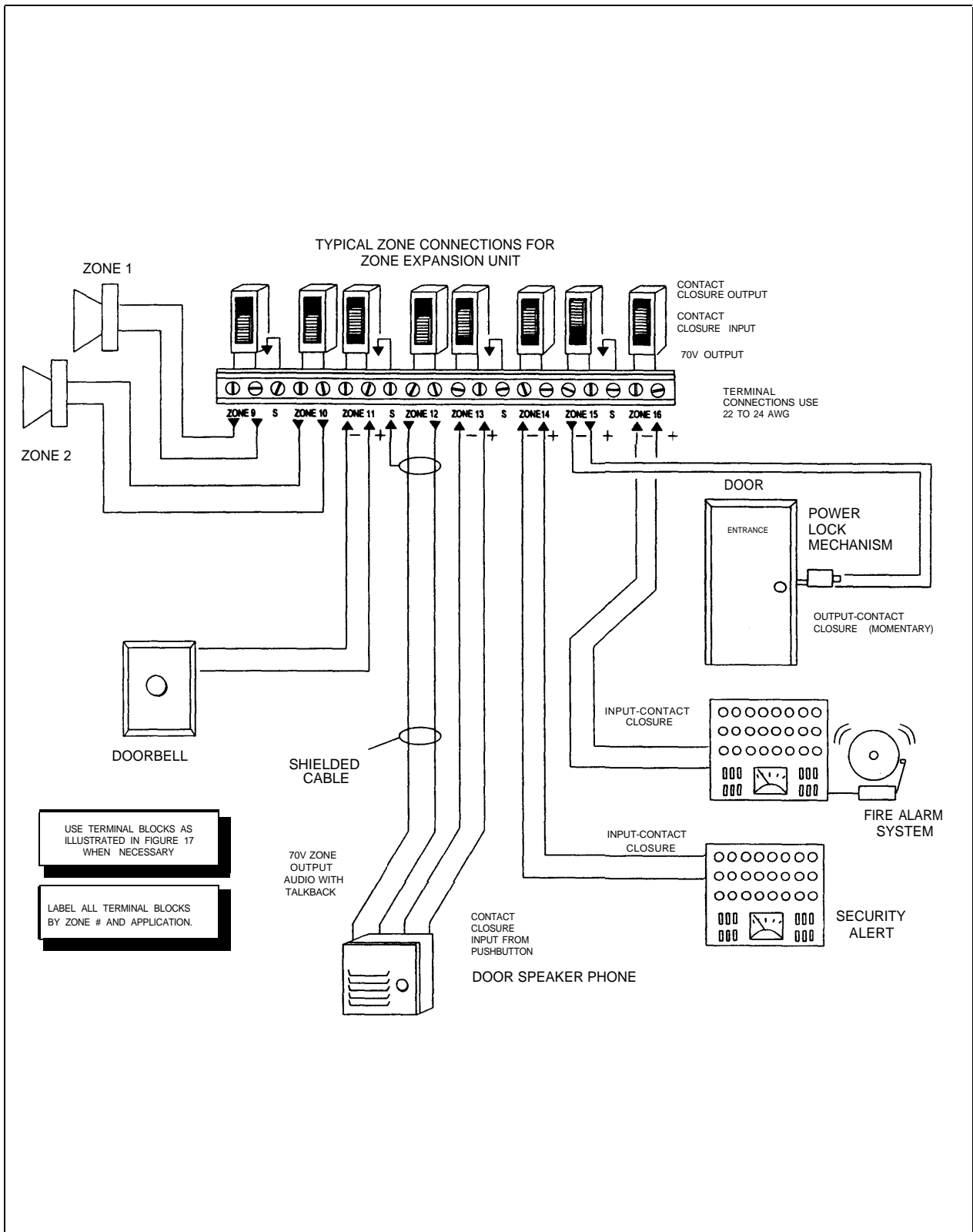

Figure 17. Contact Closure Zone Wiring to Controller

3

Test speaker wiring for short circuits

Measure the resistance of each home run wiring with an ohmmeter. Any pair indicating a value of less than 15 ohms must be rechecked for possible shorted wiring or speakers. Correct any problems and retest.

4

Make zone connections to Controller and any Zone Expansion Units. (See Figure 16)

The zone connectors on the Controller and Zone Expansion Units can accommodate up to two 22 AWG wires or four 24 AWG wires per zone output.

NOTE: DO NOT over tighten zone connector screws.

Check zone option switch setting with Zone Map and Zone Configuration Tables as you connect each zone (A 70V audio output setting going to other than speakers may damage other equipment).

Powering Up System

With all zones wired and connected to the Controller and Zone Expansion Units (if any), initial testing can begin. Refer to Figure 24, Controls and Indicators. Once initial testing is done, you can begin to program the Controller with the features for each zone.

1

Plug the power cord into the A.C. input connector on the AmpliCenter. The following should happen.

NOTE: If during power up, the system does not respond as described, refer to the Troubleshooting section

If an amplifier other than the AmpliCenter is used, make sure it is powered up and verify the Controller LEDs.

1. The green Power LED on the AmpliCenter will turn on and stay on.
2. The green Page Access LED on the AmpliCenter also turns on, but will go out after a few seconds.
3. On the Controller, verify that the green Phone System Enabled LED is off.
4. On the Controller, verify that the yellow Attendant Access Enabled LED is off.
5. If background music is connected, adjust the Music In Input Level control on the AmpliCenter(s) for an acceptable level.

Continued on next page...

2

Make an All Zone test page. Re-adjust sound levels, if required.

1. Re-adjust Music Input level to the center desired loudness relative to paging loudness.
2. Some loudspeaker taps may have to be re-adjusted to get even coverage at all locations. Be sure that the final speaker tap setting totals do not exceed the power rating of the AmpliCenter.

3

Begin programming the Controller (page 28).

Self-Powered Controller Connections

The PagePac Plus System consists of the Controller, AmpliCenter, and up to 3 Zone Expansion Units, providing up to 56 paging and/or control zones. The Self-powered Controller comes with its own power supply, enabling it to control paging and control zones utilizing a paging amplifier other than the AmpliCenter.

The following wiring diagrams illustrate the connection of the Self-powered Controller with other amplifiers. In this way, most features associated with the Controller can be utilized with amplifiers other than the AmpliCenter. Refer to Tables 1 and 2 for gain and sensitivity settings.

NOTE: If you are installing the “non-self-powered” Controller with the AmpliCenter, disregard the diagrams in Figures 18 through 22, and refer to the Installation Steps, previously described.

Controller to Generic Amplifier

NOTE: Refer to Tables 1 and 2 for proper audio input requirements and volume control settings.

- 1** Connect 0dBu or 0dBm output to amplifier audio input.
- 2** Connect Audio Output (70.7V) to Amplified Audio connector on Controller.
- 3** Adjust Controller volume control (See table 1)
- 4** If required, connect control input to amplifier from Controller zone set to "output contact closure."
- 5** Connect background music input, if any.
- 6** Connect host telephone system to Controller.
- 7** Plug power pack connector into Controller.

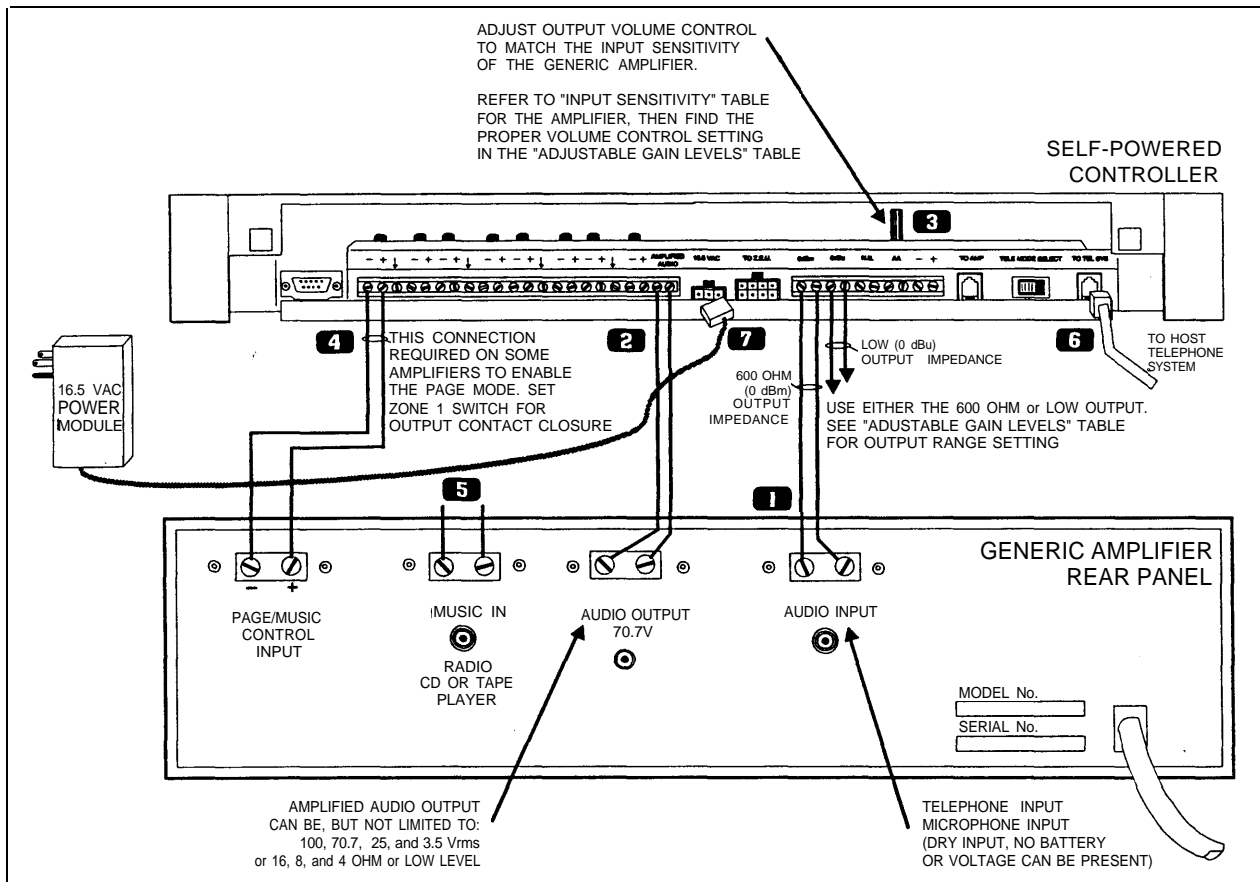

Figure 18. Connection of the Self-powered Controller to Generic Amplifiers

Table 1. Controller Adjustable Output Levels

Controller Volume Control Setting	600 Ohm Impedance Output	Low Impedance Output
Full Counter Clockwise	-12 dBm (195mV rms)	-6 dBu (388mV rms)
Full Clockwise	0 dBm (.775V rms)	+6 dBu (1.5V rms)

*NOTE: The generic amplifiers input must be dry, no battery or voltage can be present
 Condition: -12 dBm on the Telephone Interface or -12 dBu on the Attendant Access input, both outputs are terminated with 600 ohms.

Table 2. Input Sensitivity Levels for Amplifiers

Manufacturer	Model Number	Sensitivity
Carver Professional	PM 125	0.775V rms (22 kohm)
Bogen Communications Inc.	Gold Seal Series	Tel. Input Lo-Z Bal. 0.07V rms (600 ohm) or Power Amp "IN" 1V (High Z input impedance)
J.W. Davis & Company	DA-240P	Telephone: 600 ohm input impedance, 500mV
Crest Audio	CA6	0.775V rms (20 kohm input impedance)
AB International Power Amplifiers	Model 200 Model 400	0.775V rms (15 kohm input impedance) 1.5V rms
Chevin	A500	1V rms (10k input impedance)
Facusrite, Red Range	RED 5	1V rms (100k input impedance)
Compact Power	DS-300	0.5V rms (10k or 600 ohm)
CROWN	Com-Tech CT-200	0.775V rms (20k input impedance)
IED	Model 6000	0.9V rms (86k input impedance)
Clarity	SMA-60	200mV rms (600 ohm input impedance)
Alliance	PA20	Tel 150mV rms (600 ohm input impedance) or Aux 1 0.5V
University Sound, Inc.	A300	0dBu (15 kohm)

Controller to Amplified Speakers

- 1** Connect 0dBu output from Controller to Amplified Audio input to Controller.
- 2** Adjust Controller volume control to mid point.
- 3** Connect amplified speakers to each zone connector.
- 4** Set zone option switches to Amplified Audio Output.
- 5** Connect host telephone system to Controller.
- 6** Plug Power Pack connector into Controller.

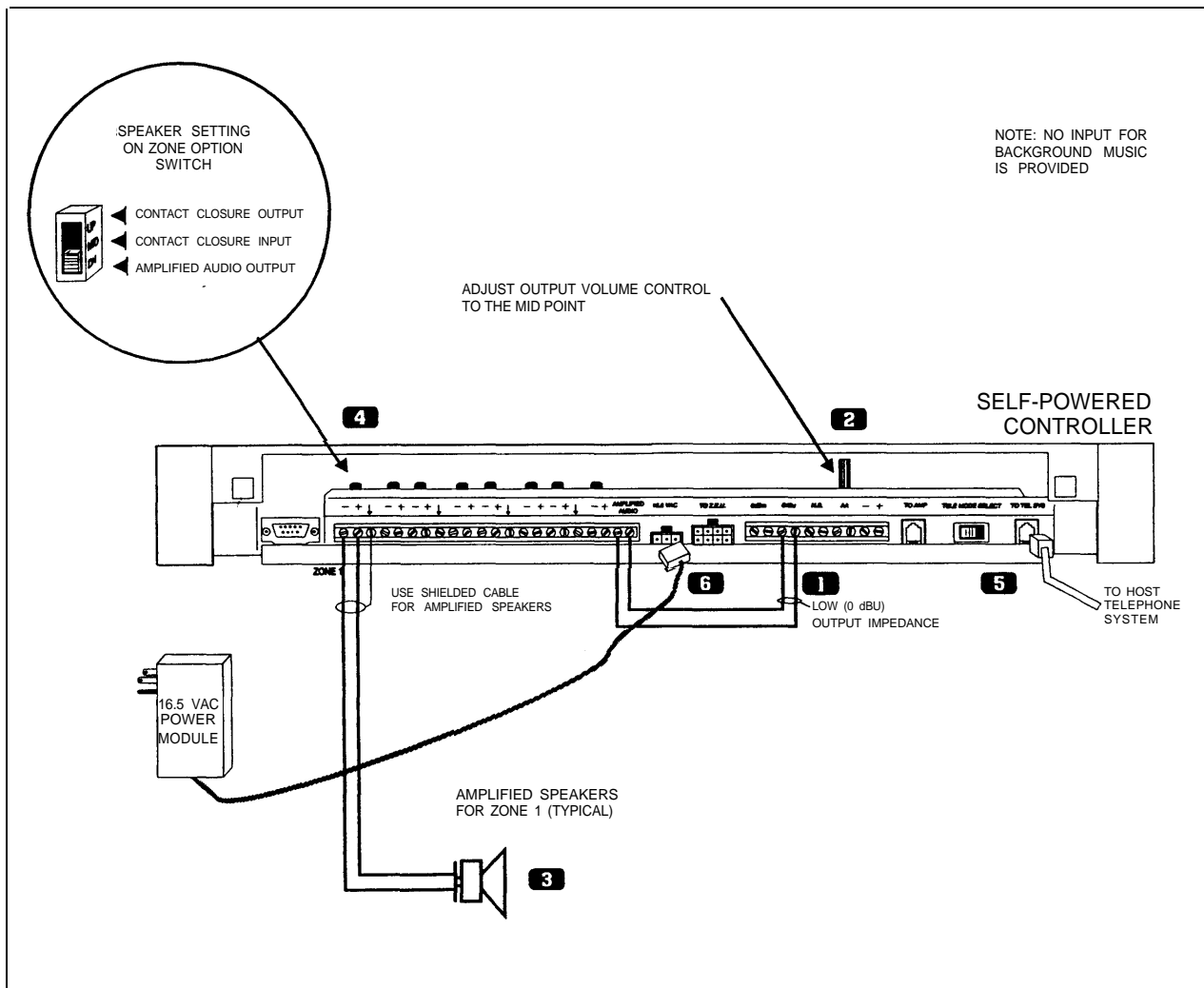

Figure 19. Self-powered Controller Driving Amplified Speakers

Controller to PagePac 20

- 1** Connect 0dBm un-balanced output from Controller to the modular to spade lug cable (green and red).
- 2** Adjust Controller volume control to full counter clockwise position.
- 3** Connect Controller zone contact closure output to the modular to spade lug cable (yellow and black).
- 4** Plug the 4-connector cable into PagePac 20 "Page Input" and to the modular to spade lug cable.
- 5** Connect audio output cable from PagePac 20 to Controller Amplified Audio input terminals.
- 6** Connect host telephone system input to Controller.
- 7** Plug power pack connector into Controller.

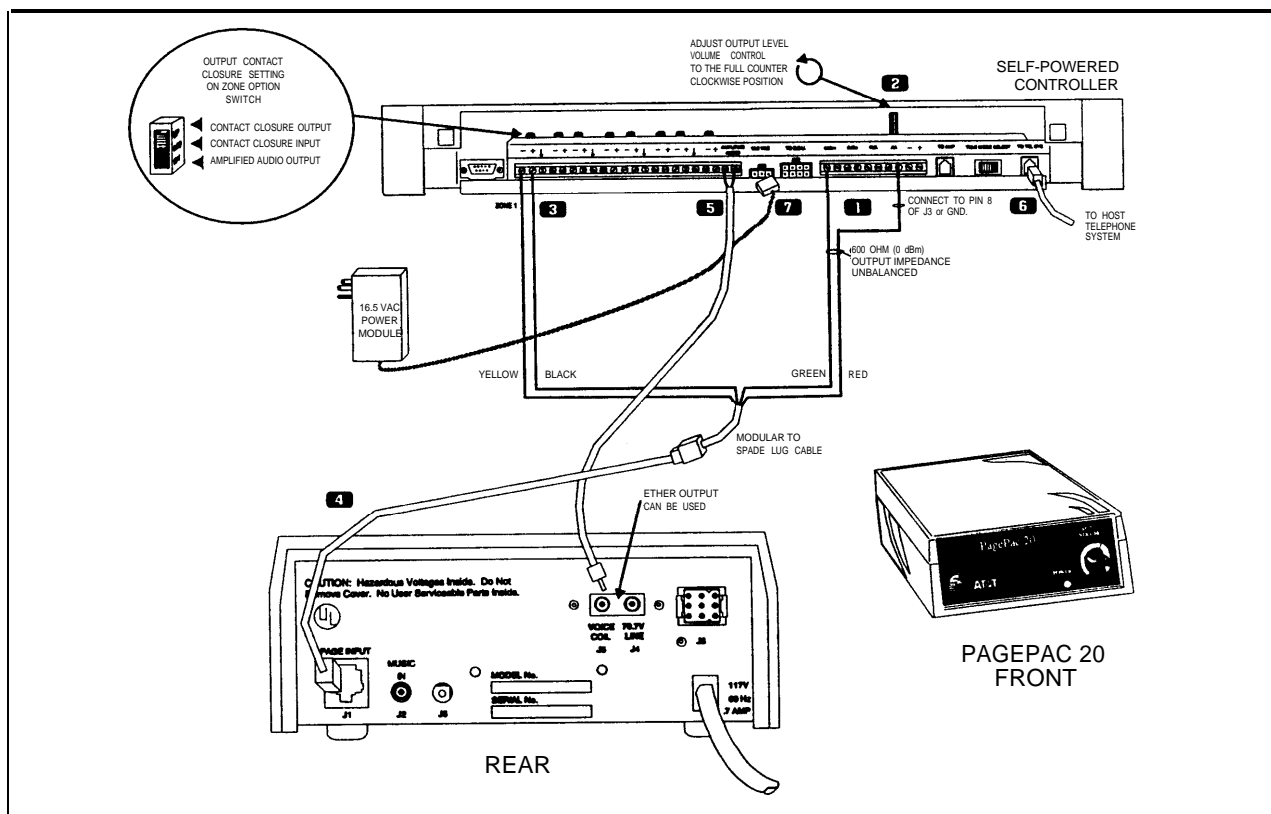

Figure 20. Self-powered Controller Connected to PagePac 20.

Controller to AmpliCenter 100

- 1** Connect the modular to spade lug connector from Controller (To Amp) to amplifier Page In (red and green), and to Music/Page (black and yellow) control.
- 2** Adjust Controller volume to counter clockwise position.
- 3** Connect 70V audio out from amplifier to Controller Amplified Audio terminals.
- 4** Connect host telephone system input to Controller.
- 5** Plug power pack connector into Controller

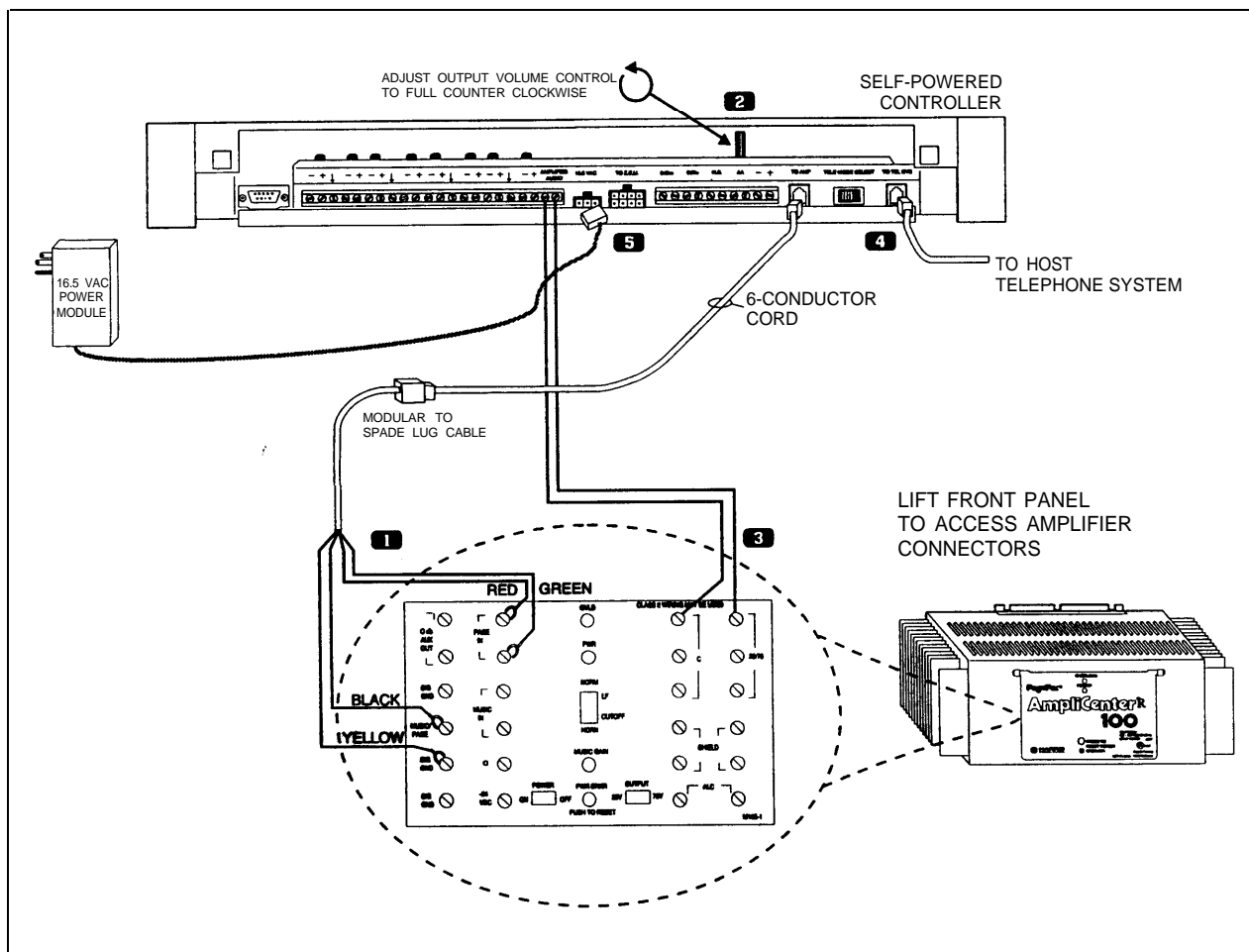

Figure 21. Self-powered Controller Connected to the PagePac AmpliCenter 50, 100, or 200

Controller to D-Series AmpliCenter

- 1** Connect 6-conductor cord from Controller (To Amp) to AmpliCenter Page Input.
- 2** Connect 70V audio out from AmpliCenter to Controller Amplified Audio terminals.
- 3** Connect host telephone system input to Controller.
- 4** Plug power pack connector into Controller.

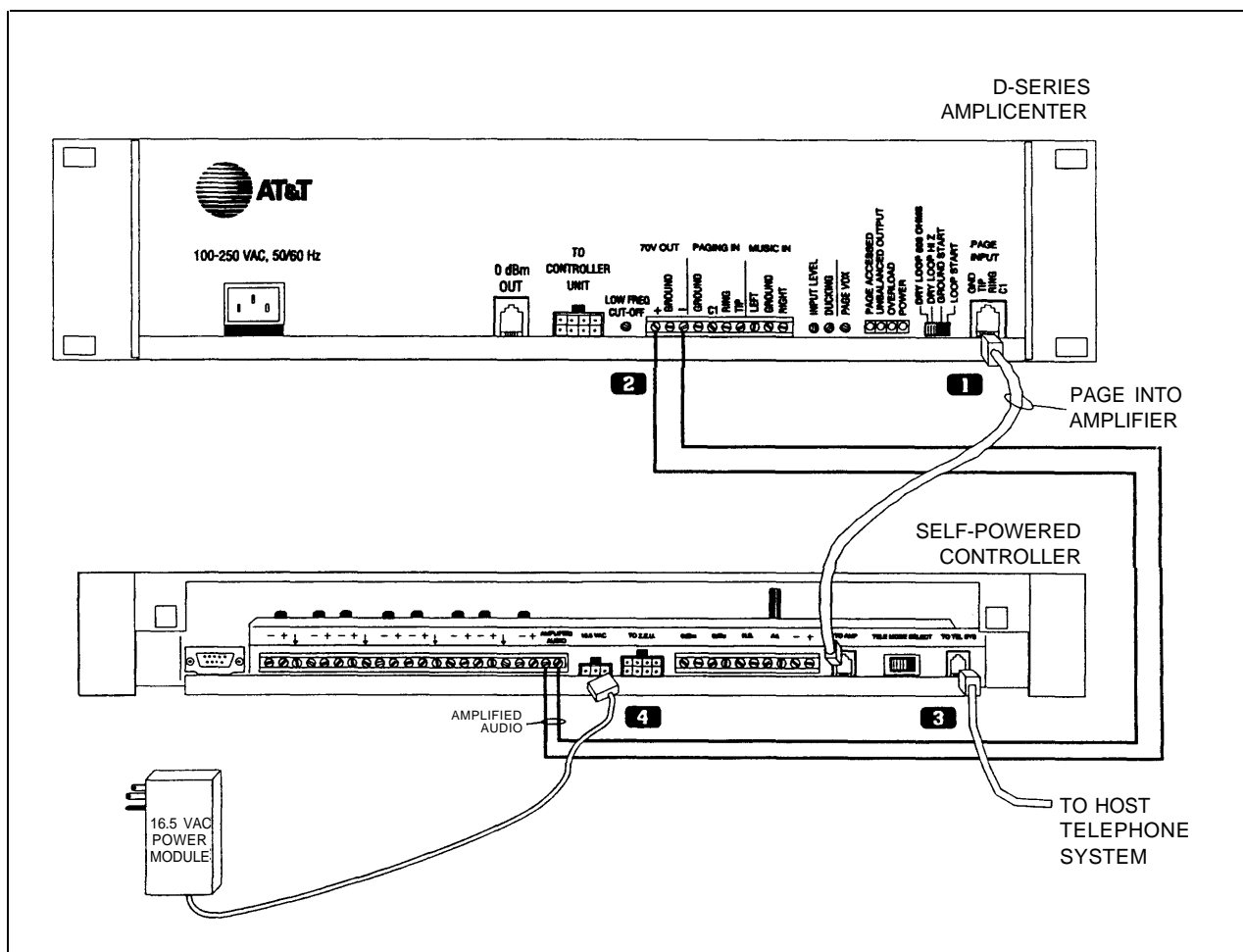

Figure 22. Self-powered Controller Connected to the PagePac D-Series AmpliCenter

Troubleshooting

Some common problems encountered when the paging system is not operating are described below. Check each item in the order listed.

1. No AC power to AmpliCenter or Controller
2. Host telephone system failure
3. Host system page port failure
4. A hardwire disconnect between host system and the Controller
5. AmpliCenter or Controller switch settings tampered with

If the problem has not been resolved by checking the preceding items, follow the steps described in the Troubleshooting tables that follows.

Table 3. Troubleshooting

Problem	Corrective Action
Power LED not on	Verify power cord is connected at both ends
	Check for AC voltage at the wall socket
	8-pin Molex plug from AmpliCenter in wrong connector on Controller
	AmpliCenter or Power pack Failed. Return for repair
Page access extension does not answer	No power to AmpliCenter
	Host telephone system not passing call through to Controller
	Telephone mode selection switch on Controller not set correctly
	Ground start - Tip and Ring reversed or Controller not grounded to host system
Background music cannot be heard	Input level not set correctly. Adjust music input level on AmpliCenter.
	No power to music source. Verify power is on.
	Radio off station. Adjust tuner.
	Most likely music input wires crossed, with signal grounded out.
	Music not programmed ON.
Distorted, garbled, or raspy sound from all speakers	Short circuited speaker leads. Separate.
	Music input level too high. Turn down.
	Speaker transformer shorted. Replace.
	Failed AmpliCenter. Return for repair.
Green power LED off	AC outlet receptacle is not live. Check outlet circuit breaker or use another outlet.
	Power cord is loose.
	Failed AmpliCenter. Return unit for repair.
Page access LED won't go off	Page VOX not set to full Counter Clockwise position
	C1 lead inadvertently grounded. If loop start or ground start, check that only 2 wires (Tip and Ring) are connected by the modular plug cord.
	Incorrect modular to modular cord connected between the Controller and the modular jack of the D-series AmpliCenter

Table 3. Troubleshooting (Continued)

Problem	Corrective Action
Talkback feature does not work.	Check the zone option switch, make sure that the switch is in the 70 volt position.
	Check programming options for proper settings.
	Check the telephone mode switch on the AmpliCenter is set to Dry Loop, 600 ohm mode
Noisy Talkback	Check the wire to see if shielded cable was used. Change to shielded if necessary.
	Make sure shield for cable is only tied to the Controller or Zone Expansion Unit end.
	Remove shield at speaker end.
Remote amplifier not receiving audio	Check audio connections on 0dBm or 0dBu
	Check the zone option switch is in the Contact Closure Output position
No music source connected to the input, but there is noise on the output in the music mode.	Turn the music input volume control to the full counter clockwise position (down)
	Check programming option to see if music is disabled to the zone(s).
No music heard with a music source connected to the input.	Check the-volume control level
	A higher priority in the Controller is active.
	Check the input and output connections.
	Check the programming options to see if music has been enabled to the zone(s).
Music volume is low when the volume control on the AmpliCenter is set to maximum.	Check the DTMF volume control level on the AmpliCenter
	Check the speaker tap settings.
	Page Access LED is on.
Night Bell is not active when it is intended to be activated with a ring voltage	The input voltage level is too low or missing (50V or greater)
	Make sure the the Controller input connections are to pins 5 and 6 of J3
	A higher priority in the Controller is active
Zone optioned as an "Contact Closure Input" is not functioning	Check the connections to the zone selected as the input zone.
	Check that the zone option switch is in the middle position.
	Using an ohmmeter, verify that a contact closure is being provided from the host equipment.
	A higher priority in the Controller is active.
	Check the programming options for the proper settings.
No "Phone System Enabled" LED is lit when the host system is attempting to access the Controller	Verify that the telephone mode selection switch is in the proper position for the host system interface port
	Check all the connections to J4 on the Controller.

Table 3. Troubleshooting (Continued)

Problem	Corrective Action
Relay chatter when Tip and Ring is connected to the Controller	Verify that the Telephone Mode Switch on the Controller is set correctly for the host telephone system.
A busy signal is returned when attempting to make a page when the Controller is in the Page Port Mode	Verify that the Telephone Mode Switch is in the "DL" position to match the host telephone system interface port.
	Verify Attendant Access is not active.
	Page port of host system is busy.
Cannot access Controller when Tel. Mode is Ground Start	Verify host Tel. system's ground is connected to terminal "G" of J3 on the Controller.
	Verify Tel. Mode switch on Controller is set to "GS" (ground start).
	Tip and Ring tel. interface connections may be reversed (Ring always more negative than Tip).
Controller answers a station call, then immediately hangs up	Telephone Mode switch has wrong setting. Set to the "SA" (station access) position to match the host telephone system interface port.
Dial tone or confirmation tone is sent to the speaker when the Controller has not been accessed.	The Telephone Mode switch position may have changed while connecting Tip and Ring wires.
Contact closure output is not functioning	Check connections to selected contact closure output zone.
	Verify Zone Option switch is in its back position for contact closure output.
	Use an ohmmeter to verify that a contact closure is being provided from the Controller.
	A higher priority access to the Controller is currently active.
	Verify programming options enable contact closure output for that zone.
Attendant Access is not functioning.	Check the connection to the Controller back panel, terminals 7, 8, 9, and 10 of J3
	Using an ohmmeter, verify that a contact closure is being provided from the host tel. system to activate page on the Controller.
No pre-announce tone or confirmation tone is sent to the output zone, but it is desired.	Verify programming options for that feature are enabled for that zone.

Controller Specifications

Table 6 describes the technical specifications of the Controller.

Table 6. Controller Specifications

Capacities:	<ul style="list-style-type: none"> ■ The Controller connects up to 8 zones of audio output (including talkback) and contact closure inputs or outputs.
Dimensions and Weights	<ul style="list-style-type: none"> ■ Height: 1.75 inches (4.4 cm) ■ Width: 16 inches (40.64) without brackets, 19 inches (48.3 cm) with brackets attached. ■ Depth: 6.875 inches (17.5 cm) ■ Weight: 3 pounds (6.6 kg)
Electrical:	
0 dBm Output	<ul style="list-style-type: none"> ■ Voltage: 0.388 Vrms (no load) Impedance: 600 Ohms
0 dBu Output	<ul style="list-style-type: none"> ■ Voltage: 0.388 Vrms (no load) Impedance: 11 Ohms
Page Compression Threshold	<ul style="list-style-type: none"> ■ -12 dBm at Tip/Ring and Attendant Access inputs.
Talkback Compression Threshold	<ul style="list-style-type: none"> ■ -15 dBm (measured at Tip/Ring).
Frequency Response Tip/Ring	<ul style="list-style-type: none"> ■ -3 dB ± 1dB at 350 Hz and 20 kHz
Frequency Response (Attendant Access)	<ul style="list-style-type: none"> ■ -3 dB ± 1dB at 200 Hz and 20 kHz
Talkback Sensitivity	<ul style="list-style-type: none"> ■ 138 mVrms at the 0dBm output (pins 1/2, J3); 4 mVrms at the 70.7 Vrms zone output
Talkback Compression	<ul style="list-style-type: none"> ■ -15 dBm ± 2dB measured at Tip and Ring
Telephone Interference:	
Dry Loop	<ul style="list-style-type: none"> ■ Impedance: 600 Ohms; Control Lead De-bounce: 50 msec.
Loop Start and Ground Start	<ul style="list-style-type: none"> ■ Impedance: 600 Ohms; Talk Battery: -24 VDC; Control Lead De-bounce: 150 msec.
Station/Centrex Access	<ul style="list-style-type: none"> ■ Impedance: 600 Ohms; Open Interval Protection: 1.2 seconds; Foward Disconnect: greater than 400 msec.
Attendant Access Interface	<ul style="list-style-type: none"> ■ Impedance: 40 KOhms (Balanced); 20 KOhms (Un-balanced) ■ Control Lead De-bounce: 50 msec.
Relay Contacts	<ul style="list-style-type: none"> ■ Control Contact Closure: Contacts are rated at 120VAC/50VDC and 1 Amp. ■ Audio Zone: Contacts are rated at 2 Amps.
Temperature Range:	<ul style="list-style-type: none"> ■ 0 to +40 deg. C. (32 to 104 deg. F) operational ■ -40 to +66 deg. C. (-40 to +150 deg. F) storage and shipment
Humidity Range:	<ul style="list-style-type: none"> ■ 5% to 95% (non-condensing) storage/shipment and operation
Altitude:	<ul style="list-style-type: none"> ■ Sea level to 10,000 ft. operational (1048 to 648 millibars); 40,000 ft. max. shipment
Air Pressure:	<ul style="list-style-type: none"> ■ 40,000 ft. max. shipment
Environmental	<ul style="list-style-type: none"> ■ Locate in an area free of excess moisture, corrosive gases, dust, and chemicals.
Interconnect Cable	<ul style="list-style-type: none"> ■ 8-position, 5 Amp contact rating, locking, keyed, 22 AWG wire, housing material 94V-2, U.L. and C.S.A. listed, providing 70.0 Vrms (4), common ground, +17 VDC and -24 VDC

Controls and Indicators, Terminals and Connector

Figure 23 shows the controls and indicators, terminals and connectors on the rear panel of the AmpliCenter, Controllers, and Zone Expansion Units. Table 4 identifies them by function.

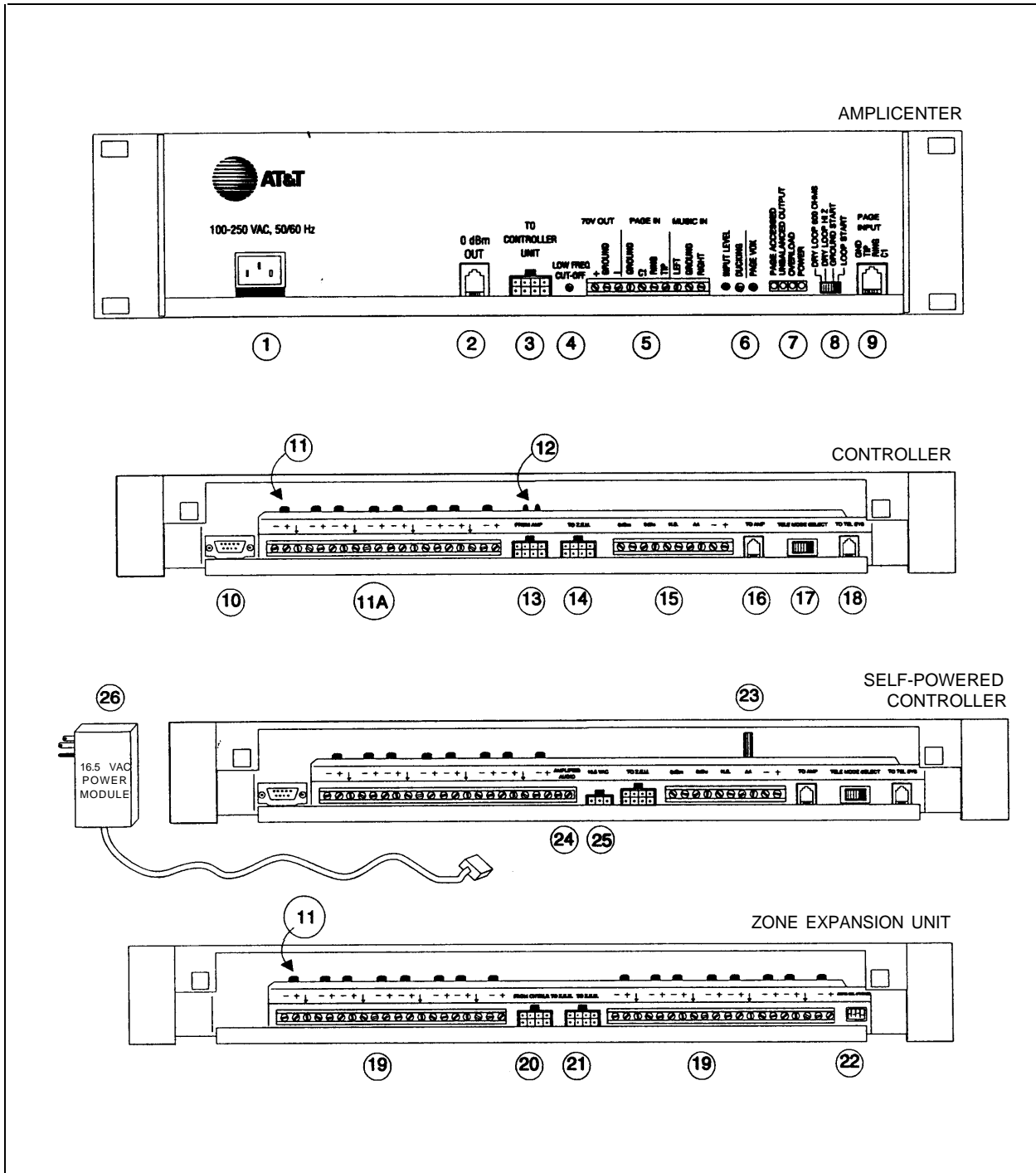

Figure 23. AmpliCenter, Controllers, and Zone Expansion Unit Back Panels.

Table 4. Controls and Indicators, Terminals and Connectors

1.	AC Power in: 105 – 125 VAC, 210 – 250 VAC, 50/60 Hz. (voltage auto-selectable within unit)
2.	0dBm out, an auxiliary output that differs from the main 70.7V output in that it is a low level (0dB), 600 ohm balanced output used for driving a remote or off-premises amplifier
3.	DC Power, and 70V audio out to standard Controller (Not used on self-powered Controller)
4.	Bass control screw-type adjustment pot. Attenuates low frequencies so that horns and small speakers are not overdriven by excessive bass energy. Cut-off freq. adjustable from 50 Hz (full CCW) to 400 Hz (full CW)
5.	Music In: left and/or right channels with ground; Paging In: redundant paging input (ground, C1, tip, and ring); 70V Out: Balanced output used for terminating the loudspeaker wiring
6.	Screw adjustable potentiometers: VOX sensitivity level, Music ducking (mute level for music during voice page), Music level for various music sources
7.	LEDs: green – power on, lights when AC line voltage is applied to AmpliCenter red – overload, lights when the AmpliCenter output exceeds its output power rating. This can occur when total speaker load is greater than the output rating, or when speaker wiring is shorted red – unbalanced output, indicates when one speaker lead is accidentally shorted to ground green – page accessed, lights when voice paging is active
8.	Telephone system mode switch: dry loop 600 ohms, dry loop Hi Z, ground start, or loop start
9.	Page input from host telephone system or Controller 6-conductor cable (see item 16): paging audio and control
10.	DB9 connector, RS-232 PC interface port, used for PC programming of Controller and PC monitoring
11.	Zone option 3-position slide switch: 70V audio out, contact closure input, contact closure output
11A.	Zone connector for zones 1-8, plus, minus, and ground screw down terminals
12.	LEDs: Yellow-attendant access active; Green-telephone access active
13.	8-pin Molex connector: DC power, control, and 70V audio from AmpliCenter
14.	DC power, control, and audio 70V output to next Zone Expansion Unit
15.	10-position connector: terminals 1/2 0dBm (600 ohm), terminals 3/4 0dBu output to other equipment, terminals 5/6 night bell in, terminals 7/8 control closure for attendant access input, terminals 9/10-audio source (mic) attendant access input
16.	Audio and control to AmpliCenter 6-conductor jack, item #9
17.	Telephone Mode switch: Dry Loop, Station Access, Ground Start, and Loop Start
18.	Telephone System interface for PBX, KTS, or Centrex systems; standard 6-conductor jack
19.	Zone connector for expansion zones: plus, minus, and ground screw terminals
20.	8-pin Molex connector from controller: power, control, and 70V audio or previous Zone Expansion Unit
21.	8-pin Molex connector to additional Zone Expansion Unit power, control, and audio
22.	DIP switch to be set when one, two, or three Zone Expansion Unit(s) are used.
23.	Volume output control on self-powered Controller
24.	Amplified audio input terminals on self-powered Controller
25.	Power connector input for 16.5 volt power module on self-powered Controller
26.	AC power transformer to self-powered Controller: 120VAC, 60 Hz, 200 mAmp to 16.5 VAC

Connectivity Chart

The Controller Connectivity chart gives the interface requirements for the host telephone systems listed. This information is then used to set the telephone mode function switch on the PagePac Plus Controller.

Table 5. PagePac Plus Controller Connectivity Chart

	System 2000	Merlin Plus		Merlin 206/820		Merlin 1030/30/70		Merlin II		Merlin Legend	
Set Mode Switch To:	C.O. Line	C.O. Line	Page Port	C.O. Line	Page Module	C.O. Line	Service Module	C.O. Line	Analog Station	C.O. Line	Analog Station
Loop Start	Yes	Yes Note 1	-	Yes Note 1	-	Yes Note 1	-	Yes Note 1	-	Yes	-
Ground Start	-	-	-	-	-	-	-	-	-	-	-
Station Access	-	-	-	-	-	-	-	-	Yes Note 2	-	Yes Note 3
Dry Loop (600Ω)	-	-	-	-	-	-	-	-	-	-	-

	Spirit 308/616		Spirit 1224/2448	Partner Plus			Partner II		
Set Mode Switch To:	C.O. Line	Page Port	C.O. Line	C.O. Line	Analog Station	Page Port	C.O. Line	Analog Station	Page Port
Loop Start	Yes	-	Yes	Yes	-	-	Yes	-	-
Ground Start	-	-	-	-	-	-	-	-	-
Station Access	-	-	-	-	Yes Note 5,6	-	-	Yes Note 4,6	-
Dry Loop (600 Ω)	-	-	-	-	-	Yes Note 7	-	-	Yes Note 7

	System 25			System 75/G1/G3I Definity			System 85/G2		
Set Mode Switch To:	C.O. Line	Analog Station	Aux. Port	C.O. Line	Analog Station	Aux. Port	C.O. Line	Analog Station	Aux. Port
Loop Start	Yes	-	-	Yes	-	-	-	-	-
Ground Start	Yes	-	-	Yes	-	-	Yes	-	-
Station Access	-	Yes Note 4	-	-	Yes Note 4	-	-	Yes Note 4	-
Dry Loop (600Ω)	-	-	Yes Note 8	-	-	Yes Note 8	-	-	Yes Note 8

Continued on next page...

Set Mode Switch To:	Comkey 416, 718, 1434 and 2152		Horizon			Dimension		
	C.O. Line	Intercom	C.O. Line	Analog Station	Intercom	C.O. Line	Analog Station	Aux. Port
Loop Start	Yes	—	Yes	—	—	Yes	—	—
Ground Start*	—	—	Yes	—	—	Yes	—	—
Station Access	—	—	—	Yes	—	—	Yes	—
Dry Loop (600Ω)	—	—	—	—	—	—	—	Yes Note 7

NOTES:

— Indicates a non applicable connection

1. Pressing pound key twice (**##**) equals one pound key (**#**) to be sent to the Controller when dialing from a multi-button set.
2. The Station Pac must be a vintage C or later. In order for the Merlin II to send a forward disconnect, the station must be programmed as a AA/VMS station port.
3. The Station Pac must be a vintage C or later. In order for the Merlin Legend to send a forward disconnect, the station must be assigned to a Calling Group with a Group Type Generic VMI.
4. The Station Pac sends a forward disconnect signal
5. Release 1 does not send a forward disconnect, Release 2 sends a forward disconnect.
6. A single pair RJ-11 cord must be used to interface with the Controller.
7. A 2-pair RJ-11 cord must be used to interface with the Controller.
8. Use "909" Universal Coupler and a 2-pair cord.

* Ground Start trunk for tel. system must share a common ground with Controller page input ground.

The **Dry Loop 600 Ohm** is a four wire interface consisting of a dry audio pair with a 600 ohm impedance and a control pair. The page input is activated when the control pair receives a contact closure from the host equipment, connecting C1 to ground. The Dry Loop page input can also be activated by the presence of page input audio signals that exceed a set threshold. This threshold is set by the page VOX adjustment; clockwise rotation lowers the threshold and makes it more sensitive. Adjust by experimentation to account for various line loss and noise. This feature is beneficial for (amplified) microphone sources that don't have a Music/Page control contact, or for remote AmpliCenters.

Dry Loop Hi Impedance is used to interface with parallel multiple units. input impedance is 100K ohms. Otherwise, the same as the 600 ohm dry loop operation.

NOTE: Ground start interface requires common ground between paging input and telephone system by direct line or other common grounding methods.

The **Ground Start** mode is a two wire interface and has a 600 ohm input impedance. When a trunk is accessed, a momentary ground is sent to the ring-side of the pair by the host equipment, loop current is detected and the tip-side of the pair is closed. Disconnect supervision of the ground start mode is accomplished by monitoring the loop current.

The **Loop Start** mode is two wire interface and has a 600 ohm input impedance. The host equipment draws loop current from the talk-battery which is supplied by the AmpliCenter. Disconnect supervision of the loop start mode is accomplished by monitoring the loop current.

Programming the Controller

The Controller is programmed to enable each zone to have different zone features, if required. There are two ways to do the programming. One is via the RS-232 serial port on the Controller which is connected to a IBM compatible (DOS) PC using the optional programming software.

An advantage of using a PC to configure the Controller is that screens can be viewed on the monitor to aid in selecting the zones for various options. A re-programming of the entire system can be done before downloading the configuration to the controller, saving down time. Furthermore, the old configuration can be saved and used again.

The other method works via the telephone access port (like calling to make a page), which accepts only touchtone telephone keypad inputs (DTMF) tones. The Controller has the ability to retain all programming options in non-volatile EEPROM memory or as a .CFG (configuration) file on a personal computer.

Software Configuration Overview

The Controller is pre-programmed with certain default values when shipped. However, not all paging systems will have the same requirements, and therefore you may want or need to change the options on the system.

Some of the various programming configurations, which are presented in detail later in this section, include:

- The ability to option a zone as an audio output zone, as either of two levels of input zone, or as an output contact-closure zone.
- If a zone is optioned as a paging zone or a switch-closure zone, then other options are available, such as zone grouping.
- Zone groups and individual zones can be configured to perform a variety of functions such as page enabled/ disabled or talk-back enabled/disabled.
- If a zone is selected to be input, then options may be selected such as energizing an output switch-closure zone(s), whenever the input is active, or a selected tone can be sent out to selected zones whenever the input is active.
- If multiple zones are configured as inputs with the same priority (for example, two zones coded I-1), access will be granted on a first-come, first-served basis.
- Zone mapping is also permitted.

Programming Steps

CAUTION:

The Zone Option switches must be set before the system is powered up, and therefore before programming commences.

NOTE: Programming steps by PC are not described in this guide because the software comes with its own guide. Although, the you may find the feature descriptions helpful herein.

NOTE: If the wrong password is entered, you will not receive any confirmation tone or new dial tone. You can continue to enter digit strings (without hanging up) until the correct password is entered, or hang up and try again by re-accessing the paging system. In the event that the you forget the password, see "Forgot the Password?" in Step 5.

When powered up, the Controller polls the zones to determine how many (if any) Zone Expansion Units are present (see DIP switch settings). The Controller has the capacity to serially access up to 48 external zones.

The 8 Zone Option switches on the rear of the Controller unit *must* be set to match the zone option selected via programming. The slide switch for each zone must be manually set to Contact Closure (to switch on/off a device, such as a door security lock, remote amplifier, etc.), Input, or Audio Output, depending on the mode selected for each zone.

The 16 Zone Option switches on the Zone Expansion Unit *must* also be configured to match the zone modes you intend to program.

IMPORTANT! It is recommended that the paging zone decisions be made and filled in on the Zone Map and Configuration Tables, located on page 54, prior to setting zone option switches and programming.

The programming features are summarized in the Programming Quick Reference Charts located on page 49. If a feature of the system is not going to be used, bypass that programming step.

1

Enter Programming Mode

1. From any DTMF telephone in the system, dial the paging access extension.
2. Dial the Connect Password (if optional).

You will hear the paging system dial tone

3. Dial ★ ★

You will hear confirmation tone, then dial tone. Now programming may begin.

2

Reset to Factory Defaults

1. Dial 1 0

You will hear two beeps from the Controller

2. Dial 2 5 3 2 7

After a long pause, you will hear 3 beeps from the Controller. The controller is now set to factory default conditions.

3. Program the system options (refer to the following paragraphs).

You may exit the programming mode by dialing #

3

Define Length of ALIAS Numbers

This system option allows you to set the length (3 or 4 digits) of the ALIAS number field. The default is 2 digits. If you wish to assign ALIAS numbers to the paging zones, you must set the length parameter. The ALIAS number is the dialing extension for the zone. If no ALIAS numbers are used, the Physical Zone Code is the dialing extension for a zone.

This MUST be done before "Zone Map Option – Assigning ALIAS Numbers", later in this section.

First access the PagePac Plus system and enter the programming mode by pressing ★ ★ and then entering your Programming password (if optioned). You may exit the programming mode by dialing #.

1. Dial **2 0** to select this option.

Hear a DOUBLE beep.

2. Press **3** or **4** to set length of ALIAS numbers (number of digits dialed to reach paging zone).

Hear TRIPLE beeps.

3. To verify the setting, dial **2 1** and repeat step 2 above.

4

Set Connect Password

This feature will not become active until the first time you enter a password, via the programming mode. The factory default is NO password. The Connect password operates as a security block into the paging system, restricting paging access to authorized users.

NOTE: You may want to use a short Connect password (2 or 3 digits only) for ease of use.

1. Dial **3 0** to select this option.

Hear a DOUBLE beep.

2. Enter the Password you wish to use (up to 6 digits). If the password has fewer than 6 digits, enter the # to terminate the string.

If you already have entered a password and want to remove it (to have NO password), just enter the # alone.

Hear TRIPLE beeps.

3. To verify that the new Connect password has been established, dial **3 1** and repeat step 2 above.

For example, 123456 is a valid password entry. 123# is also a valid password entry, resulting in the password 123.

5

Set Programming Password

NOTE: Your Connect and Programming passwords should not be the same. If this feature is active and the system has been accessed via the telephone interface, then after the first digit of your Programming password is pressed, the dial tone will stop and will not be returned until the correct password is entered or until the user hangs up and re-enters the system.

For example, 234567 is a valid password entry. 234# is also a valid password entry, resulting in the password 234.

Establishing a Programming password will restrict access to the programming mode of the PagePac Plus paging system. It is recommended that access to programming be restricted to the System Administrator, Telecommunications Manager, or other selected users.

This feature will become active once any programming password has been entered via the programming mode. You are not required to establish such a password. The factory-set default programming password is ★ ★

1. Dial **3 2** to select this option.

Hear a DOUBLE beep.

2. Enter the Password you wish to use (up to 6 digits). If the password has fewer than 6 digits, enter the **#** to terminate the string.

If you already have entered a password and now want to remove it (to have NO password), just enter the **#** alone.

Hear TRIPLE beeps.

3. To verify that the new Programming password has been established, dials **3 3** and repeat step 2 above.

Forgot the Password? *In the event that either or both the connect password and programming password are forgotten, it will be necessary to call the Help line (refer to page 2) for instructions how to erase the two passwords and be able to enter new ones.*

6

Turn Confirmation Tone ON/OFF

When the option is ON, a tone will be sent to the telephone interface after a zone has been selected and before a page can be made. The default setting is ON.

1. Dial **4 0** to select this option.

Hear a DOUBLE beep.

2. Dial **0** to turn OFF, or **1** to turn ON.

Hear TRIPLE beeps.

3. To verify the Confirmation Tone condition (OFF or ON), dial **4 1** and repeat step 2 above.

7 Turn Pre-Announcement Tone ON/OFF

This tone is very similar to the initial talk-back warning tone, in the sense that it is sent to a zone when the zone is accessed. This tone will be sent out to both the zone selected and to the telephone interface. After this tone is sent, you may begin your page message. Default is ON.

1. Dial **4 2** to select this option.
Hear a DOUBLE beep.
2. Dial **0** to turn OFF, or **1** to turn ON.
Hear TRIPLE beeps.
3. To verify the condition (OFF or ON) of the Pre-Announcement tone, dial **4 3** and repeat step 2 above.

8 Set Talk-Back Warning Tone

This tone is intended to alert a person that their conversation is being monitored through the paging system loudspeaker. If Talk-back is optioned for YES, then the choices will be Initial, 30 Second Repetition, or Off. The default setting for this parameter is Initial and 30 Second Repetition.

1. Dial **4 4** to select this option.
Hear a DOUBLE beep.
2. Dial **0** to turn OFF, **1** to select INITIAL tone only, or **2** to select Initial and 30 Second repeat.
Hear TRIPLE beeps.
3. To verify the condition of the Talk-Back Warning tone, dial **4 5** and repeat step 2 above.

9 Set VOX Disconnect Timing

The system will hang up on a page if no audio is detected for the programmed amount of time. The default time is 30 seconds, but can be varied from 10 seconds to 60 seconds, in 10 second increments, or can be disabled completely.

1. Dial **5 0** to select this option.
Hear a DOUBLE beep.
Continued on next page...

-
2. Dial the code to select a duration for the VOX Disconnect Timing:

0 to turn OFF

1 to select 10 seconds 4 to select 40 seconds

2 to select 20 seconds 5 to select 50 seconds

3 to select 30 seconds 6 to select 60 seconds

Hear TRIPLE beeps.

3. To verify the duration of the VOX Disconnect Timing, dial **5 1** and repeat step 2 above.

10

Enable Computer Monitor

This option selects a device to be connected to the Controller RS-232 port, a computer monitor for logging of all paging activity or a visual message display. The default setting is Computer Monitor.

By selecting **Computer Monitor** (the default option), the system is enabled to monitor activity on Attendant Access, Telephone Interface, and Night Bell inputs. This feature requires that a PC computer be connected to the RS-232 port of the Controller. Whenever the input becomes active, ASCII characters will be sent out the RS-232 port (DB9 pin connector) to the computer. The ASCII characters will be intercepted by a special software package in the computer that logs the time, date, input zone, type of activity, zone that was paged, and duration of the activity. All such input activity to the paging system can then be viewed (and recorded) on the computer.

By selecting **Display**, the monitoring activity described above enables commands to be sent to a visual message display where preprogrammed messages are displayed.

1. Dial **5 2** to select this option.

Hear a DOUBLE beep.

2. Dial the **0** to select Computer Monitor, or **1** to select Visual Display

Hear TRIPLE beeps.

3. To verify the status of this option, dial **5 3** and repeat step 2 above.

If a Computer Monitor or visual message display has been connected and Controller software loaded, you will need to select the types of paging inputs to be displayed or recorded. See next programming option "Input Computer Monitor."

11

Select Input to Computer Monitor

This option turns ON or OFF the inputs of Attendant Access, Telephone Access, and Night Bell to be recorded and displayed by the Computer Monitor if you have activated it in Step 10. Default is OFF for all three.

You will repeat this procedure 3 times in order to reset all three inputs.

1. Dial **5 4** to select this option.

Hear a DOUBLE beep.

2. Dial the code to select an option for one of the three inputs:

- 0** to turn OFF the Attendant Access
- 1** to turn ON the Attendant Access
- 2** to turn OFF the Telephone Access
- 3** to turn ON the Telephone Access
- 4** to turn OFF the Night Bell
- 5** to turn ON the Night Bell

Hear TRIPLE beeps.

3. To verify the status of this option, dial **5 5** and repeat step 2 above.

12

Set Serial Port Bit Rate

The speed (bit rate) of the controller's RS-232 serial port can be set to the rate of the computer monitor or visual display. Default is 9600 bps. The bit rate may be changed at any time, but the Controller must be reset (power off then on again) in order to take effect.

1. Dial **2 2** to select this option

Hear a DOUBLE beep.

2. Dial a code to select the Serial Port Bit Rate

- 0** to select 300 bps **4** to select 9600 bps
- 1** to select 1200 bps **5** to select 14400 bps
- 2** to select 2400 bps **6** to select 19200 bps
- 3** to select 4800 bps

Hear TRIPLE beeps.

3. To verify the status of this option, dial **2 3** and repeat step 2 above.

13 Set Supervised Trunk Mode

If the host telephone system is not a Merlin Legend this feature does not apply. Proceed to Step 14.

NOTE: Once the option has been configured, you should place the Controller Telephone Mode switch to the Ground Start position. Connect the telephone interface to a Loop Start trunk on the host system using a standard two-conductor (not four-conductor) RJ-11 cable.

NOTE: The Ground Start and Station Access modes are not available when the Controller is configured for Supervised Trunk mode. Supervised Trunk mode must be turned off to re-enable these access modes.

The Supervised Trunk access mode provides both VOX Disconnect and Forced Disconnect timeouts. When the Controller detects that the it has been off hook for two minutes, it opens the trunk circuit for one second, ending the call. Also, if no voice activity is detected for the period specified by the VOX Disconnect programming option (normally 30 seconds), or if the telephone is overridden by a higher priority activity (i.e., attendant access), the call is disconnected.

1. Dial **5 6** to select this option
Hear a DOUBLE beep.
2. Press **0** to turn OFF, or **1** to turn ON
Hear TRIPLE beeps.
3. To verify the condition (ON/OFF) of the Supervised Trunk mode, dial **5 7** and repeat step 2 above.

14 Specify Zone Microphone

This option allows you to specify that a zone microphone is attached to the Attendant Access interface. When the Zone Microphone option is enabled (ON), the controller will wait for a zone to be selected from the microphone keypad before it makes a page. When disabled (OFF), the controller reverts to its normal (All Call) operation.

1. Dial **5 8** to select this option
Hear a DOUBLE beep.
2. Dial **0** to turn OFF, or **1** to turn ON
Hear TRIPLE beeps.
3. To verify the condition (OFF/ON) of the Zone Microphone option, dial **5 9** and repeat step 2 above.

15 Inhibit Dial Tone Detect

Supervision of the Station/Centrex Access mode is accomplished in 3 ways, by monitoring the loop current and the audio signal (including dial tone), and a forced disconnect timer. This option (only applicable in the station access mode) enables you to defeat the dial tone detect function in order to send a tone via the Telephone Interface to the output.

1. Dial **2 4** to select this option
Hear a DOUBLE beep.
2. Dial **0** to turn Enable, or **1** to turn Inhibit
Hear TRIPLE beeps.
3. To verify the condition (OFF/ON) of the Dial Tone Detect option, dial **2 5** and repeat step 2 above.

General Zone and Zone Group Configurations

General Zone and Zone Group Configurations are options that apply to selected zones or groups, not to the entire system. The steps following "Copy Command," describe each option.

COPY Command

The COPY command can be used to copy the configuration of a zone that has already been optioned, to one or more additional zones. This saves re-entering the same parameters over again, to duplicate the parameters of an existing zone.

1. Dial **1 2** to activate COPY command.
Hear a DOUBLE beep tone.
2. Enter the zone number that you wish to copy from (i.e., 01).
Hear DOUBLE beep tone.
3. Enter the zone number of the beginning of the range of zones you wish to copy to.
Hear a DOUBLE beep tone.
4. Enter the zone number of the END of the zone range to be copied to.
Hear a TRIPLE beep tone.

NOTE: Program the Controller using the physical zone number.

For example, to copy the parameters of zone 01 to *all* other zones, the range zone 02 to 56 would be entered in this step and the next. To copy to a single zone (for example, 02) enter that zone number as both the beginning and the end of the range (02 to 02). In this step, enter only the beginning zone of the zone range.

16 Zone Map Option—Assigning ALIAS Numbers

NOTE: Before doing this option, you MUST do “Define Length of ALIAS Numbers” (see Step 3).

Zone Map permits you to assign the dialing code, called the ALIAS zone code, that you will dial to access a particular zone by telephone (i.e., instead of dialing 02 to make a page, you could dial 2202). The factory default is NONE: no ALIAS numbers are pre-programmed. The zones are identified by their 2-digit Physical Zone Codes (01 thru 56 and groups 81-88) as the default condition.

Digit string length for an ALIAS code can be 3 or 4 digits, but all ALIAS codes must have the same number of digits. (Refer to Step 3) The ★ and # digits are not applicable digits for zone ALIAS numbers.

NOTE: If ALIAS numbers are enabled, you MUST use them for programming from now on.

Refer to your own Zone Map and the Example Zone Map at the end of this programming section.

When an ALIAS number for a zone is changed, all the previous zone options for that zone will be transferred to the new zone number.

1. Dial **6 0** to select this option.

Hear a DOUBLE beep.

2. Enter the 2-digit PHYSICAL zone/group code, of the zone to be given an ALIAS number.

Hear a DOUBLE beep.

3. Enter the ALIAS zone/group number you have chosen.

Hear TRIPLE beeps.

4. To verify the assignment of an ALIAS to a selected zone or group, dial **6 1** and repeat steps 2 and 3 above.

17 Type of Zone: Input or Output

NOTE: The INPUT #1 option must only be assigned to physical zones 1 through 8 (on the Controller).

The choices here are INPUT #1, INPUT #2, and OUTPUT. Be sure the manually selectable Zone Option switch on the rear of the Controller or Zone Expansion Unit is set to match the type of zone selected (input or output). Input #1 would be used for an emergency alert, say a connection to your alarm system. Input #2 would be a lower priority, say a doorbell input.

The factory default is OUTPUT (i.e., all zones are output type, by default).

1. Dial **6 2** to select this option.

Hear a DOUBLE beep.

2. Enter the number of the zone or zone group to be optioned. Use ALIAS numbers, if optioned. Otherwise, use Physical zone/group numbers.

Hear a DOUBLE beep.

Continued on next page...

-
3. Press **0** to designate the zone as OUTPUT
Press **1** to designate it as INPUT #1, or
Press **2** to designate it as INPUT #2
Hear TRIPLE beeps.
 4. To verify the zone type assignment, dial **6 3** and repeat steps 2 and 3 above.

18 Set Input Priority Arrangement

The input priorities are pre-set at the factory. You may only assign a priority level to inputs such as doorbell or security alarm, by assigning them to Input #1 or Input #2, which differ in priority.

The default setting is:

- 1 – Attendant Access
- 2 – Input #1
- 3 – Telephone Access
- 4 – Input #2
- 5 – Night Bell
- Music (always lowest priority)

NOTE: These priorities cannot be rearranged. Also, if you select more than one zone to be inputs of the same level (Input 1, for example), such inputs will be handled on a first in, first served basis. See Type of Zone option, under Zone / Group Configurations programming, later in this section.

19 Set Zone or Group Zone to Remote Monitor

This option selects a zone or group zone for computer monitoring, (logging of paging activity), or for visual message display. The default setting is off (Refer to Step 10).

1. Dial **6 6** to select this option.
Hear a DOUBLE beep.
2. Enter zone or group zone number.
3. Dial the code to activate this option:
 - 0** to select OFF
 - 1** to select ON.*Hear TRIPLE beeps.*
4. To verify the status of this option, dial **6 7** and repeat step 2 above.

20

Set Zone Grouping to Page

This option allows you to select a group of zones to be paged at the same time. The number of zone groups that can be formulated is eight; the maximum number of zones per group is 56 zones.

The factory default is NONE (there are no default zone groups).

You will need to repeat this procedure for each zone group you wish to set up.

1. Dial **6 4** to select this option.

Hear a DOUBLE beep.

2. Enter the zone code, of the zone group to be defined (81 thru 88).

Hear a DOUBLE beep.

3. Enter zone codes of each zone to be included in the group.

Hear a Confirmation Tone for each zone, then dial tone

4. Press **#** to end the string of zones.

Hear TRIPLE beeps.

5. To verify the zone group assignment, dial **6 5** and repeat steps 2 and 3 above.

For example, dial 81 for zone group 81 (Zone group 80 is always All Call). Use ALIAS numbers, if optioned. Otherwise, use Physical zone/group numbers.

For example, 01 (tone), 02 (tone), 13 (tone), 14 (tone), #, indicates zones 1, 2, 13, and 14 are included in this group. Enter the codes consecutively, with no digit or character between them. Use ALIAS numbers, if optioned. Otherwise, use Physical zone/group numbers.

Output Zone/Group Configurations

These options apply to zones or groups already configured as outputs (see Step 17, "Type of Zone,"). All these parameters can be individually optioned per zone. For a summary of these options, see the Programming Quick Reference Chart at the end of this section.

Continued on next page...

21 Set Output Zone Type

This option selects the type of output for an individual output zone. The choices here are Audio/Normally Open, Normally Closed, System Handshake, Momentary Open, Toggle, Phantom, and Attendant Access Handshake. The Audio/Normally Open option is the default. The primary use for the Normally Closed Or System Handshake is to determine how the switch closure is to function.

NOTE: System Handshake is a feature required by certain PBX systems: when they access the paging system, they require a return acknowledgment signal – the “handshake” – from the Controller.

When the System Handshake option is chosen, the closure will energize when a valid Off Hook condition has been detected. The *Attendant Access Handshake* zone provides an output contact closure when Attendant Access interface is ready to make a page.

A *Phantom Zone* is an output zone that exists only in software. If a page is made to a Phantom zone, the controller will send a message to an attached monitoring device (if configured) and will issue confirmation tone, but will take no action with respect to the zone’s hardware. This allows uninstalled zones to be used to select messages on a visual display.

The Momentary Open and Toggle options are intended to be used for controlling door striker plates, for instance, to permit a security door to be unlocked. The Momentary Open will stay energized for as long as the zone is selected. The Toggle will stay energized until the zone is selected again. Neither of these modes will respond to an Attendant Access page or an All-Call page. Repeat this procedure for each output zone.

1. Dial **7 0** to select this option.

Hear a DOUBLE beep.

2. Enter the output zone number.

Hear a DOUBLE beep.

3. Enter the code for the type of output you wish to select:

- 0** selects AUDIO/N.O. (Normally Open)
- 1** selects Momentary Open
- 2** selects N/C (Normally Closed)
- 3** selects Sys HS (System Handshake)
- 4** selects Toggle
- 5** selects Phantom
- 6** selects AA Ready (Attendant Access Handshake)

Hear TRIPLE beeps.

4. To verify the Type of Output assignment, dial **7 1** and repeat steps 2 and 3 above.

Use Alias numbers, if optioned. Otherwise, use Physical zone/group numbers.

22 Set Page Enable

NOTE: If you make an all-call page and this option is selected NO in either a Zone Group or Individual Zones, then an all-call page will be made to all other zones except the ones specified. If the decision is NO for the All-Call zone and an all-call page is made, then an error tone will be returned to you.

NOTE: Use ALIAS numbers, if optioned. Otherwise, use Physical zone/group numbers.

This output zone parameter enables paging for a selected output zone or zone group. The choice for this selection is YES/NO, with the default being YES. Repeat this procedure for each output zone or zone group.

1. Dial **7 4** to select this option.
Hear a DOUBLE beep.
2. Enter the zone number, of the zone or group you wish to configure.
Hear a DOUBLE beep.
3. Enter **0** for NO (Page Not Enabled) or **1** for YES (Page enabled)
Hear TRIPLE beeps.
4. To verify the status of Page Enable for a given zone, dial **7 3** and repeat steps 2 and 3 above.

23 Set Music Enable if Background Music is Used

This is an individual zone output parameter, that enables background music to be broadcast to a selected output zone (in the absence of a higher priority paging output). The choice is YES/NO, with the default being NO. Repeat this procedure for each output zone that you wish to have background music.

1. Dial **7 4** to select this option.
Hear a DOUBLE beep.
2. Enter the zone or group zone number.
Hear a DOUBLE beep.
3. Enter **0** for NO (Music Not Enabled) or **1** for YES (Music enabled)
Hear TRIPLE beeps.
4. To verify the status of Music Enable for a given zone, dial **7 5** and repeat steps 2 and 3 above.

24 Set Talkback Enable

This is a zone output parameter that enables talkback capability for a selected output zone or group. The choice is YES/NO, with the default being set to NO.

All speakers in a zone or group will be active 2-way speakers if talkback has been enabled for a zone. Repeat this procedure for each output zone or zone group that you wish to have talk-back.

NOTE: Refer to the Applications notes on Talkback, page 62.

NOTE: Use ALIAS numbers, if optioned. Otherwise, use Physical zone/group numbers.

1. Dial **7 6** to select this option.
Hear a DOUBLE beep.
2. Enter the zone or group zone number.
Hear a DOUBLE beep.
3. Enter **0** for NO (Not Enabled) or **1** for YES (Enabled)
Hear TRIPLE beeps.
4. To verify the status of Talk-Back Enable for a given zone, dial and repeat steps 2 and 3 above.

25 Set Night Bell Enable

This is an individual zone output parameter. The choice is YES/NO with the default being NO. With this parameter set to YES, night bell will be sent to selected outputs whenever ring voltage is present on the night bell input (from the PBX to the controller).

If a closure is required to trigger the night bell, then a zone will need to be configured as an input to send night bell to designated zones when a closure is present. This is discussed in Steps 27 and 28, Tone Selection and Tone Routing.

You will need to repeat this procedure for each output zone that you wish to receive the night bell signal.

1. Dial **7 8** to select this option.
Hear a DOUBLE beep.
2. Enter the zone or group zone number.
Hear a DOUBLE beep.
3. Enter **0** for NO (Not Enabled) or enter **1** for YES (Enabled)
Hear TRIPLE beeps.
4. To verify the status of Night Bell Enable for a given zone, dial **7 9** and repeat steps 2 and 3 above.

NOTE: Use ALIAS numbers, if optioned. Otherwise, use Physical zone/group numbers.

26 Pass DTMF to the Output

This zone output option enables the Touchtone telephone keypad tones (DTMF) to be passed through the Controller and output to a second controller or other ancillary device.

The choice is YES/NO, with the default being NO. Operating the unit in the default mode, you may switch from zone to zone (within the same Controller) without hanging up, simply by dialing the zone number of the zone you wish to switch to. The DTMF tones you dial will be muted (not sent out as audio) as soon as they are detected by the controller.

Access to the first zone will be disconnected and you will hear a pre-announcement tone when the zone switch has been accomplished (if pre-announcement tone has been enabled).

When you have accessed a zone with this parameter set to YES, DTMF will be sent out as un-muted audio but the Controller will not respond to the DTMF tones (and will not switch zones).

This YES option, with DTMF tones enabled to the output, is useful when you have more than one Controller daisy-chained in a system. The un-muted DTMF tone is passed through the first controller (not triggering a zone change) to the second controller (or other ancillary device), where it DOES activate a zone.

You will need to repeat this procedure for each output zone or zone group that you wish to receive the DTMF tones.

1. Dial **9 0** to select this option.

Hear a DOUBLE beep.

2. Enter the zone or group zone number.

Hear a DOUBLE beep.

3. Enter **0** for NO (Not pass DTMF) or enter **1** for YES (Pass DTMF)

Hear TRIPLE beeps.

4. To verify the status of DTMF Pass for a given zone, dial **9 1** and repeat steps 2 and 3 above.

NOTE: If you leave NO in option mode, you may page zone to zone without exiting system. System is locked up while you roam zone to zone.

NOTE: If you access a zone that is enabled for passing DTMF, you will not be able to switch to another zone (on the same controller) except by hanging up and re-initializing access to the PagePac Plus system.

NOTE: Use ALIAS numbers, if optioned. Otherwise, use Physical zone/group numbers.

Input Zone / Group Options

These options apply to zones or groups already configured as inputs (see “Type of Zone,” Step 17). These options are summarized in the Programming Quick Reference Chart, at the end of this section.

27 Tone Selection

If a zone is configured to be an input and is activated, then a tone may be selected to be directed to whatever zone(s) are selected in “Tone Routing,” below. The tone selections are listed in step 3.

For example, you wish to have a doorbell pushbutton input cause a chime to be heard in certain zones. You have already configured the zone of the doorbell as an input zone. You need to select the tone (chime) you wish to be heard in the output zones, when the doorbell is pressed. This is called “Activate Tone via an Input Closure,” on the Quick Reference Chart.

The default setting for this option is NONE (not activated).

1. Dial **9 2** to select this mode option.

Hear a DOUBLE beep.

2. Enter the number of the input zone (i.e., the zone containing the doorbell pushbutton). Use ALIAS numbers, if optioned. Otherwise, use Physical zone/group numbers.

Hear a DOUBLE beep.

3. Enter the tone option, **0** through **7**.

- 0** None
- 1** Chime
- 2** Siren
- 3** Warble Siren
- 4** Night Bell
- 5** Fast Ring
- 6** Steady Tone
- 7** Door Bell

Hear TRIPLE beeps.

4. To verify the tone option for a given input zone, dial **9 3** and repeat steps 2 and 3 above.

Continued on next page...

Description of Tones

Dial tone: continuous, like the dial tone of a telephone system
Confirmation tone: three beeps
Pre-Announcement tone: 1.5 second duration, 440 Hz
Talk-back Warning tone: 1.5 second duration, 440 Hz
Programming Ready tone: similar to dial tone
Programming/Access Confirmation tone: two beeps
Programming/Access Error tone: beep-hoop, beep-hoop, repeating
Override tone: similar to a “busy signal” on a telephone
Night Bell tone: fast ding-a-ling
Chime: constant period with a sweeping duty cycle
Warble Siren: sweep frequencies up and down
Fast Ring: fast electronic ringer
Steady Tone: steady tone
Door Bell: ding-dong

28 Set Tone Routing

Whatever zones are selected here will receive the tone selected in the previous option, “Tone Selection.”

For example, you have optioned an input zone to receive a doorbell pushbutton input. And you have selected a tone (in the previous step) to be output when the doorbell input is received. Now you must select the output zone or zone group which will receive the tone.

NOTE: Use ALIAS numbers, if optioned. Otherwise, use Physical zone/group numbers.

1. Dial **9 4** to activate Tone Routing.
Hear a DOUBLE beep.
2. Enter the input zone number.
Hear a DOUBLE beep.
3. Enter the output zone/group ALIAS number.
Hear TRIPLE beeps.
4. To verify Tone Routing, dial **9 5** and repeat steps 2 and 3 above.

29 Audio Source Enable

The primary use for this feature is to allow the paging system to be used for door service. If optioned, whenever a selected zone is active (i.e., the doorbell pushbutton), an audio source (either Telephone Access or Attendant Access) will be routed automatically to a zone (the door speaker-phone) selected in “Audio Routing,” below. The default for this option is NONE.

Continued on next page...

Use ALIAS numbers, if
optioned. Otherwise, use
Physical zone/group numbers.

1. Dial **9 6** to select Audio Source Enable.
Hear a DOUBLE beep.
2. Enter the input zone or group number.
Hear a DOUBLE beep.
3. Enter **0** (NONE), **1** (AA, Attendant Access), or **2** (T/R, Telephone Access) to select the audio source (or none) to be enabled when this zone is activated.
Hear TRIPLE beeps.
4. To verify your selection, Dial **9 7** and repeat steps 2 and 3, above.

30 Set Audio Routing

If optioned, whenever a selected input zone with “Audio Source Enabled” is active, the audio source (either Telephone Access or Attendant Access) will be routed to the selected zone or group. The default for this parameter is NO ZONES.

Door Service

The primary use for this feature is to allow the paging system to be used for door service. For example, you have optioned the doorbell input zone to enable Telephone Access, and you wish now to select the door speaker to be the output zone for this Telephone Access audio.

The audio path will remain routed for 10 seconds. If the user accesses the controller during the 10 second period, they will automatically be routed to the zone specified in this procedure. If the user accesses the controller after the time expires, the user will receive a dial tone.

NOTE: If a Connect password has been installed in your system, you will have to access the paging system and enter your password, before being automatically routed to the zone.

If the doorbell input has a higher priority than the telephone access and is activated while telephone access paging is underway, then you will receive the tone specified in the option “Tone Selection,” above, and then will be automatically routed to the proper zone.

1. Dial **9 8** to select Audio Routing.
Hear DOUBLE beeps.
2. Enter the input zone or group zone number.
Hear DOUBLE beeps.
3. Enter the output zone / group ALIAS number.
Hear TRIPLE beeps.
4. To verify your selection, dial **9 9** and repeat steps 2 and 3 above.

Error Tones

The Error Tone is heard over the phone receiver when an incorrect zone number has been dialed or contradictory programming input has been attempted.

Hear error tone when dialing a zone ALIAS number

When a zone is selected by Touchtone telephone keypad input (DTMF), the PagePac Plus searches for the zone in numerical order of the physical zones; the value dialed (the ALIAS number) is then compared to the digits stored in memory for each physical zone. If not found, then an error tone will be returned to the user. Refer to your Zone Map to review your ALIAS number assignments, and review of the Zone Map Option programming steps.

Error tone received when programming a zone or group

If ever there is a conflict in the programming options between a zone and a group to which it is assigned (i.e., zone 1 is optioned as an input as an individual zone, but is optioned as an audio output as part of a zone group), then an error tone will be returned to the user's receiver.

Zone group configurations will override individual zone configurations whenever a zone group is selected. Refer to your filled-in Zone Map and Zone Configuration Tables to identify any conflict, and reprogram the erroneous zone.

Programming Quick Reference Chart

Chart 1. System Configuration Options

Feature	Mode Option/ Verify	Dial	Listen For	Choose Option	Listen For	Default
Reset to Factory Defaults	To Select	10	Double Beep	Enter 25327 to reset. Enter any invalid number string to escape.	Triple Beeps	25327 (CLEAR)
Number of Zone Map Digits	To Select To Verify	20 21	Double Beep	3 (digits) 4 (digits)	Triple Beeps	2
Connect Password	To Select To Verify	30 31	Double Beep	Enter Password, enter # to terminate the string.	Triple Beeps	None
Programming Password	To Select To Verify	32 33	Double Beep	Enter Password, enter # to terminate the string.	Triple Beeps	**
Confirmation Tone	To Select To Verify	40 41	Double Beep	0 – Off 1 – On	Triple Beeps	On
Pre-Announcement Tone	To Select To Verify	42 43	Double Beep	0 – Off 1 – On	Triple Beeps	On
Talk-back Warning Tones	To Select To Verify	44 45	Double Beep	0 – Off 1 – Initial 2 – Initial and 30 sec.	Triple Beeps	Initial and 30 sec.
VOX Timer Disconnect	To Select To Verify	50 51	Double Beep	Enter Duration 0 – Off 1 – 10 sec. 2 – 20 sec. 3 – 30 sec. 4 – 40 sec. 5 – 50 sec. 6 – 60 sec.	Triple Beeps	30 Sec.
Computer Monitor	To Select To Verify	52 53	Double Beep	0 – Computer Monitor 1 – Visual Display	Triple Beeps	Computer Monitor
Input Computer Monitor	To Select To Verify	54 55	Double Beep	0 – AA Off 1 – AA On 2 – T/R Off 3 – T/R On 4 – N.B. Off 5 – N.B. On	Triple Beeps	AA – Off T/R – Off N.B. – Off
Serial Port Bit Rate	To Select To Verify	22 23	Double Beep	0 – 300 bps 1 – 1200 bps 2 – 2400 bps 3 – 4800 bps 4 – 9600 bps 5 – 14400 bps 6 – 19200 bps	Triple Beeps	9600 bps
Supervised Trunk Mode	To Select To Verify	56 57	Double Beep	0 – Off 1 – On	Triple Beeps	Off
Zone Microphone	To Select To Verify	58 59	Double Beep	0 – Off 1 – On	Triple Beeps	Off
Dial Tone Detect	To Select To Verify	24 25	Double Beep	0 – Enable 1 – Inhibit	Triple Beeps	Enable

***NOTES:**

Exit the programming mode by dialing #. The # key will terminate a digit string (i.e., Password string)

Chart 2. General Zone / Group Configurations

Feature	Mode Option/ Verify	Dial	Listen For	Zone/Group Selection	Listen For	Choose Option	Listen For	Default
Zone Map	To Select To Verify	60 61	Double Beep	Enter physical zone/group number.	Double Beep	Enter alias zone/group number.	Triple Beeps	None
Type of Zone	To Select To Verify	62 63	Double Beep	Enter zone/group number.	Double Beep	0 – Output 1 – Input 1 2 – Input 2	Triple Beeps	Output
Zone Grouping	To Select To Verify	64 65	Double Beep	Enter group number.	Double Beep	Enter zone numbers. A # will terminate the string.	Triple Beeps	None
Remote Monitor	To Select To Verify	66 67	Double Beep	Enter zone or group number (Z)	Double Beep	0 – OFF 1 – ON	Triple Beeps	OFF

NOTES:

When a Zone map number (ALIAS) is changed, all of the previous options for that zone will be transferred to the new zone number.

Program the Controller using ALIAS numbers, if optioned. Otherwise, use the physical zone/group numbers.

Exit the programming mode by dialing #

The # key will terminate a digit string (i.e., Zone Numbers string)

Chart 3. Output Zone / Group Configurations

Feature	Mode Option/ Verify	Dial	Listen For	Zone/Group Selection	Listen For	Choose Option	Listen For	Default
Type of Output	To Select To Verify	70 71	Double Beep	(Z)	Double Beep	0 – Audio/N.O. 1 – Mom. Open 2 – N/C 3 – Sys HS 4 – Toggle 5 – Phantom 6 – AA Ready	Triple Beeps	Audio/ N.O
Page Enable	To Select To Verify	72 73	Double Beep	(Z,G)	Double Beep	0 – No 1 – Yes	Triple Beeps	Yes
Music Enable	To Select To Verify	74 75	Double Beep	(Z)	Double Beep	0 – No 1 – Yes	Triple Beeps	No
Talk-Back Enable	To Select To Verify	76 77	Double Beep	(Z,G)	Double Beep	0 – No 1 – Yes	Triple Beeps	No
Night-Bell Enable	To Select To Verify	78 79	Double Beep	(Z)	Double Beep	0 – No 1 – Yes	Triple Beeps	No
Pass DTMF to the Output	To Select To Verify	90 91	Double Beep	(Z,G)	Double Beep	0 – No 1 – Yes	Triple Beeps	No

Chart 4. Input Zone / Group Configurations

Feature	Modify Option/ Verify	Dial	Listen For	Zone/Group Selection	Listen For	Choose Option	Listen For	Default
Activate Tone via an Input Closure	To Select To Verify	92 93	Double Beep	Enter the input zone number.	Double Beep	0 – None 1 – Chime 2 – Siren 3 – Warble Siren 4 – Night Bell 5 – Fast Ring 6 – Steady Tone 7 – Door Bell	Triple Beeps	<i>None</i>
Tone Routing	To Select To Verify	94 95	Double Beep	Enter the input zone number.	Double Beep	Output zone/group number	Triple Beeps	<i>None</i>
Audio Source Enabled	To Select To Verify	96 97	Double Beep	Enter the input zone number.	Double Beep	0 – None 1 – AA 2 – T/R	Triple Beeps	<i>None</i>
Audio Routing	To Select To Verify	98 99	Double Beep	Enter the input zone number.	Double Beep	Output zone/group number	Triple Beeps	<i>None</i>

***NOTES:**

Program the PagePac Plus using the ALIAS numbers, if optioned. Otherwise, use Physical zone/group numbers

Exit the programming mode by dialing **#**

The # key will terminate a digit string (i.e. Zone Numbers string)

The Copy Command

Copy Command	Dial 12	Double Beeps	Enter zone number that is to be copied.	Double Beeps	Enter the beginning of the range.	Double Beeps	Enter end of the range.	Triple Beeps
-----------------	---------	-----------------	---	-----------------	---	-----------------	----------------------------	-----------------

Zone Map and Zone Configuration Tables

The Zone Map (table 7) assists in identifying each zone, both input and output, of your particular paging layout. The Zone Configuration table (table 8) identifies each input and output zone, and their associated features. Refer to your facilities floor plan. With these three tables filled out, programming can begin.

NOTE: You may find it helpful to photocopy the tables and fill the copies out.

Follow steps 1 thru 3 and fill out the Zone Map tables on the next page, and steps 4 to 11 and fill out the Zone Configuration (Output and Input Zones) tables. When completed, proceed to page 29 and begin programming the system.

1 Write a brief description of each zone.

For example, Lobby, Warehouse, Doorbell: Security Door, Fire alarm, etc.

2 Assign ALIAS Zone Numbers (optional).

An Alias Zone Number is the extension number (3 or 4 digits) you intend to dial to reach this zone. If an ALIAS number is assigned to any zone, ALIAS numbers must be assigned to ALL zones.

3 Enter the Input or Output zone type.

Write an I-1, I-2, or an O to indicate the type of zone. I-1 means input priority level 1; I-2 means input priority 2 (the higher the priority zones get first access to the Controller). Input and Output here mean inputs to, or outputs from, the Controller.

4 Fill in description of Output Zone.

See examples in step one. Refer to the Zone Map

5 Enter the Type of Output

The options are Audio/N.O., Mom. Open, N-C, Sys HS, Toggle, Phantom, or AA Ready.

6 For the other features listed for that zone, enter a Y (yes) or N (no) to implement those options.

7 Fill in description of Input Zone.

See examples in step one. Refer to the Zone Map

Continued on next page...

8 Enter the Priority Level (1 or 2) for this zone

Priority Level 1 inputs are “first in” to access the page

9 Select Tone 1 - 7 for this zone

See Tone Selection descriptions on page 44.

10 Enter the Zone or Group Zone to receive the tone.

Refer to Zone map to determine what zones will hear this tone.

11 Enter 0, 1, or 2 for Audio Enable to this zone.

0 = None, 1 = AA, Attendant Access, and 2 = T/R Telephone Access. Refer to Audio Enable on page 46.

12 Enter the zone number to route the audio to.

Refer to Step 30 on page 47 for an explanation of this feature.

13 Upon completion of the Zone Map and Zone Configuration Tables, go to page 29 to begin programming.

Table 7. Zone Map

DESCRIPTION OF ZONE	PHYSICAL ZONE NUMBER	PHYSICAL ZONE CODE	ALIAS* ZONE NUMBER	INPUT (1 OR 2) OR OUTPUT
	Zone 1	01		
	Zone 2	02		
	Zone 3	03		
	Zone 4	04		
	Zone 5	05		
	Zone 6	06		
	Zone 7	07		
	Zone 8	08		
	All Call	80		
	Group 1	81		
	Group 2	82		
	Group 3	83		
	Group 4	84		
	Group 5	85		
	Group 6	86		
	Group 7	87		
	Group 8	88		
Zones 9 thru 24 are located on the First Zone Expansion Unit				
	Zone 9	09		
	Zone 10	10		
	Zone 11	11		
	Zone 12	12		
	Zone 13	13		
	Zone 14	14		
	Zone 15	15		
	Zone 16	16		
	Zone 17	17		
	Zone 18	18		
	Zone 19	19		
	Zone 20	20		
	Zone 21	21		
	Zone 22	22		
	Zone 23	23		
	Zone 24	24		

Table 7. Zone Map (Continued)

DESCRIPTION OF ZONE	PHYSICAL ZONE NUMBER	PHYSICAL ZONE CODE	ALIAS* ZONE NUMBER	INPUT (1 OR 2) OR OUTPUT
	Zone 25	25		
	Zone 26	26		
	Zone 27	27		
	Zone 28	28		
	Zone 29	29		
	Zone 30	30		
	Zone 31	31		
	Zone 32	32		
	Zone 33	33		
	Zone 34	34		
	Zone 35	35		
	Zone 36	36		
	Zone 37	37		
	Zone 38	38		
	Zone 39	39		
	Zone 40	40		
Zones 25 thru 40 are located on the Second Zone Expansion Unit				
	Zone 41	41		
	Zone 42	42		
	Zone 43	43		
	Zone 44	44		
	Zone 45	45		
	Zone 46	46		
	Zone 47	47		
	Zone 48	48		
	Zone 49	49		
	Zone 50	50		
	Zone 51	51		
	Zone 52	52		
	Zone 53	53		
	Zone 54	54		
	Zone 55	55		
	Zone 56	56		
Zones 41 thru 56 are located on the Third Zone Expansion Unit				

Application Notes

Night Bell

There are two different Night Bell connections possible to the Controller. These are illustrated in figure 24.

From an EKTS Telephone System

A programmer needs to know what type of Night Bell connection exists between the telephone system and the Controller. In one case, typically with an EKTS (Key) telephone system, where Night Bell input is wired to one of the eight Controller onboard zones (corresponding to the eight switches on the rear of the controller), then you will need to configure it as an input zone, just as any other (i.e., door bell, alarm system, door ajar). The phone system produces a contact closure.

Required Programming: Type of Zone, step 17, Tone Selection, step 27, and Tone Routing, step 28.

From a PBX or Centrex System

In the other case, typically with a PBX system that produces a ring voltage output, the Night Bell connection is not wired to one of the eight input zones, but to the connector on the rear of the Controller labeled "N.B." (pins 5 and 6, nightbell)

Required Programming: Night Bell Enable, step 25, Tone Selection, step 27, and Tone Routing, step 28.

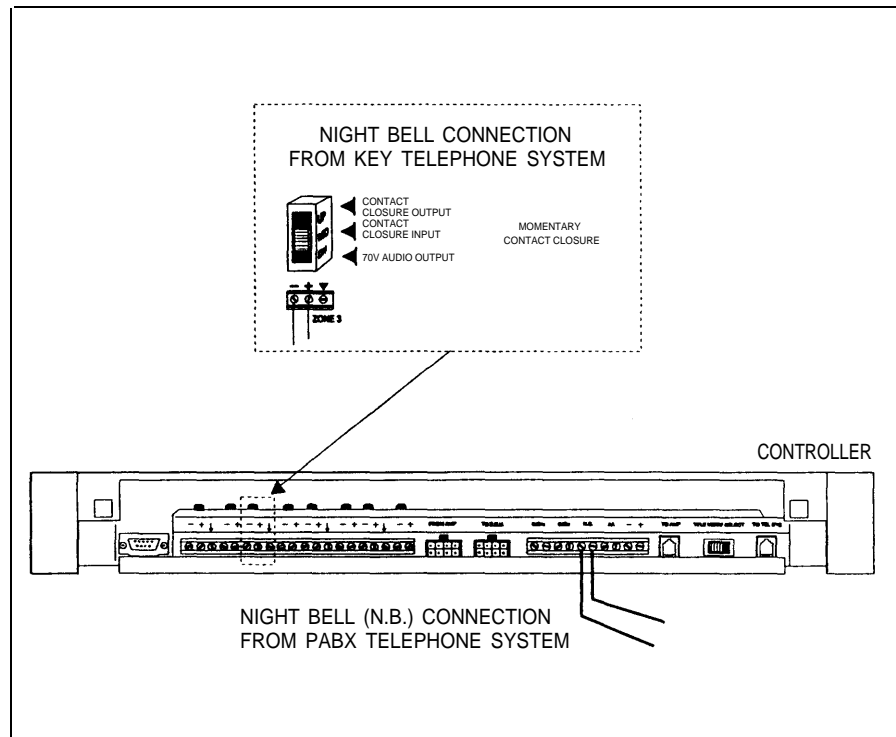

Figure 24. Night Bell Interface

Door and Speaker Control

Visitor Presses Doorbell

Figure 25 illustrates door speaker and control interfaces.

When a visitor presses the doorbell of a security door, a contact-closure input to the controller signals an output tone (i.e., a door chime) to selected paging zone(s).

Required Programming: Type of Zone, step 17 (doorbell as an input zone), Tone Selection, step 27 (select a tone to be sounded when the doorbell input is activated), Tone Routing, step 28 (route the tone to in-facility paging zones), and Audio Enable, step 29 (so that it automatically opens an audio channel between the door speaker and your telephone access (or attendant access)).

Answering the Doorbell

The person inside the building, having heard the door chime, can simply dial the proper extension and establish two-way communications with the door speaker.

If the input zone (door bell) has been optioned for Audio Enable, then the user's telephone access (or attendant access, depending on the option chosen in Audio Enable) connects via the paging system to the door speaker, for a period of 10 seconds. If the user doesn't pick up the phone until after the 10 seconds has passed, he must dial the Door Speaker zone code to talk.

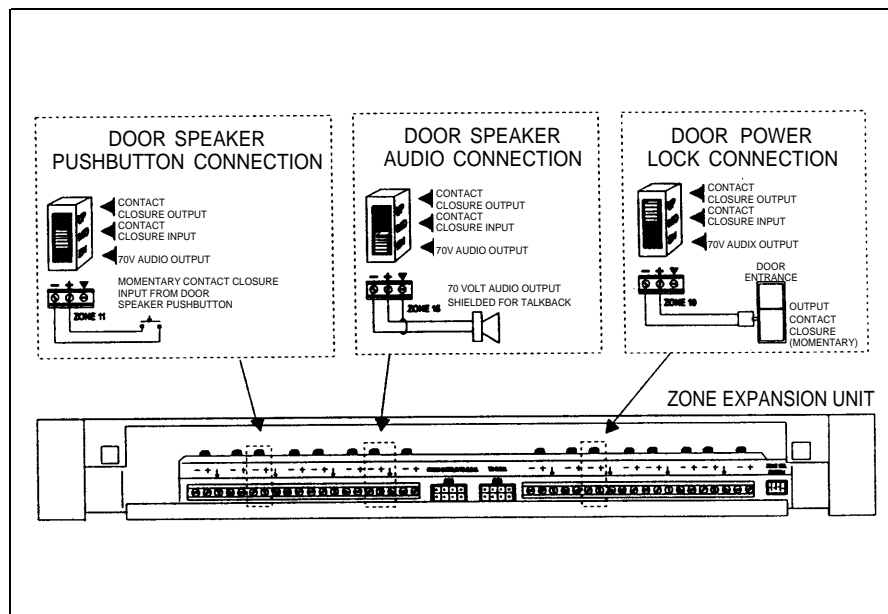

Figure 25. Door Speaker and Control Interfaces

If the doorbell input has a higher priority than T/A (i.e., is Input #1), and is activated while T/A paging is in progress, or during a dial tone, then the user will hear the door chime tone and be automatically routed to the door speaker for two-way communication.

Required Programming: Type of Zone, step 17 (interface the door speaker-phone as an output zone), Output Zone Type, step 21, (configure output for Audio to the door speaker-phone), Page Enable, step 22, (enables page to the door speaker), Talkback Enable, step 24 (enable talk-back for the door speaker), and Audio Routing, step 30 (route the telephone access audio to the door speaker-phone).

Door Unlock

The person inside the building can also remotely unlock the door, by entering a numeric code (Door Code) on the telephone's keypad.

NOTE: The door ajar switch, if any, should be programmed similarly to a doorbell as an input zone, resulting in a tone.

Required Programming: Type of Zone, step 17, (set the door lock device as an output zone), and Output Zone Type, step 21 (momentary, normally-open switch).

Alarm System Input

Figure 26 illustrates a typical alarm system interface. When the alarm system is tripped, a tone will be constantly sent to selected zones until the alarm is reset.

Required Programming: Type of Zone, step 17, (set the alarm system as Input #1, Tone Selection, step 27 (select a tone to be sounded when the alarm input is activated), Tone Routing, step 28 (route the tone to in-facility paging zones).

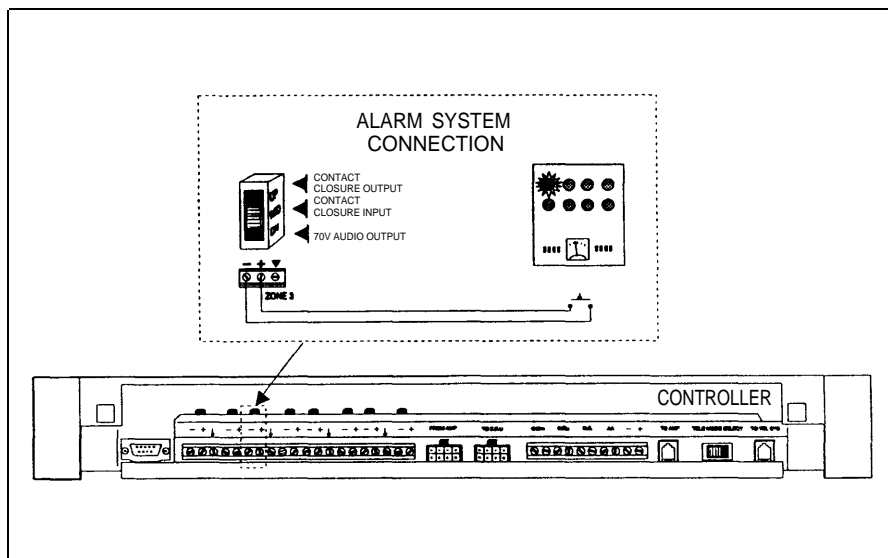

Figure 26. Alarm System Interface

Computer Monitor and Visual Message Display

Figure 27 illustrates the Computer Monitor and Visual Display interface.

If a PC computer is connected to the RS-232 port of the Controller for the purpose of logging paging activities, you will need to program the Controller to send signals to it, and turn ON/OFF the Attendant Access, Telephone Access, and Night Bell signals that would trigger the monitor to log the event.

To communicate with a visual display, you will need to set the Computer Monitor option to Visual Display, and enable the Input Monitor and Remote Monitor options for the interfaces, zones, and zone groups you wish to monitor. You can also use the Phantom option of the Zone Output type parameter.

In addition, you will need to program the visual display with the messages you wish to display.

Required Programming: Computer Monitor, step 10 (set to Computer Monitor or Visual Display), Input to Computer Monitor, step 11 (select monitor types).

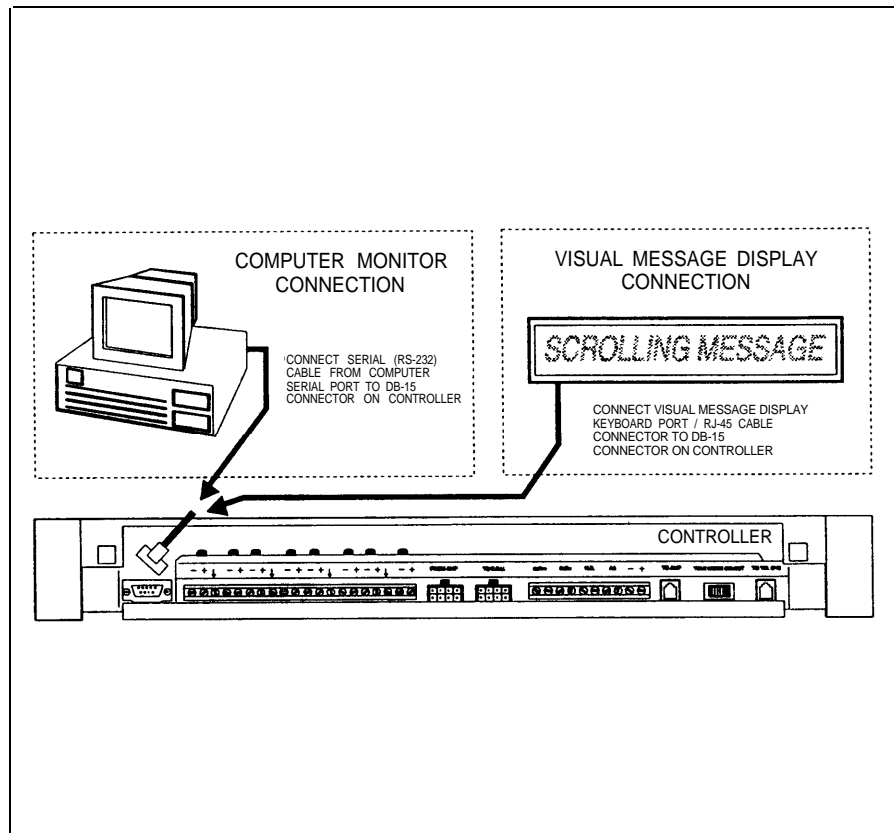

Figure 27. Computer Monitor and Visual Message Display Interface.

Talkback

Any audio output zone can be programmed for Talkback. Each Talkback paging zone *must* use shielded cable, grounded at the Controller zone connector, *not* the speaker. All speakers in a zone will be two-way speakers, if talkback has been enabled for a zone. Therefore all speakers in the talkback zone will pick up ambient noise, as well as the voices of persons addressing the paging speakers. For that reason, it is not recommended to have more than *two* speakers in a zone that is designated for talkback. There should be low ambient background noise levels of 72 dB or less for efficient operation.

Required Programming: Type of Zone, step 17 (set to Output), Talkback Enable, step 24 (activates two-way speakers).

Connecting Additional Controllers or Remote Amplifiers

Figure 28 illustrates the additional Controller and Remote AmpliCenter interface.

When additional Controller(s) or other ancillary devices are daisy-chained with the first Controller, you will want to ensure that the programming option DTMF Enabled to the Output has been selected for a YES condition for output zones. This permits you, when engaged in paging by telephone in one zone, to dial another zone number (residing on the remote Controller unit) and automatically reach that zone. Your DTMF dial input tones are passed through the first (main) Controller, to the second one, where a switch of zones occurs in response to the dialed tones.

Required Programming: Type of Zone, step 17 (contact closure output to remote Controller), Enable DTMF to output, step 25 (send tone to remote Controller).

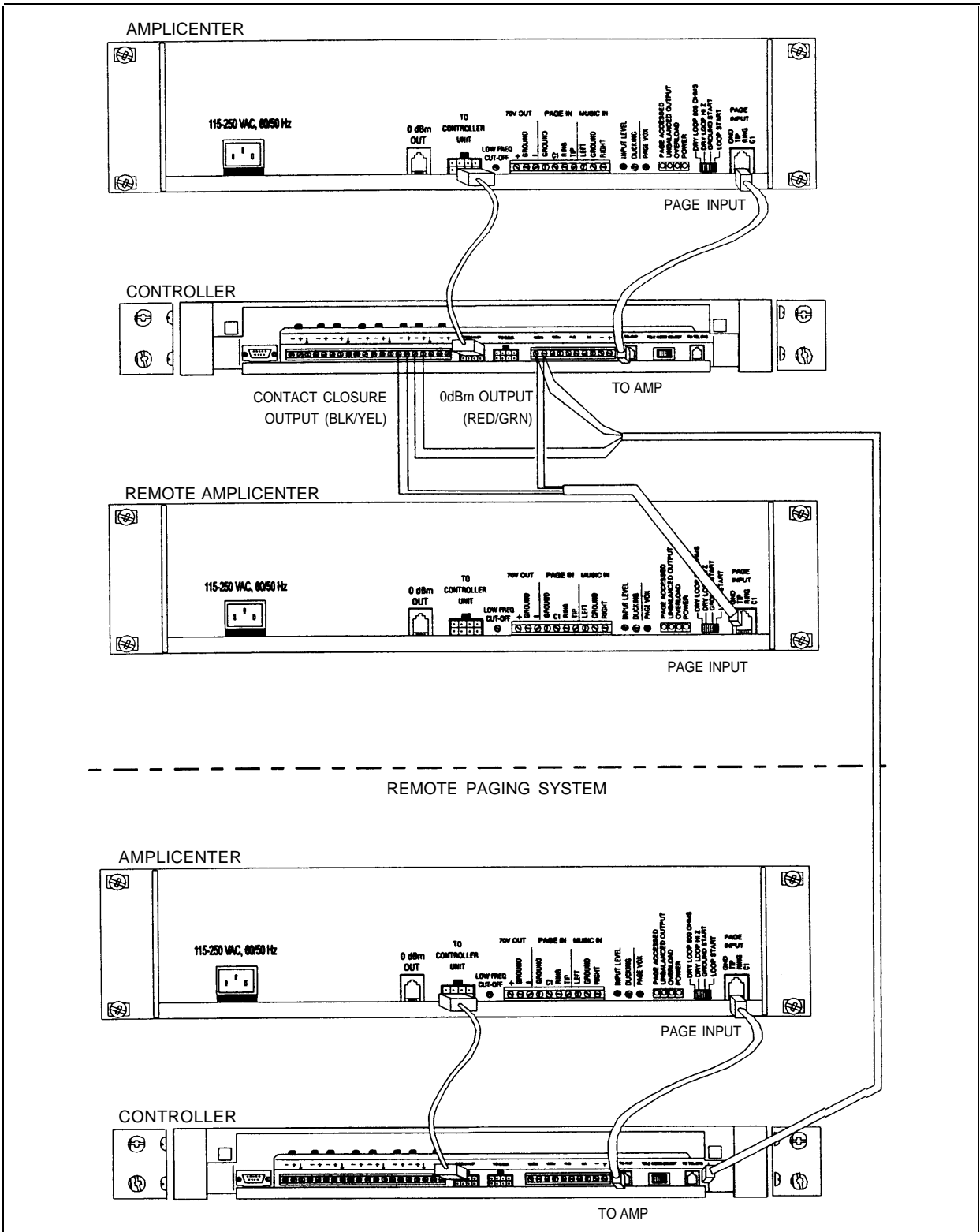

Figure 28. Connecting Additional Controllers and Remote Amplifiers

© 1994 AT&T
All rights reserved
Printed in U.S.A.

CIC#463-248-201
011722051-000
Issue 5, October 1994