

AT&T

Page Pac[®] Plus Paging Controller

Programming and Operation Guide

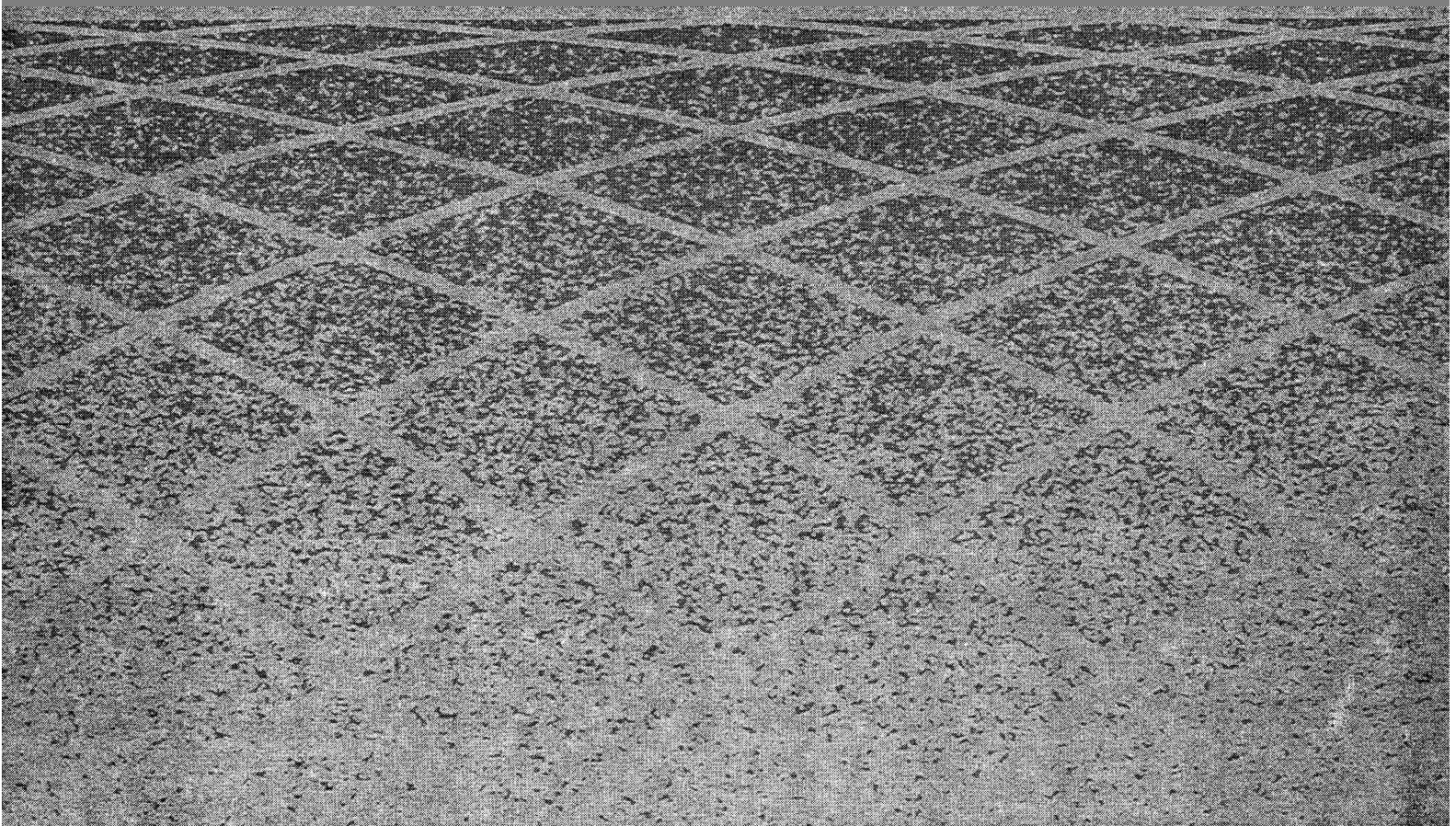

Notice

Every effort was made to ensure that the information in this guide was complete and accurate at the time of printing. However, information is subject to change.

Federal Communications Commission (FCC) Interference Notice

This equipment has been tested and found to comply with the limits for a Class A digital device, pursuant to Part 15 of the FCC rules. These limits are designed to provide reasonable protection against harmful interference when the equipment is operated in a commercial environment. This equipment generates, uses, and can radiate radio frequency energy and, if not installed and used in accordance with the instruction guide, may cause harmful interference to radio communications. Operation of this equipment in a residential area is likely to cause harmful interference, in which case the user will have to correct the interference at his or her own expense. For additional FCC interference, registration, and repair information, see the *Installation Guide*.

Trademarks

PAGEPAC PLUS and AMPLICENTER are trademarks of Harris-Draccon. Centrex is a registered trademark of AT&T.

Warranty

AT&T provides a limited warranty for this product. Refer to "AT&T Limited Warranty and Limitation of Liability" in the *Installation Guide*.

Ordering Information

The order number for this book is 463-248-204. To order copies of this book, call 1-800-432-6600 in the U.S. and 1-800-255-1242 in Canada. For more information on how to order this and other system reference materials, see "Reference Materials," in "About this Guide." For information on ordering replacement parts, accessories, and other compatible equipment, refer to "Product Ordering information," under "About This Guide".

Support Telephone Numbers

AT&T provides a toll-free customer helpline 24 hours a day.

In the U.S., call the AT&T NTSC Group at 1-800-552-3293 or the AT&T Helpline at 1-800-628-2888 if you need assistance when installing, programming, or using your system. For service or technical assistance in Canada, call one of the following Technical Assistance Centers:

Eastern Canada and Ottawa:	1-800-363-1882
Ontario:	1-800-387-4268
Central and Western Canada:	1-800-663-9817

Contents

About This Guide

vii

- How to Use This Guide vii
 - Getting Started viii
 - How to Comment on This Guide viii
 - Product Ordering Information viii
 - Reference Materials viii
-

1. Overview

1-1

- About PagePac Plus 1-3
 - Managing the System 1-6
 - Features and Capabilities 1-7
 - Hardware Configuration 1-10
 - Indicators and Connectors 1-11
 - Power 1-14
 - Interface Considerations 1-15
 - Zone Map 1-16
 - Zone Configuration Tables 1-22
-

2. Programming The Controller

2-1

- Introduction 2-3
- Software Configuration—Overview 2-4
- Programming Options and Instructions 2-5
- Error Tones 2-36
- Programming Quick Reference Chart 2-37

3.	Operation	3-1
	■ Power Up	3-2
	■ System Administrator	3-2
	■ End User	3-2
	■ User Quick Reference Card	3-4

A.	Application Notes	A-1
-----------	--------------------------	------------

IN.	Index	IN-1
------------	--------------	-------------

About This Guide

READ THIS GUIDE FIRST, before using the *Installation Guide* to install PagePac Plus equipment. You will need to complete the Zone Map (table 1-2) and Zone Configuration Tables (tables 1-3 and 1-4) to lay out your paging system zones before setting switches on the equipment and before programming the controller unit.

After programming the unit, fill out the User Quick Reference Card, at the end of section 3, and distribute to all system users.

NOTE TO INSTALLER

Leave this guide with the System Administrator or other person responsible for managing/modifying the PagePac Plus system.

This guide explains features, and their application, to program the PagePac Plus Control Unit to provide the paging functions that your facility requires.

It also gives complete instructions for operating the PagePac Plus system from your phone, once it's installed and configured.

The pronoun "he," as used herein to refer to the user, is intended to encompass users of either gender.

How to Use This Guide

- **Overview and Features.** For a thorough description of PagePac Plus capabilities and features, refer to section 1.
- **Programming Instructions.** Section 2 provides step-by-step instructions for programming the configuration of your PagePac Plus paging system, using a Touchtone telephone keypad. For programming instructions using a PC computer, see the separate instructions accompanying the software diskette. Section 2 describes in detail the various configuration options that are to be selected. You can change your system's settings easily to accommodate new or expanding needs.
- **Operations Instructions.** Section 3 gives step-by-step instructions for using your PagePac Plus-controlled paging system, once its configuration has been set. A User Quick Reference Card is included at the end of section 3.
- **Equipment Installation.** For detailed instructions about installing the PagePac Plus Control Unit, Zone Expansion Unit(s), Amplicenter(s), and interconnect cabling, refer to the *Installation Guide.*]

-
- **Solving Problems.** Should any problem arise that requires technical assistance beyond the information provided in this guide, call:

AT&T Technical Support, 1-800-552-3293.

AT&T National Technical Marketing, 1-800-222-1313.

AT&T National Service Assistance Center, 1-800-628-2888.

Getting Started

1. Fill out the Zone Map (table 1-2) and Zone Configuration Tables (1-3 and 1-4) at the end of section 1.
2. Go to the Programming Quick Reference Chart at the end of section 2 and program the system.
3. Fill out the User Quick Reference Card, at the end of section 3, to distribute to all system users.

How to Comment on This Guide

A feedback form is located at the end of this guide. If the feedback form is missing, send your comments and recommendations for changes to:

J. Dean
AT&T
99 Jefferson Road (Room 2A-25)
Parsippany, NJ 07054
FAX: (201) 887-6898

Product Ordering Information

Refer to PagePac Plus Controller Installation and Use Guide for product ordering information.

Reference Materials

- PagePac Plus Controller Installation and Use 463-248-201
- PagePac Plus Amplicenter Service Manual 463-248-202
- PagePac Plus Zone Expansion Unit Service Manual 463-248-203

Overview

1

Contents

About PagePac Plus	1-3
Managing the System	1-6
■ Installing System Hardware	1-6
■ Changing System Settings	1-6
■ Training Co-Workers	1-6
■ Solving Problems	1-6
■ Daily Operation	1-7
■ Application Notes	1-7
Features and Capabilities	1-7
■ Factory-Set Default Inputs	1-8
■ Eight Primary Paging Zones	1-9
■ 48 Expansion Zones	1-9
■ PagePac Plus Amplicenter Interface	1-9
■ Music Input	1-9
■ Three Output Types	1-10
■ Talk-Back Amplifier	1-10
■ Tone Generator	1-10
■ Programming Memory	1-10

Hardware Configuration	1-10
Indicators and Connectors	1-11
■ LED Indicators	1-11
■ Back Panel Nomenclature	1-11
■ Connectors on Rear	1-14
Power	1-14
Interface Considerations	1-15
Zone Map	1-16
Zone Configuration Tables	1-22

About PagePac Plus

- Telephone Access and Talk-back** The PagePac Plus Controller is a paging system controller that incorporates into one unit many paging system features previously obtainable only by purchasing multiple separate units. It is bi-directional, enabling two-way (talk-back) conversation via the paging system. PagePac Plus supports numerous modes of Telephone Access to the paging system, which allows you to access the system by simply dialing its extension, in-facility or off-premises. All access to the paging system can be password protected.
- Security Door Control and Night Bell** The PagePac Plus Controller is set up to accommodate security door or gate control, enabling you to speak with whomever has rung the door bell, and to signal the door lock to open, permitting entry. PagePac Plus also features Night Bell circuitry, which enables the paging system to alert personnel to incoming phone calls in unoccupied areas, after hours.
- Automatic Message Logging** The PagePac Plus Controller may optionally be connected to a PC computer for automatic logging of all important paging activity, for security and insurance purposes.
- PagePac Plus Amplicenter** The PagePac Plus Controller requires connection to a PagePac Plus Amplicenter, which amplifies and distributes sound to paging loudspeakers, and to which the music source for background music is connected. The PagePac Plus Amplicenter is also the power source for the controller. The Amplicenter is available in 20, 100, and 300 watt models.
- Zone Expansion Units** The PagePac Plus Controller may be connected to Zone Expansion Units, which enlarge the paging controller's capacity to a maximum of 56 paging zones. See figure 1-1, PagePac Plus System Components, for a typical example of a PagePac Plus system hardware layout.
- Easy to Program** PagePac Plus is user-programmable, with simple step-by-step programming instructions that permit the system administrator or other responsible person to alter the system configuration, using either a standard Touchtone telephone keypad or a PC computer. As your paging needs change, you can alter the makeup of paging zones, and the nature of inputs and outputs. You can expand the controller's program to add additional paging zones, all within a few minutes time and without the need for a paging system technician to come in to do the job.

Security Protection

An Access Password and a Programming Password can easily be established for the PagePac Plus system. Both passwords are operative for both on- and off-premises access, and the Programming password is effective for both telephone keypad and PC programming access.

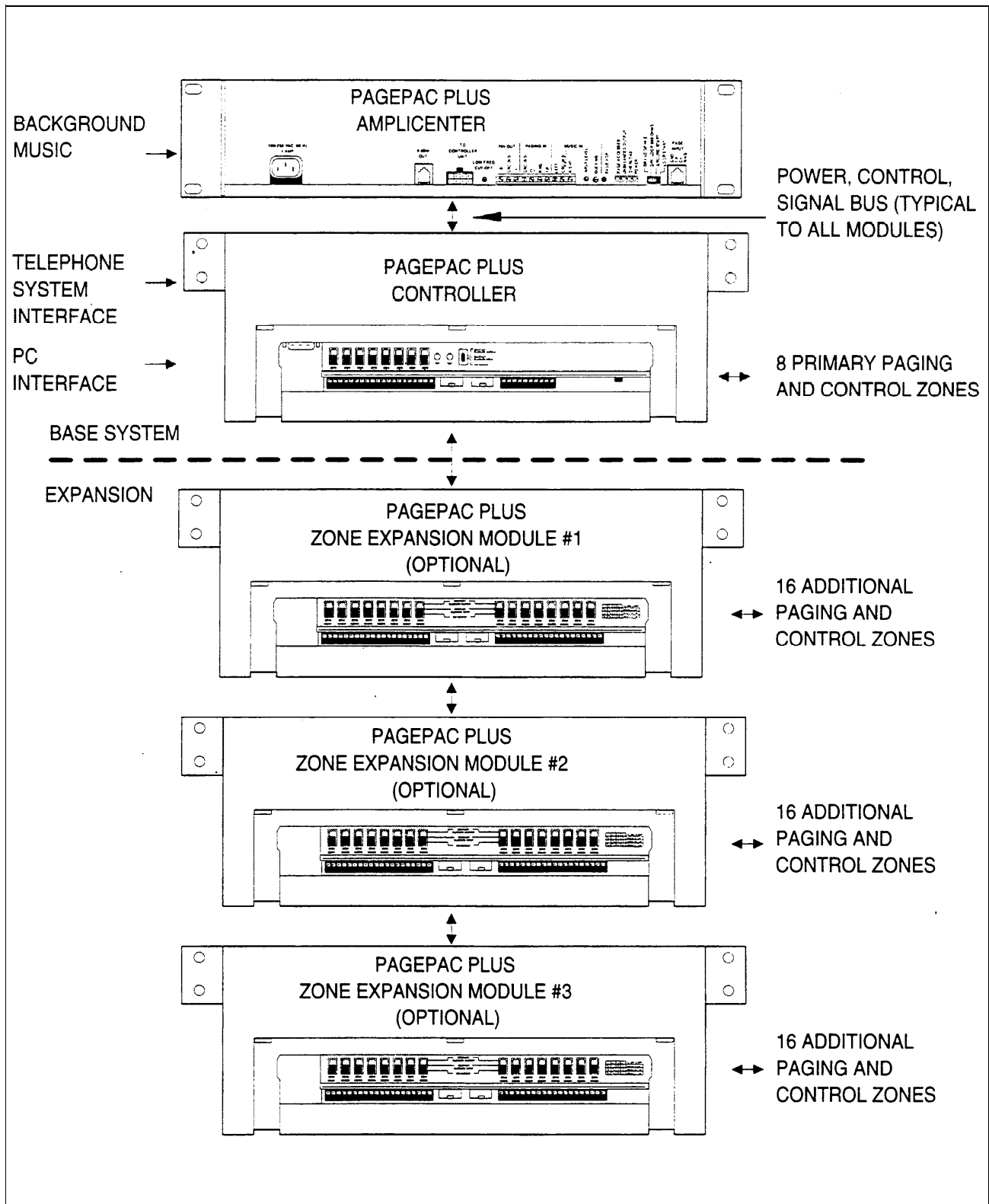

Figure 1-1. PagePac Plus System Components

Managing the System

Installing System Hardware

Please refer to the *Installation Guide* for complete instructions for installing the PagePac Plus Unit, Amplicenter, and Zone Expansion Units, to form a fully integrated functional paging controller system in your facility.

Changing System Settings

You can change the Control Unit's settings easily to accommodate new or changing needs. Section 2 gives instructions for making whatever changes are needed – by using your telephone keypad or a PC computer to re-configure parameters stored in the PagePac Plus's memory. You can change the manner in which paging zones are laid out, or you can re-define the nature of the inputs and outputs of the system.

Training Co-Workers

Section 3, "Using the PagePac Plus Paging System," explains how to use your telephone set to access the paging system, how to select paging zones, how to answer a door bell and unlock the door, and other features. To help with this task, give each telephone user a copy of the User Quick Reference Card, found at the end of section 3.

Solving Problems

The *Installation Guide* gives information on solving installation problems and ordering additional accessories and equipment. If your system malfunctions, you may be able to solve the problem by following the steps provided in the "Maintenance and Troubleshooting" section of the *Installation Guide*. If you receive error tones or error messages from the system, refer to "Error Tones" at the end of section 2. If you still need help, call the 24-hour AT&T National Service Assistance Center:

1-800-628-2888.

Daily Operation

Depending on how your system is set up, you may need to oversee some of the system's daily operation. For example, if your system is programmed to use the Night Bell feature, you will need to activate Night Bell service at the end of each day before leaving the office.

Application Notes

Application Notes are located at the end of this guide, after section 3. They provide technical tips and graphic examples of some common applications.

Features and Capabilities

The following list provides an overview of the basic features of the PagePac Plus system, along with the additional capabilities that you can get by customizing the system:

- Connects up to 8 paging zones, or up to 56 if Zone Expansion Unit(s) are attached.
- Enables access to the paging system via any telephone.
- Combines simplicity of use with a wide range of paging system features, including:

Attendant (microphone) Access

Night Bell

Talk-back (2-way paging)

Door Phone / Door Control

Remote Amplifier Control

Alarm System Interface

Contact closure outputs to turn on (for example) the exterior lighting

Background Music

Automatic logging of paging activity

- Can be re-programmed easily from any telephone in the system, or by using a PC with the software program provided. A Programming password (if optioned) protects the system from unauthorized programming access.

Factory-Set Default Inputs

The PagePac Plus Control Unit has five factory-set default inputs that are active on a priority basis. These five, in order of priority, are Attendant Access, Input #1, Telephone Access, Input #2, and Night Bell.

Attendant Access

Attendant Access is the highest priority paging mode of the PagePac Plus system. The attendant simply dials his exclusive paging extension to make an announcement. Also, by using a microphone directly connected to the PagePac Plus Controller, the Attendant activates paging access when the microphone "TALK" switch is pressed. Any other paging activity (or background music) that may be currently active will be muted or overridden, to permit the direct voice page to be broadcast.

Input #1

Input #1 is the second highest priority, and is intended for inputs such as a security alarm or fire alarm, though it is user-definable and can be used for any input.

Telephone Access

The Telephone Access is made by dialing the general access extension number of the PagePac Plus unit. The PagePac Plus telephone interface is switch selectable (set to accommodate your telephone system) and has the third highest paging priority. See the *Installation Guide* for details of the four different telephone system modes.

Input #2

Input #2 is the fourth priority, and is intended for routine inputs such as a security door bell. It is user-definable and can be used for any designated input. Input #1 can only be assigned to zones 1 - 8.

Night Bell Circuit

When the *Night Bell* is activated and no other higher priorities are active, then a distinctive tone will be sent to all zones programmed to send Night Bell. The Night Bell circuit is activated by a ring voltage from a PBX station or a zone input contact closure. The default priority is the lowest.

Eight Primary Paging Zones

NOTE: The Zone Option switches, both on the PagePac Plus Controller and on any attached Zone Expansion Units, MUST be set before the PagePac Plus system is powered up, and therefore before programming commences.

The PagePac Plus Control Unit has eight onboard zones. All eight zones can be optioned via zone option switches (on the rear of the controller) to be either 70V audio output zones, input contact-closure zones, or contact-closure output zones to drive additional remote amplifiers or other devices such as security door locks. Each zone may be configured individually. If a zone is optioned as an input, its priority will be set by identifying it as an Input #1 or Input #2 zone.

48 Expansion Zones

NOTE: Each Zone Expansion Unit has a dip switch that must be set (addressed) properly during installation, and before power up of the system. See Installation Guide.

The PagePac Plus Control Unit has the ability via Zone Expansion Units to access up to 48 external paging zones. It communicates with these expansion zones by using up to three optional Zone Expansion Units (16 zones per module).

PagePac Plus Amplicenter Interface

The PagePac Plus Controller connects to and controls a PagePac Plus Amplicenter. The controller draws its internal power from the amplifier and routes the amplifier's audio power to the proper zone(s).

Music Input

The background music source is connected to the PagePac Plus Amplicenter, then its audio signal is passed on to the PagePac Plus Controller for distribution to zones. The music input will always have the lowest paging priority. Since the amplifier has a music input volume adjustment, it can accommodate various input signal levels, such as tape, CD, or radio.

Three Output Types

The PagePac Plus Control Unit has three audio outputs, with the level controlled by an automatic gain control (AGC) to ensure excellent voice clarity. The first is the audio output signal to the PagePac Plus Amplicenter, in a Constant-Voltage Distribution System (see "Hardware Configuration," below.)

The second audio output is intended to drive (for example) an additional PagePac Plus Control Unit. Only one external device may be connected to this output if talk-back is required.

The third output is intended to drive up to 56 remote amplifiers, via Zone Expansion Units.

See the *Installation Guide* for details of connections.

Talk-Back Amplifier

The talk-back amplifier has automatic gain control to ensure excellent voice clarity from audio received from paging zone speakers.

Tone Generator

The PagePac Plus Controller has the ability to generate several distinctive tones such as siren, chime, dial tone, beeps, and night bell. These tones may be sent to either the paging amplifier or to the telephone interface, depending on the situation. For a description of the tones, see "Tone Selection" in section 2, under Telephone Keypad Programming.

Programming Memory

The PagePac Plus Control Unit has the ability to retain all programming options in non-volatile (EEPROM) memory.

Hardware Configuration

The PagePac Plus system can be configured to operate in several different ways, as a constant-voltage distribution system, a controller system, or a hybrid system. In any of the configurations, a PagePac Plus Amplicenter is required and the interconnection between the Control Unit and the Amplicenter must be made.

Whether the PagePac Plus system is configured as a constant-voltage distribution system, a controller system, or as a hybrid system, has no bearing on programming and using the system.

For full information about connecting hardware, see the *Installation Guide*.

Constant-Voltage Distribution System

This is the "traditional" paging system configuration. When the system is configured as a constant-voltage distribution system, the 70V Amplicenter audio output is routed via the controller to any zone that is optioned for audio.

Controller System

In this configuration, the required PagePac Plus Amplicenter's audio will only be sent to a specific selected zone. Both remote audio amplifiers and amplified speakers can be controlled in this mode as well as other ancillary equipment requiring an audio output or a contact closure, or both.

Hybrid System

In this configuration the features of the constant-voltage distribution system and the features of the controller system will be combined. The controller will route the 70V audio to the proper audio zone and also have the ability to control remote amplifiers with zones selected as control closures.

Indicators and Connectors

LED Indicators

The PagePac Plus Controller has three LED indicators that are useful for installation and troubleshooting purposes.

Front panel

A single LED indicates the unit's power status: solid green indicates the unit has power, and blinking green indicates that the unit is in reset mode. A blinking power LED may indicate the need to power down and power up again, or that there is not enough AC power to the Amplicenter or DC power from the Amplicenter to the controller.

Rear panel

Two LEDs are adjacent to the eight zone option switches (see figure 1-2). The green LED lights to indicate that the *Telephone Access* interface has successfully been accessed by the telephone equipment. The yellow LED lights to indicate that *Attendant Access* interface has been successfully accessed.

Back Panel Nomenclature

The following items describe all back panel functions illustrated in figure 1-2:

Amplicenter:

- ① AC Power in; 110VAC at 60 Hz or 220VAC at 50 Hz
- ② OdBm out, control and audio for remote amplifier
- ③ DC Power and 70V audio out to controller
- ④ Bass (low frequency) control adjustment
- ⑤ 70V out; paging in (redundant to item #9); music in
- ⑥ Level adjustments: Music level, Music "ducking" (mute level), VOX audio level
- ⑦ LEDs: green - page accessed, red – unbalanced output, red – overload, green – power on
- ⑧ Telephone system mode switch: Dry loop 600 ohms, Dry Loop Hi Z, ground start, and loop start
- ⑨ From controller item #16 RJ11 connector (in constant voltage distribution system) audio and control

Controller Unit:

- ⑩ DB9 connector for the RS2232 port, which is used to connect a PC computer for programming (optional) or PC monitoring
- ⑪ Zone option 3-position zone slide switches: set to 70V audio out, contact closure input, or contact closure output
- ⑪A Zone connector for zones 1-8, plus, minus, and ground terminals
- ⑫ LEDs: Yellow - attendant access active, Green – tele. access active
- ⑬ DC Power and 70V audio from D-series amplicenter
- ⑭ DC Power, control, and audio 70V output to next expansion Unit
- ⑮ 10 position connector (pins 1/2) 0dB 600 ohm, (pins 3/4) 0dB out for additional controller and remote amplicenters, (pins 5/6) night bell input, (pins 7/8) control closure for attendant access input, (9/10) audio source (mic) attendant access input
- ⑯ Audio And Control to amplicenter RJ11 jack, item #9
- ⑰ Telephone mode switch: Dry Loop, station access, ground start, and loop start
- ⑱ Telephone system interface for PBX, KTS, or Centrex; standard RJ 11 connector

Zone Expansion Unit:

- ⑲ Zone connector for expansion zones: plus, minus, and ground terminals
- ⑲A Zone option 3-position zone slide switches: set to 70V audio out, control closure in, or control closure out
- ⑳ From controller: power, control, and audio or previous expansion unit
- ㉑ To Additional expansion unit: power, control, and audio
- ㉒ Selection and DIP switch when zone expansion units are used

Connectors on Rear

You have access to controls and connections on the back panel, which is covered with a removable lid (see figure 1-2). For instructions on installing the PagePac Plus system and making correct interconnects, see the *Installation Guide*.

- The rear panel of the PagePac Plus Control Unit contains:
- Two RJ11 telephone-type jacks, one for your PBX telephone system to connect to the PagePac Plus (Telephone Access) and one for the interconnect from the PagePac Plus to the PagePac Plus Amplicenter.
- A telephone interface mode selection switch (set during installation) to match your telephone system.
- A connector for the RS-232 port, which is used to connect a PC computer.
- A 10 position connector for Attendant Access inputs (from microphone or master telephone console), the Night Bell ringer input, and two audio outputs.
- A 20 position connector for zone connections and shields.
- Two 8-position connectors, one for the interconnect to the PagePac Plus Amplicenter, which supplies power and 70V audio to the controller, and one for an interconnect to Zone Expansion Units (if used).
- Eight 3-position zone switches, to manually configure a zone to be contact closure (switch), input, or audio output.

Power

Two DC voltages derived from the PagePac Plus Amplicenter (D-20, D-100, or D-300) via the interconnect cable are the source for all power required by the PagePac Plus Control Unit and any attached Zone Expansion Units.

See discussion of the front panel Power On LED, above under "LED Indicators."

Interface Considerations

The hardware installation configuration may have these impacts on programming and use of the PagePac Plus system:

Setting correct addresses for Zone Expansion Unit(s)

See the important explanation about setting the internal dip switches to address each Zone Expansion Unit, in the *Installation Guide*.

Telephone Mode

Be sure the telephone interface mode switch on the rear of the PagePac Plus unit has been set correctly, matching the telephone system of your facility (see ***Installation Guide***). However, whichever mode is selected has no bearing on programming or using the PagePac Plus Controller.

The default priority for telephone access is 3. The telephone input can access *any* zone or zone group to output audio paging or to trigger an output contact-closure action. Programming can also be accomplished via telephone access.

Zone Option Switches on Control Unit

The eight Zone Option switches on the rear of the PagePac Plus Controller MUST be set to match the zone option to be programmed.

The slide switch for each zone must be manually set to Contact Closure (to switch on/off a device, such as a door security lock, remote amplifier, etc.), Input (such as doorbell or security alarm), or Audio Output, depending on the programmed mode selected for each zone. See Zone Map (table 1-2) and Zone Configuration Tables (1-3 and 1-4), below (both to be filled out).

The Zone Option switches must be set before the PagePac Plus system is powered up, and therefore before programming commences.

Zone Expansion Unit Option Switches

The 16 Zone Option switches on the Zone Expansion Unit must also be configured to match the intended zone mode. It is recommended that the paging zone decisions be made prior to beginning programming. See Zone Map (table 1-2) and Zone Configuration Tables (1-3 and 1-4), below (both to be filled out).

The Zone Option switches and dip switches on Zone Expansion Unit(s) must be set prior to system power-up.

Other Interfaces

Night Bell, Music Input, Computer Monitor Logging, Alarm System, and Door Control interfaces are illustrated in the Application Notes, at the end of this guide.

Zone Map

The Zone Map is to be filled out by your system administrator or the person responsible for programming your PagePac Plus system. It assists in identifying the zones, both inputs and outputs, of your particular system. Make photocopies of the blank Zone Map to use in laying out your system. Refer to the example Zone Map for an idea how to proceed.

Description of Zone

Write a brief description of each zone in your facility.

Physical Zone Number

Preprinted on the form, this number identifies the zones and groups.

Physical Zone Code

Preprinted on the form, these are the physical addresses (default dial codes) of the different zones. You would dial this code for a zone if no ALIAS number has been assigned.

NOTE: If an ALIAS number is assigned to any zone, ALIAS numbers must be assigned to ALL zones.

ALIAS Zone Number

Using ALIAS zone numbers is optional. An ALIAS number for zone is the extension number you intend to dial to reach this zone. All ALIAS numbers must have the same number of digits (all 3-digit, or all 4-digit codes). When assigning ALIAS zone numbers, consider assigning consecutive numbers to similar zones. Choose numbers that are relatively easy to remember and easy to enter into the telephone keypad. If you choose not to use ALIAS numbers, you will use the Physical Zone Codes, above, to dial the zones.

Input or Output

Write an I-1, I-2, or an O to indicate the type of zone. I-1 means input priority level 1; I-2 means input priority 2. "Input" and "output" here mean inputs to or outputs from the controller.

NOTE: Attendant Access, Telephone Access, Night Bell, and Music input are default inputs to the PagePac Plus, and are not to be identified as zones. Computer Monitor is an optional output device connected to the PagePac Plus, and is also not to be identified as a zone.

After completing your Zone Map, you are ready to set System Options (beginning with table 2-1 in section 2) and then do Zone Map programming (table 2-12).

Table 1-1. Zone Map Example

Description of Zone	Physical Zone Number	Physical Zone Code	ALIAS* Zone Number	Input (1 or 2) or Output
Warehouse Area Paging	Zone 2	02	212	0
Shipping/Receiving Area Paging	Zone 3	03	213	0
Doorbell: Security Door, S/R Dock	Zone 4	04	223	I-2
Speaker-phone: Security Door, S/R Dock	Zone 5	05	221	0
Door Lock: Security Door, S/R Dock	Zone 6	06	222	0
Garage Area Paging	Zone 7	07	214	0
Security Alarm System input	Zone 8	08	231	I-1
All Call: Group all paging (for audio): zones 1,2,3, & 7	Group 1	80	241	0
Group warehouse / shipping area paging zones: 2 & 3	Group 2	81	242	0

* Optional

Table 1-2. Zone Map

Description of Zone	Physical Zone Number	Physical Zone Code	ALIAS* Zone Number	Input (1 or 2) or Output
	Zone 2	02		
	Zone 3	03		
	Zone 4	04		
	Zone 5	05		
	Zone 6	06		
	Zone 7	07		
	Zone 8			
For Zones 9 thru 56, see Zone Map Continuation Pages.				
	All Call	80		
	Group 1	81		
	Group 2	82		
	Group 3	83		
	Group 4	84		
	Group 5	85		
	Group 6	86		
	Group 7	87		
	Group 8	88		

* Optional

Table 1-2. Zone Map (Continuation Page 1)

Description of Zone	Physical Zone Number	Physical Zone Number	ALIAS* Zone Number	Input (1 or 2) or Output
Zones 9 thru 24 are located on the first Zone Expansion Unit.				
	Zone 09	09		
	Zone 10	10		
	Zone 11	11		
	Zone 12	12		
	Zone 13	13		
	Zone 14	14		
	Zone 15	15		
	Zone 16	16		
	Zone 17	17		
	Zone 18	18		
	Zone 19	19		
	Zone 20	20		
	Zone 21	21		
	Zone 22	22		
	Zone 23	23		
	Zone 24	24		

* Optional

Table 1-2. Zone Map (Continuation Page 2)

Description of Zone	Physical zone number	Physical Zone Code	ALIAS* Zone Number	Input (1 or 2) or Output
Zones 25 thru 40 are located on the second Zone Expansion Unit.				
	Zone 25	25		
	Zone 26	26		
	Zone 27	27		
	Zone 28	28		
	Zone 29	29		
	Zone 30	30		
	Zone 31	31		
	Zone 32	32		
	Zone 33	33		
	Zone 34	34		
	Zone 35	35		
	Zone 36	36		
	Zone 37	37		
	Zone 38	38		
	Zone 39	39		
	Zone 40	40		

* Optional

Table 1-2. Zone Map (Continuation Page 3)

Description of Zone	Physical Zone Number	Physical Zone Code	ALIAS* Zone Number	Input (1 or 2) or Output
Zones 41 thru 56 are located on the third Zone Expansion Unit.				
	Zone 41	41		
	Zone 42	42		
	Zone 43	43		
	Zone 44	44		
	Zone 45	45		
	Zone 46	46		
	Zone 47	47		
	Zone 48	48		
	Zone 49	49		
	Zone 50	50		
	Zone 51	51		
	Zone 52	52		
	Zone 53	53		
	Zone 54	54		
	Zone 55	55		
	Zone 56	56		

* Optional

Contents

Introduction	2-3
■ Programming by Touchtone Telephone	2-3
■ Programming by PC	2-3
Software Configuration—Overview	2-4
■ Zone Group versus Individual Zones	2-4
■ At Power Up	2-4
Programming Options and Instructions	2-5
■ Enter Programming Mode	2-5
■ System Configuration Options Overview	2-5
■ Reset to Factory Defaults	2-6
■ Define Length of ALIAS Numbers	2-7
■ Connect Password	2-8
■ Programming Password	2-10
■ Forgot the Password?	2-11
■ Confirmation Tone ON/OFF	2-11
■ Pre-Announcement Tone ON/OFF	2-12
■ Talk-Back Warning Tone	2-13
■ VOX Disconnect Timing	2-14

■ Computer Monitor	2-15
■ Input Computer Monitor	2-16
■ General Zone / Group Configurations Overview	2-16
■ COPY Command	2-17
■ Zone Map Option—Assigning ALIAS Numbers	2-18
■ Type of Zone: Input or Output	2-19
■ Input Priority Arrangement	2-20
■ Zone Monitor	2-21
■ Zone Grouping	2-22
■ Output Zone/Group Configurations Overview	2-23
■ Type of Output	2-23
■ Page Enable	2-25
■ Music Enable	2-26
■ Talk-Back Enable	2-27
■ Night Bell Enable	2-28
■ Pass DTMF to the Output	2-29
■ Input Zone / Group Options Overview	2-31
■ Tone Selection	2-31
■ Tone Routing	2-33
■ Audio Source Enable	2-34
■ Audio Routing	2-35
Error Tones	2-36
Programming Quick Reference Chart	2-37

Introduction

The operation of the PagePac Plus Controller can be customized to meet the requirements of your business. It can be programmed in either of two ways, using a telephone keypad or a PC, and nearly all features¹ can be programmed by either method.

The zone option switches on the controller and on any attached Zone Expansion Unit(s) MUST be set before the PagePac system is powered up.

Programming by Touchtone Telephone

This section details the programming the PagePac Plus Controller by using the telephone keypad to enter your selections. This programming method works via the Telephone Access port, which accepts only Touchtone telephone keypad inputs (DTMF). The PagePac Plus Controller itself has the ability to retain the programming options indefinitely, in its onboard memory.

See the Programming Quick Reference Chart at the end of this section for a summary of programming steps.

Programming by PC

The second means of programming is using an IBM-compatible PC (personal computer), which connects to an RS-232 port on the back of the controller by means of a crossover cable (also called a null-modem cable).

NOTE: The PagePac Plus unit can be configured remotely via the RS-232 port using a modem.

An advantage of using a PC to configure the PagePac Plus unit is that screens can be viewed on the monitor to aid in selecting the zones for various options. Using a PC to program the PagePac Plus Controller, you can view the system as a diagram, see your options, and observe the changes being made. Your programming can be saved to a computer file on a diskette and recalled in the future.

In either case, the controller itself has the ability to retain the programming options indefinitely.

¹Only the International Timing option requires programming via the PC. The default setting for this option is USA/Canada.

Software Configuration—Overview

The PagePac Plus Controller is pre-programmed with certain default values when shipped. However, not all paging systems will have the same requirements, and therefore you (or the installation technician) may want or need to change the options on the system.

Some of the various programming configurations, which are presented in detail later in this section, include:

- The ability to option a zone as an audio output zone, as either of two levels of input zone, or as an output contact-closure zone.
- If a zone is optioned as a paging zone or a switch-closure zone, then other options are available, such as zone grouping.
- Zone groups and individual zones can be configured to perform a variety of functions such as page enabled/ disabled or talk-back enabled/disabled.
- If a zone is selected to be input, then options may be selected such as energizing an output switch-closure zone(s), whenever the input is active, or a selected tone can be sent out to selected zones whenever the input is active.
- If multiple zones are configured as inputs with the same priority (for example, two zones coded I-I), access will be granted on a first-come, first-served basis.
- Zone mapping is also permitted.

Zone Group versus Individual Zones

The PagePac Plus Controller can be optioned at two different levels, Zone Group and Individual Zone programming. Zone group configurations will override individual zone configurations whenever a zone group is selected.

At Power Up

When the PagePac Plus Controller is first powered up, it polls the zones to determine how many (if any) zone expansion units are present. The PagePac Plus has the capacity to serially access up to 48 external zones.

The Zone Option switches, both on the controller and on any attached Zone Expansion Units, must be set before the PagePac Plus system is powered up, and therefore before programming commences.

Programming Options and Instructions

⚠CAUTION:

The Zone Option switches must be set before the PagePac Plus system is powered up, and therefore before programming commences.

The 8 Zone Option switches on the rear of the PagePac Plus unit **MUST** be set to match the zone option selected via programming. The slide switch for each zone must be manually set to Contact Closure (to switch on/off a device, such as a door security lock, remote amplifier, etc.), Input, or Audio Output, depending on the mode selected for each zone.

The 16 Zone Option switches on the Zone Expansion Unit **MUST** also be configured to match the zone modes you intend to program.

It is recommended that the paging zone decisions be made and diagramed prior setting these switches. See Zone Configuration Tables (1-3 and 1-4 in section 1, to be filled out) and programming instructions, below.

Enter Programming Mode

To enter the programming mode:

1. Access the PagePac Plus system via the telephone interface (dial the paging access extension).
2. Dial the Connect password (if optioned). (See Connect Password, below.)
Hear the PagePac Plus dial tone.
3. Dial [*][*]. Hear confirmation tone and then dial tone again.
4. Dial the Programming password (if optioned). (See Programming Password, below.)
5. Program the system options (go on to the next paragraphs). You may exit the programming mode by dialing [#].

System Configuration Options Overview

System Configuration Options are options that effect the entire system, and are not specific or unique to any one zone or zone group. See the Programming Quick Reference Chart at the end of this section for a listing of these. The paragraphs below provide instructions for programming these system options (from a telephone keypad), if you wish to change them.

Reset to Factory Defaults

This system option allows you to "undo" all system changes you have made, in order to "start over." This Reset option takes all programmed options and restores them to their factory default settings.

First access the PagePac Plus system and enter the programming mode by pressing [*][*] and entering your Programming password (if optioned). You may exit the programming mode by dialing [#].

1. Dial [1][0] to select this option.
Hear a DOUBLE beep.
2. Enter [2][5][3][2][7] to reset. (Enter any invalid number string to escape.)
Hear TRIPLE beeps.

Note that the factory default condition for Connect password is NO password, and for Programming password the default is [*][*].

These actions are summarized in table 2-1.

Table 2-1. Reset to Factory Defaults

Feature	Mode Option/ Verify	Dial	Listen For	Choose Option	Listen For	Default
Reset to Factory Defaults	To Select	10	Double Beep	Enter 25327 to reset. Enter any invalid number string to escape.	Triple Beeps	25327 (CLEAR)

Define Length of ALIAS Numbers

This system option allows you to set the length (2, 3, or 4 digits) of the ALIAS number field. The default is 2 digits. If you wish to assign ALIAS numbers to the paging zones, you must set the length parameter. The ALIAS number is the dialing extension for the zone. If no ALIAS numbers are used, the Physical Zone Code is the dialing extension for a zone.

This MUST be done before "Zone Map Option – Assigning ALIAS Numbers", later in this section. (see table 2-12)

Programming Steps

First access the PagePac Plus system and enter the programming mode by pressing [*] [*] and then entering your Programming password (if optioned). You may exit the programming mode by dialing [#].

1. Dial [*] [0] to select this option.

Hear a DOUBLE beep.

2. Enter [*] [3] or [*] [4], to set length of ALIAS number filed (number of digits).

Hear TRIPLE beeps.

To verify the setting, dial [*] [1] and repeat step 2 above.

These actions are summarized in table 2-2.

Table 2-2. Defining Length of ALIAS Numbers

Feature	Mode Option/ Verify	Dial	Listen For	Choose Option	Listen For	Default
Number of Zone Map Digits	To Select To Verify	20 21	Double Beep	2 (digits) 3 (digits) 4 (digits)	Triple Beeps	2

Connect Password

This feature will not become active until the first time you enter a password, via the programming mode. The factory default is NO password.

The Connect password operates as a security block into the paging system, restricting paging access to authorized users.

You may want to use a short Connect password (2 or 3 digits only) for ease of use.

When a user accesses the PagePac Plus unit via Telephone Access, a dial tone will be returned to the user. At this time the user will have unlimited chances to enter the correct password. If the correct password is entered, the user will receive the confirmation tone, then a new dial tone from the PagePac Plus unit, and then can either select a zone, zone group, or enter the programming mode.

If the wrong password is entered, the user will not receive any confirmation tone or new dial tone. He can continue to enter digit strings (without hanging up) until the correct password is entered, or he can hang up and try again by re-accessing the paging system.

In the event that the user forgets the password, see "Forgot the Password?"

Programming Steps

First access the PagePac Plus system and enter the programming mode by pressing [*][*] and entering your Programming password (if optioned). You may exit the programming mode by dialing [#].

1. Dial [*][*] select this option.

Hear a DOUBLE beep.

2. Enter the Password you wish to use (up to 6 digits). If the password has fewer than 6 digits, enter the [#] to terminate the string.

For example, [1][2][3][4][5][6] is a valid password entry. [1][2][3][#] is also a valid password entry, resulting in the password [1][2][3].

If you already have entered a password and want to remove it (to have NO password), just enter the [#] alone.

Hear TRIPLE beeps.

To verify that the new Connect password has been established, dial [*][1] and repeat step 2 above.

These actions are summarized in table 2-3.

Table 2-3. Selecting a Connect Password

Feature	Mode Option/ Verify	Dial	Listen For	Choose Option	Listen For	Default
Connect Password	To Select To Verify	30 31	Double Beep	Enter Password, enter # to terminate the string	Triple Beeps	None

Programming Password

Establishing a Programming password will restrict access to the programming mode of the PagePac Plus paging system. It is recommended that access to programming be restricted to the System Administrator, Telecommunications Manager, or other selected users.

This feature will become active once any programming password has been entered via the programming mode. You are not required to establish such a password. The factory-set default programming password is [*][*]. Your Connect and Programming passwords should not be the same.

If this feature is active and the system has been accessed via the telephone interface, then after the first digit of your Programming password is pressed, the dial tone will stop and will not be returned until the correct password is entered or until the user hangs up and re-enters the system.

Programming Steps

First access the PagePac Plus system and enter the programming mode by pressing [*][*] and entering your Programming password (if previously optioned). You may exit the programming mode by dialing [#].

1. Dial [3][2] to select this option.
Hear a DOUBLE beep.
2. Enter the Password you wish to use (up to 6 digits). If the password has fewer than 6 digits, enter the [#] to terminate the string.

For example, [2][3][4][5][6][7] is a valid password entry. [2][3][4][#] is also a valid password entry, resulting in the password [2][3][4].

If you already have entered a password and now want to remove it (to have NO password), just enter the [#] alone.

Hear TRIPLE beeps.

To verify that the new Programming password has been established, dial [3][3] and repeat step 2 above.

These actions are summarized in table 2-4.

Table 2-4. Selecting a Programming Password

Feature	Mode Option/ Verify	Dial	Listen For	Choose Option	Listen For	Default
Programming Password	To Select To Verify	32 33	Double Beep	Enter Password, enter # to terminate the string	Triple Beeps	* *

Forgot the Password?

In the event that either or both the connect password and programming password are forgotten, it will be necessary to call the Harris-Dracon Technical Help line (1-800-437-2266) for instructions how to erase the two passwords and be able to enter new ones.

Confirmation Tone ON/OFF

Your choice for this selection is ON or OFF, with the default setting as ON. When the option is ON, a tone will be sent to the telephone interface after a zone has been selected and before a page can be made.

Programming Steps

First access the PagePac Plus system and enter the programming mode by pressing [*] [*] and entering your Programming password (if optioned). You may exit the programming mode by dialing [#].

1. Dial [*] [*] to select this option.
Hear a DOUBLE beep.
2. Dial [*] to turn OFF. Dial [*] to turn ON.
Hear TRIPLE beeps.

To verify the condition (OFF or ON) of the Confirmation tone, dial [*] [*] and repeat step 2 above.

These actions are summarized in table 2-5.

Table 2-5. Confirmation Tone ON/OFF

Feature	Mode Option/ Verify	Dial	Listen For	Choose Option	Listen For	Default
Confirmation Tone	To Select To Verify	40 41	Double Beep	0 — Off 1 — On	Triple Beeps	On

Pre-Announcement Tone ON/OFF

The choice for this parameter is ON/OFF, with the default setting ON. This tone is very similar to the initial talk-back warning tone, in the sense that it is sent to a zone when the zone is accessed. This tone will be sent out to both the zone selected and to the telephone interface. After this tone is sent, you may begin your page message.

Programming Steps

First access the PagePac Plus system and enter the programming mode by pressing [*] [*] and entering your Programming password (if optioned). You may exit the programming mode by dialing [#].

1. Dial [4] [2] to select this option.

Hear a DOUBLE beep.

2. Dial [0] to turn OFF. Dial [1] to turn ON.

Hear TRIPLE beeps.

To verify the condition (OFF or ON) of the Pre-Announcement tone, dial [4] [3] and repeat step 2 above.

These actions are summarized in table 2-6.

Table 2-6. Pre-Announcement Tone ON/OFF

Feature	Mode Option/ Verify	Dial	Listen For	Choose Option	Listen For	Default
Pre-Announcement Tone	To Select	42	Double Beep	0 - Off	Triple Beeps	On
	To Verify	43		1 - On		

Talk-Back Warning Tone

This tone is intended to alert a person that their conversation is being monitored through the paging system loudspeaker. If Talk-back is optioned for YES, then the choices will be INITIAL, 30 SECOND REPETITION, or OFF. The default setting for this parameter is INITIAL and 30 SECOND REPETITION.

Programming Steps

First access the PagePac Plus system and enter the programming mode by pressing [*][*] and entering your Programming password (if optioned). You may exit the programming mode by dialing [#].

1. Dial [4][4] to select this option.

Hear a DOUBLE beep.

2. Dial [0] to turn OFF. Dial [1] to select INITIAL tone only. Dial [2] to select INITIAL and 30 SECOND repeat.

Hear TRIPLE beeps.

To verify the condition of the Talk-Back Warning tone, dial [4][5] and repeat step 2 above.

These actions are summarized in table 2-7.

Table 2-7. Talk-Back Warning Tone

Feature	Mode Option/Verify	Dial	Listen For	Choose Option	Listen For	Default
Talk-back Warning Tones	To Select To Verify	44 45	Double Beep	0 – Off 1 – Initial 2 – Initial and 30 sec.	Triple Beeps	<i>Initial and 30 sec.</i>

VOX Disconnect Timing

This is a loop supervision parameter for the station mode of the Telephone Interface. The PagePac Plus unit will return to an ON HOOK condition after no audio is detected in the page mode for the programmed amount of time. The default time is 30 seconds, but can be varied from 10 seconds to 60 seconds, in 10 second increments, or can be disabled completely.

Programming Steps

To alter the duration of the VOX Disconnect Timing, first access the PagePac Plus system and enter the programming mode by pressing [*][*] and entering your Programming password (if optioned). You may exit the programming mode by dialing [#].

1. Dial [5][0] to select this option.
Hear a DOUBLE beep.
2. Dial the code to select a duration for the VOX Disconnect Timing:
 - [0] to turn OFF
 - [1] to select 10 seconds
 - [2] to select 20 seconds
 - [3] to select 30 seconds
 - [4] to select 40 seconds
 - [5] to select 50 seconds
 - [6] to select 60 seconds

Hear TRIPLE beeps.

To verify the duration of the VOX Disconnect Timing, dial [5][1] and repeat step 2 above.

These actions are summarized in table 2-8.

Table 2-8. VOX Disconnect Timing

Feature	Mode Option/ Verify	Dial	Listen For	Choose Option	Listen For	Default
VOX Timer Disconnect	To Select To Verify	50 51	Double Beep	Enter Duration 0 – Off 1 – 10 sec. 2 – 20 sec. 3 – 30 sec. 4 – 40 sec. 5 – 50 sec. 6 – 60 sec.	Triple Beeps	30 Sec.

Computer Monitor

This option selects a device to be connected to the RS-232 port, a computer monitor for logging of all paging activity. The default setting is Computer Monitor.

Computer Monitor Mode

By selecting Computer Monitor (the default option), the PagePac Plus is enabled to monitor activity on Attendant Access, Telephone Interface, and Night Bell inputs. This feature requires that a PC computer be connected to the RS-232 port of the PagePac Plus Controller. Whenever the input becomes active, ASCII characters will be sent out the RS-232 port (DB9 pin connector) to the computer. The ASCII characters will be intercepted by a special software package in the computer that logs the time, date, input zone, type of activity, zone that was paged, and duration of the activity. All such input activity to the paging system can then be viewed (and recorded) on the computer.

NOTE: Since the default option is the ONLY option, there is no need to program this.

Programming Steps

First access the PagePac Plus system and enter the programming mode by pressing [*][*] and entering your Programming password (if optioned). You may exit the programming mode by dialing [#]. The default setting for this option is Computer Monitor.

1. Dial [5][2] to select this option.

Hear a DOUBLE beep.

2. Dial the code to activate this option:

[0] to select Computer Monitor

Hear TRIPLE beeps.

NOTE: For Zone or group zone level monitoring see the Zone Monitor section.

To verify the status of this option, dial [5][3] and repeat step 2 above.

These actions are summarized in table 2-9.

NOTE: If Computer Monitor has been connected and PagePac Plus software loaded, you will need to select the types of paging inputs to be displayed or recorded. See next programming option "Input Computer Monitor."

Table 2-9. Computer Monitor Option

Feature	Mode Option/Verify	Dial	Listen For	Choose Option	Listen For	Default
Computer Monitor	To Select To Verify	52 53	Double	0 – Computer Monitor	Triple Beeps	Computer Monitor

Input Computer Monitor

This option turns ON or OFF the inputs of Attendant Access, Telephone Access, and Night Bell to be recorded and displayed by the Computer Monitor if you have activated it in the preceding programming option.

The factory default is OFF for all three.

Programming Steps

First access the PagePac Plus system and enter the programming mode by pressing [*][*] and entering your Programming password (if optioned). You may exit the programming mode by dialing [#].

You will repeat this procedure 3 times in order to reset all three inputs.

1. Dial [5][4] to select this option.

Hear a DOUBLE beep.

2. Dial the code to select an option for one of the three inputs:

- [0] to turn OFF the Attendant Access
- [1] to turn ON the Attendant Access
- [2] to turn OFF the Telephone Access
- [3] to turn ON the Telephone Access
- [4] to turn OFF the Night Bell
- [5] to turn ON the Night Bell

Hear TRIPLE beeps.

To verify the status of this option, dial [5][5] and repeat step 2 above.

These actions are summarized in table 2-10.

Table 2-10. Inputs to Computer Monitor

Feature	Mode Option/ Verify	Dial	Listen For	Choose Option	Listen For	Default
Input Computer Monitor	To Select To Verify	54 55	Double Beep	0 – AA Off 1 – AA On 2 – T/R Off 3 – T/R On 4 – N.B. Off 5 – N.B. On	Triple Beeps	AA – Off T/R – Off N.B. – Off

General Zone Group Configurations Overview

General Zone and Zone Group Configurations are options that apply to selected zones or groups, not to the entire system. Refer to the Programming Quick Reference Chart for a summary of these options. The paragraphs following "Copy Command," describe each option and give programming instructions.

COPY Command

The COPY command can be used to copy the configuration of a zone that has already been optioned, to one or more additional zones. This saves recentering the same parameters over again, to duplicate the parameters of an existing zone. The digits [1] [2] are used as the COPY command.

First access the PagePac Plus system and enter the programming mode by pressing [*] [*] and entering your Programming password (if optioned). You may exit the programming mode by dialing [#].

1. Dial [1] [2] to activate COPY command.
Hear a DOUBLE beep tone.
2. Enter the zone number that you wish to copy (for example, 01).
Hear DOUBLE beep tone.
3. Enter the zone number of the beginning of the range of zones you wish to copy **to**. To copy the parameters of zone 01 to ALL other zones, the range zone 02 to 56 would be entered in this step and the next. To copy to a single zone (for example, 02) enter that zone number as both the beginning and the end of the range (02 to 02). in this step, enter only the beginning zone of the zone range.
Hear a DOUBLE beep tone.
4. Enter the zone number of the END of the zone range to be copied **to**. (See explanation in step 3.)
Hear a TRIPLE beep tone.

See table 2-11 for a summary of these actions.

Table 2-11. Copy Command

Copy Command	Dial 12	Double Beeps	Enter zone number that is to be copied.	Double Beeps	Enter the beginning of the range.	Double Beeps	Enter end of the range.	Triple Beeps
--------------	---------	--------------	-----------------------------------------	--------------	-----------------------------------	--------------	-------------------------	--------------

NOTES:

Program the PagePac Plus using the physical zone number
Exit the programming mode by dialing #

Zone Map Option—Assigning ALIAS Numbers

NOTE: Before doing this option, you **MUST** do "Define Length of ALIAS Numbers" above. (see table 2-2)

Zone Map permits you to assign the dialing code, called the ALIAS zone code, that you will dial to access a particular zone by telephone. The factory default is NONE: no ALIAS numbers are pre-programmed. The zones are identified by their 2-digit Physical Zone Codes – 01 thru 88- as the default condition.

Digit string length for an ALIAS code can be 2, 3 or 4 digits, but all ALIAS codes must have the same number of digits (see table 2-2 to set length). The [*] and [#] digits are not applicable digits for zone ALIAS numbers.

NOTE: If ALIAS numbers are enabled, you **MUST** use them for programming from now on.

Refer to your own Zone Map (table 1-2) and the Example Zone Map (table 1-1), in section 1.

Programming Steps

First access the PagePac Plus system and enter the programming mode by pressing [*][*] and entering your Programming password (if optioned). You may exit the programming mode by dialing [#].

1. Dial [*][*] to select this option.
Hear a DOUBLE beep.
2. Enter the 2-digit physical zone/group code, of the zone to be given an ALIAS number.
Hear a DOUBLE beep.
3. Enter the ALIAS zone/group number you have chosen. (Refer to your filled-in Zone Map, table 1-2.)
Hear TRIPLE beeps.

To verify the assignment of an ALIAS to a selected zone or group, dial [*][1] and repeat steps 2 and 3 above.

These actions are summarized in table 2-12.

Table 2-12. Zone Map Option: ALIAS Number Assignment

Feature	Mode Option/Verify	Dial	Listen For	Zone/Group Selection	Listen For	Choose Option	Listen For	Default
Zone Map	To Select To Verify	60 61	Double Beep	Enter physical zone/group number.	Double Beep	Enter alias zone/group number.	Triple Beeps	None

NOTES:

All zones/zone groups ALIAS codes must have the same number of digits. See table 2-2 to set length of ALIAS codes.

When an ALIAS number for a zone is changed, all the previous zone options for that zone will be transferred to the new zone number.

Type of Zone: Input or Output

NOTE: The INPUT #1 option must only be assigned to physical zones 1 through 8.

The choices here are INPUT #1, INPUT #2, and OUTPUT. Be sure the manually selectable Zone Option switch on the rear of the PagePac Plus Controller is set to match the type of zone selected (input or output). Input #1 would be used for an emergency alert, say a connection to your alarm system. Input #2 would be a lower priority, say a doorbell input. The factory default is OUTPUT (i.e., all zones are output type, by default).

Programming Steps

First access the PagePac Plus system and enter the programming mode by pressing [*] [*] and entering your Programming password (if optioned). You may exit the programming mode by dialing [#].

1. Dial [*] [*] to select this option.
Hear a DOUBLE beep.
2. Enter the number of the zone or zone group to be optioned. Use ALIAS numbers, if optioned. Otherwise, use Physical zone/group numbers.
Hear a DOUBLE beep.
3. Enter [0] to designate the zone as OUTPUT
Enter [1] to designate it as INPUT #1
Enter [2] to designate it as INPUT #2
Hear TRIPLE beeps.

To verify the zone type assignment, dial [*] [*] and repeat steps 2 and 3 above.

These actions are summarized in table 2-13.

Table 2-13. Type of Zone

Feature	Mode Option/Verify	Dial	Listen For	Zone/Group Selection	Listen For	Choose Option	Listen For	Default
Type of Zone	To Select To Verify	62 63	Double Beep	Enter zone/group number.	Double Beep	0 – Output 1 – Input 1 2 – Input 2	Triple Beeps	Output

Input Priority Arrangement

The input priorities are pre-set at the factory. You may only assign a priority level to inputs such as doorbell or security alarm, by assigning them to Input #1 or Input #2, which differ in priority.

NOTE: These priorities cannot be rearranged.

Also, if you select more than one zone to be inputs of the same level (Input 1, for example), such inputs will be handled on a first in, first served basis. See Type of Zone option, under General Zone / Group Configurations programming, later in this section.

The default setting is:

- 1 – Attendant Access
 - 2 – Input #1
 - 3 – Telephone Access
 - 4 – Input #2
 - 5 – Night Bell
- Music (always lowest priority)

Zone Monitor

This option selects a device to be connected to the RS-232 port, a computer monitor for logging of all zone or group zone paging activity. The default setting is off.

Computer Monitor Mode

By selecting Zone Monitor, the PagePac Plus is enabled to monitor activity on specific zone or group zone. This feature requires that a PC computer be connected to the RS-232 port of the PagePac Plus Controller. Whenever the input becomes active, ASCII characters will be sent out the RS-232 port to the monitor. The ASCII characters will be intercepted by a special software package in the computer that logs the time, date, input zone, type of activity, zone that was paged, and duration of the activity. All such input activity to the paging system can then be viewed (and recorded) on the computer.

Programming Steps

First access the PagePac Plus system and enter the programming mode by pressing [*][*] and entering your Programming password (if optioned). You may exit the programming mode by dialing [#]. The default setting for this option is Computer Monitor.

NOTE: For Zone or group zone level monitoring see the Zone Monitor section.

1. Dial [6] [6] to select this option.
Hear a DOUBLE beep.
2. Dial the code to activate this option:
[0] to select OFF

[1] to select ON.
Hear TRIPLE beeps.

To verify the status of this option, dial [6] [7] and repeat step 2 above.

These actions are summarized in table 2-14.

Table 2-14. Computer Monitor Option

Feature	Mode Option/Verify	Dial	Listen For	Zone/Group Selection	Choose Option	Listen For	Default
Computer Monitor	To Select To Verify	66 67	Double Beep	Enter zone or group number	0 - OFF 1 - ON	Triple Beeps	OFF

Zone Grouping

This option allows you to select a group of zones to be paged at the same time, The number of zone groups that can be formulated is eight; the maximum number of zones per group is 56 zones.

The factory default is NONE (there are no default zone groups).

Programming Steps

First access the PagePac Plus system and enter the programming mode by pressing [*] [*] and entering your Programming password (if optioned). You may exit the programming mode by dialing [#].

You will need to repeat this procedure for each zone group you wish to set up.

1. Dial [*] [*] to select this option.
Hear a DOUBLE beep.
2. Enter the zone code, of the zone group to be defined. For example, [*] [*] for group 80. Use ALIAS numbers, if optioned. Otherwise use Physical zone/group numbers.
Hear a DOUBLE beep.
3. Enter zone codes of zones to be included in the group. A # will terminate the string. For example, [*] [1] [(tone)], [*] [2] [(tone)], [1] [3] [(tone)], [1] [4] [(tone)], [#] indicates zones 1, 2, 13, and 14 are included in this group. Enter the codes consecutively, with no digit or character between them. Use ALIAS numbers, if optioned. Otherwise, use Physical zone/group numbers.
After entering a valid zone code, you will hear a confirmation tone, then a dial tone, and then you enter the next valid zone code or [#] to end the string.
Hear TRIPLE beeps.

To verify the zone group assignment, dial [*] [*] and repeat steps 2 and 3 above.

These actions are summarized in table 2-15.

Table 2-15. Zone Grouping

Feature	Mode Option/Verify	Dial	Listen For	Zone/Group Selection	Listen For	Choose Option	Listen For	Default
Zone Grouping	To Select To Verify	64 65	Double Beep	Enter group number.	Double Beep	Enter zone numbers. A # will terminate the string.	Triple Beeps	NONE

Output Zone/Group Confirmations Overview

These options apply to zones or groups already configured as outputs (see "Type of Zone," above). All these parameters can be individually optioned per zone. For a summary of these options, see the Programming Quick Reference Chart at the end of this section.

Type of Output

This option selects the type of output for an individual output zone. The choices here are AUDIO/NORMALLY OPEN, NORMALLY CLOSED, SYSTEM HANDSHAKE, MOMENTARY OPEN, and TOGGLE. The AUDIO/NORMALLY OPEN option is the default. The primary use for the NORMALLY CLOSED or SYSTEM HANDSHAKE is to determine how the switch closure is to function.

When the SYSTEM HANDSHAKE option is chosen, the closure will energize when a valid OFF HOOK condition has been detected. (System Handshake is a feature required by certain PBX systems: when they access the PagePac Plus, they require a return acknowledgment signal – the "handshake" – from the PagePac Plus.)

The MOMENTARY OPEN and TOGGLE options are intended to be used for controlling door striker plates, for instance, to permit a security door to be unlocked. The MOMENTARY OPEN will stay energized for as long as the zone is selected. The TOGGLE will stay energized until the zone is selected again. Neither of these modes will respond to an Attendant Access page or an All-Call page.

Programming Steps

First access the PagePac Plus system and enter the programming mode by pressing [*] [*] and entering your Programming password (if optioned). You may exit the programming mode by dialing [#].

You will need to repeat this procedure for each output zone.

1. Dial [z] [0] to select this option.

Hear a DOUBLE beep.

2. Enter the zone number, of the zone you wish to configure. Refer to your Zone Map (table 1-2). Use ALIAS numbers, if optioned. Otherwise, use Physical zone/group numbers.

Hear a DOUBLE beep.

3. Enter the code for the type of output you wish to select:

[0] selects AUDIO/N.O. (Normally Open)

[1] selects Momentary Open

[2] selects N/C (Normally Closed)

[3] selects Sys HS (System Handshake)

[4] selects Toggle

Hear TRIPLE beeps.

To verify the Type of Output assignment, dial [z] [1] and repeat steps 2 and 3 above.

These actions are summarized in table 2-16.

Table 2-16. Type of Output

Feature	Mode Option/ Verify	Dial	Listen For	Zone/Group Selection	Listen For	Choose Option	Listen For	Default
Type of Output	To Select To Verify	70 71	Double Beep	(Z)	Double Beep	0 – Audio/N.O. 1 – Mom.Open 2 – N-C 3 – Sys HS 4 – Toggle	Triple beeps	Audio/ N.O.

Page Enable

This output zone parameter enables paging for a selected output zone or zone group. The choice for this selection is YES/NO, with the default being YES. If you make an all-call page and this option is selected NO in either a Zone Group or Individual Zones, then an all-call page will be made to all other zones except the ones specified. If the decision is NO for the All-Call zone and an all-call page is made, then an error tone will be returned to you.

Programming Steps

First access the PagePac Plus system and enter the programming mode by pressing [*] [*] and entering your Programming password (if optioned). You may exit the programming mode by dialing [#].

You will need to repeat this procedure for each output zone or zone group.

1. Dial [*] [*] to select this option.
Hear a DOUBLE beep.
2. Enter the zone number, of the zone or group you wish to configure. Use ALIAS numbers, if optioned. Otherwise, use Physical zone/group numbers.
Hear a DOUBLE beep.
3. Enter [0] for NO (Page Not Enabled) or enter [1] for YES (Page enabled)
Hear TRIPLE beeps.

To verify the status of Page Enable for a given zone, dial [*] [*] and repeat steps 2 and 3 above.

These actions are summarized in table 2-17.

Table 2-17. Page Enable

Feature	Mode Option/ Verify	Dial	Listen For	Zone/Group Selection	Listen For	Choose Option	Listen For	Default
Page Enable	To Select To Verify	72 73	Double Beep	(Z,G)	Double Beep	0 – No 1 – Yes	Triple Beeps	Yes

Music Enable

This is an individual zone output parameter, that enables background music to be broadcast to a selected output zone (in the absence of a higher priority paging output). The choice is YES/NO, with the default being NO.

Programming Steps

First access the PagePac Plus system and enter the programming mode by pressing [*][*] and entering your Programming password (if optioned). You may exit the programming mode by dialing [#].

You will need to repeat this procedure for each output zone that you wish to have background music.

1. Dial [z][4] to select this option.
Hear a DOUBLE beep.
2. Enter the zone number, of the zone you wish to configure. Use ALIAS numbers, if optioned. Otherwise, use Physical zone/group numbers.
Hear a DOUBLE beep.
3. Enter [0] for NO (Music Not Enabled) or enter [1] for YES (Music enabled)
Hear TRIPLE beeps.

To verify the status of Music Enable for a given zone, dial [z][5] and repeat steps 2 and 3 above.

These actions are summarized in table 2-18.

Table 2-18. Music Enable

Feature	Mode Option/Verify	Dial	Listen For	Zone/Group Selection	Listen For	Choose Option	Listen For	Default
Music Enable	To Select To Verify	74 75	Double Beep	(Z)	Double Beep	0–No 1 – Yes	Triple Beeps	No

Talk-Back Enable

This is a zone output parameter that enables talk-back capability for a selected output zone or group. The choice is YES/NO, with the default being set to NO.

All speakers in a zone or group will be active 2-way speakers if talk-back has been enabled for a zone. See discussion of talk-back in the Application Notes, at the end of this guide.

Programming Steps

First access the PagePac Plus system and enter the programming mode by pressing [*] [*] and entering your Programming password (if optioned).

You will need to repeat this procedure for each output zone or zone group that you wish to have talk-back.

1. Dial [*] [*] to select this option.

Hear a DOUBLE beep.

2. Enter the zone number, of the zone or group you wish to configure. Use ALIAS numbers, if optioned. Otherwise, use Physical zone/group numbers.

Hear a DOUBLE beep.

3. Enter [0] for NO (Not Enabled) or enter [1] for YES (Enabled)

Hear TRIPLE beeps.

To verify the status of Talk-Back Enable for a given zone, dial [*] [*] and repeat steps 2 and 3 above.

These actions are summarized in table 2-19.

Table 2-19. Talk-Back Enable

Feature	Mode Option/ Verify	Dial	Listen For	Zone/Group Selection	Listen For	Choose Option	Listen For	Default
Talk-Back Enable	To Select To Verify	76 77	Double Beep	(Z,G)	Double Beep	0 – No 1 – Yes	Triple Beeps	No

Night Bell Enable

This is an individual zone output parameter. The choice is YES/NO with the default being NO. With this parameter set to YES, night bell will be sent to selected outputs whenever ring voltage is present on the night bell input (from the PBX to the controller).

If a closure is required to trigger the night bell, then a zone will need to be configured as an input to send night bell to designated zones when a closure is present. This is discussed in Tone Selection and Tone Routing, below.

Programming Steps

First access the PagePac Plus system and enter the programming mode by pressing [*][*] and entering your Programming password (if optional). You may exit the programming mode by dialing [#].

You will need to repeat this procedure for each output zone that you wish to receive the night bell signal.

1. Dial [z][*] to select this option.

Hear a DOUBLE beep.

2. Enter the zone number, of the zone you wish to configure. Use ALIAS numbers, if optional. Otherwise, use Physical zone/group numbers.

Hear a DOUBLE beep.

3. Enter [0] for NO (Not Enabled) or enter [1] for YES (Enabled)

Hear TRIPLE beeps.

to verify the status of Night Bell Enable for a given zone, dial [z][*] and repeat steps 2 and 3 above.

These actions are summarized in table 2-20.

Table 2-20. Night Bell Enable

Feature	Mode Option/ Verify	Dial	Listen For	Zone/Group Selection	Listen For	Choose Option	Listen For	Default
Night-Bell Enable	To Select To Verify	78 79	Double Beep	(Z)	Double Beep	0 – No 1 – Yes	Triple Beeps	NO

Pass DTMF to the Output

This zone output option enables the Touchtone telephone keypad tones (DTMF) to be passed through the PagePac Plus Controller and output to a second controller or other ancillary device.

NO Option

The choice is YES/NO, with the default being NO. Operating the unit in the default mode, you may switch from zone to zone (within the same PagePac Plus Controller) without hanging up, simply by dialing the zone number of the zone you wish to switch to. The DTMF tones you dial will be muted (not sent out as audio) as soon as they are detected by the controller.

NOTE: If you leave NO in option mode, you may page zone to zone without exiting system. System is locked up while you roam zone to zone.

Access to the first zone will be disconnected and you will hear a pre-announcement tone when the zone switch has been accomplished (if pre-announcement tone has been enabled).

YES Option

When you have accessed a zone with this parameter set to YES, DTMF will be sent out as un-muted audio but the PagePac Plus Controller will not respond to the DTMF tones (and will not switch zones).

NOTE: If you access a zone that is enabled for passing DTMF, you will not be able to switch to another zone (on the same controller) except by hanging up and re-initializing access to the PagePac Plus system.

This YES option, with DTMF tones enabled to the output, is useful when you have more than one PagePac Plus Controller daisy-chained in a system. The un-muted DTMF tone is passed through the first controller (not triggering a zone change) to the second controller (or other ancillary device), where it DOES activate a zone.

Programming Steps

First access the PagePac Plus system and enter the programming mode by pressing [*] [*] and entering your Programming password (if optioned). You may exit the programming mode by dialing [#].

You will need to repeat this procedure for each output zone or zone group that you wish to receive the DTMF tones.

1. Dial [*] [*] to select this option.

Hear a DOUBLE beep.

2. Enter the zone number, of the zone or group you wish to configure to receive the DTMF. Use ALIAS numbers, if optioned. Otherwise, use Physical zone/group numbers.

Hear a DOUBLE beep.

3. Enter [*] or NO (Not pass DTMF) or enter [1] for YES (Pass DTMF)

Hear TRIPLE beeps.

To verify the status of DTMF Pass for a given zone, dial [*] [1] and repeat steps 2 and 3 above.

These actions are summarized in table 2-21.

Table 2-21. Pass DTMF to the Output

Feature	Mode Option/ Verify	Dial	Listen For	Zone/Group Selection	Listen For	Choose Option	Listen For	Default
Pass DTMF to the Output	To Select To Verify	90 91	Double Beep	(Z,G)	Double Beep	0 – No 1 – Yes	Triple Beeps	No

Input Zone / Group Options Overview

These options apply to zones or groups already configured as inputs (see "Type of Zone," above). These options are summarized in the Programming Quick Reference Chart, at the end of this section.

Tone Selection

This is called "Activate Tone via an Input Closure," on the Quick Reference Chart.

If a zone is configured to be an input and is activated, then a tone may be selected to be directed to whatever zone(s) are selected in "Tone Routing," below. The tone may be either Night Bell, Chime, Double Chime, Siren, or Gong.

For example, you wish to have a doorbell pushbutton input cause a chime to be heard in certain zones. You have already configured the zone of the doorbell as an input zone (table 2-12). You need to select the tone (chime) you wish to be heard in the output zones, when the doorbell is pressed.

The default setting for this option is NONE (not activated).

Programming Steps

First access the PagePac Plus system and enter the programming mode by pressing [*] [*] and entering your Programming password (if optioned). You may exit the programming mode by dialing [#].

1. Dial [*] [*] to select this mode option.

Hear a DOUBLE beep.

2. Enter the number of the input zone (the zone containing the doorbell pushbutton). Use ALIAS numbers, if optioned. Otherwise, use Physical zone/group numbers.

Hear a DOUBLE beep.

3. Enter the tone option, 0 through 7.

[0] None
[1] Chime
[2] Siren
[3] Warble Siren
[4] Night Bell
[5] Fast Ring
[6] Steady Tone
[7] Door Bell

Hear TRIPLE beeps.

To verify the tone option for a given input zone, dial [9] [3] and repeat steps 2 and 3 above.

These actions are summarized in table 2-22. The different tones are described below.

Table 2-22. Tone Selecting

Feature	Mode Option/ Verify	Dial	Listen For	Zone/Group Selection	Listen For	Choose Option	Listen For	Default
Activate Tone via an Input Closure	To Select To Verify	92 93	Double Beep	Enter the input zone number.	Double Beep	0 – None 1 – Chime 2 – Siren 3 – Warble Siren 4 – Night Bell 5 – Fast Ring 6 – Steady Tone 7 – Door Bell		

Description of Tones

Dial tone: continuous, like the dial tone of a telephone system

Confirmation tone: three beeps

Pre-Announcement tone: 1.5 second duration, 440 Hz

Talk-back Warning tone: 1.5 second duration, 440 Hz

Programming Ready tone: same as dial tone

Programming/Access Confirmation tone: two beeps

Programming/Access Error tone: beep-hoop, beep-hoop, repeating

Override tone: similar to a "busy signal" on a telephone

Night Bell tone: fast ding-a-ling

Chime: constant period with a sweeping duty cycle

Warble Siren: sweep frequencies up and down

Fast Ring: fast electronic ringer

Steady Tone: steady tone

Door Bell: ding-dong

Tone Routing

Whatever zones are selected here will receive the tone selected in the previous option, "Tone Selection."

For example, you have optioned an input zone to receive a doorbell pushbutton input. And you have selected a tone (in the previous step) to be output when the doorbell input is received. Now you must select the output zone or zone group which will receive the tone.

Programming Steps

First access the PagePac Plus system and enter the programming mode by pressing [*] [*] and entering your Programming password (if optioned). You may exit the programming mode by dialing [#].

1. Dial [9] [4] to activate Tone Routing.
Hear a DOUBLE beep.
2. Enter the input zone number. Use ALIAS numbers, if optioned. Otherwise, use Physical zone/group numbers.
Hear a DOUBLE beep.
3. Enter the output zone/group ALIAS number.
Hear TRIPLE beeps.

To verify Tone Routing, dial [9] [5] and repeat steps 2 and 3 above.

Table 2-23 summarizes these actions.

Table 2-23. Tone Routing

Feature	Mode Option/Verify	Dial	Listen For	Zone/Group Selection	Listen For	Choose Option	Listen For	Default
Tone Routing	To Select To Verify	94 95	Double Beep	Enter the input zone number	Double Beep	Output zone/group number	Triple Beeps	None

Audio Source Enable

The primary use for this feature is to allow the PagePac Plus to be used for door service. If optioned, whenever a selected zone is active (i.e., the doorbell pushbutton), an audio source (either Telephone Access or Attendant Access) will be routed automatically to a zone (the door speaker-phone) selected in "Audio Routing," below. The default for this option is NONE.

Programming Steps

First access the PagePac Plus system and enter the programming mode by pressing [*] [*] and entering your Programming password (if optioned). You may exit the programming mode by dialing [#].

1. Dial [9] [6] to select Audio Source Enable.
Hear a DOUBLE beep.
2. Enter the input zone number. Use ALIAS numbers, if optioned. Otherwise, use Physical zone/group numbers.
Hear a DOUBLE beep.
3. Enter [0] (NONE), [1] (AA, Attendant Access), or [2] (T/R, Telephone Access) to select the audio source (or none) to be enabled when this zone is activated.
Hear TRIPLE beeps.

To verify your selection, Dial [9] [7] and repeat steps 2 and 3, above.

Table 2-24 summarizes the Audio Source Enable options.

Table 2-24. Audio Source Enable

Feature	Mode Option/ Verify	Dial	Listen For	Zone/Group Selection	Listen For	Choose Option	Listen For	Default
Audio Source Enabled	To Select To Verify	96 97	Double Beeps	Enter the input zone number	Double Beeps	0 - None 1 - AA 2 - T/R	Triple Beeps	None

Audio Routing

If optioned, whenever a selected input zone with "Audio Source Enabled" is active, the audio source (either Telephone Access or Attendant Access) will be routed to the selected zone or group. The default for this parameter is NO ZONES.

Door Service

The primary use for this feature is to allow the PagePac Plus to be used for door service. For example, you have optioned the doorbell input zone to enable Telephone Access, and you wish now to select the door speaker to be the output zone for this Telephone Access audio.

The audio path will remain routed for 10 seconds. If the user accesses the controller during the 10 second period, they will automatically be routed to the zone specified in this procedure. If the user accesses the controller after the time expires, the user will receive a dial tone.

If a Connect password has been installed in your system, you will have to access the PagePac Plus and enter your password, before being automatically routed to the zone..

If the doorbell input has a higher priority than the telephone access and is activated while telephone access paging is underway, then you will receive the tone specified in the option "Tone Selection," above, and then will be automatically routed to the proper zone.

Programming Steps

First access the PagePac Plus system and enter the programming mode by pressing [*][*] and entering your Programming password (if optioned). You may exit the programming mode by dialing [#].

1 . Dial [9] [9] to select Audio Routing.

Hear DOUBLE beeps.

2 . Enter the input zone number. Use ALIAS numbers, if optioned. Otherwise, use Physical zone/group numbers.

Hear DOUBLE beeps.

3 . Enter the output zone / group ALIAS number.

Hear TRIPLE beeps.

To verify your selection, dial [9] [9] and repeat steps 2 and 3 above.

Table 2-25 summarizes the Audio Routing actions.

Table 2-25. Audio Routing

Feature	Mode Option/ Verify	Dial	Listen For	Zone/Group Selection	Listen For	Choose Option	Listen For	Default
Audio Routing	To Select To Verify	98 99	Double Beep	Enter the input zone number.	Double Beep	Output zone/ group number.	Triple Beeps	None

Error Tones

The Error Tone is heard over the phone receiver when an incorrect zone number has been dialed or contradictory programming input has been attempted.

Hear error tone when dialing a zone ALIAS number

When a zone is selected by Touchtone telephone keypad input (DTMF), the PagePac Plus searches for the zone in numerical order of the physical zones; the value dialed (the ALIAS number) is then compared to the digits stored in memory for each physical zone. If not found, then an error tone will be returned to the user. Refer to your Zone Map (table 1-2) to review your ALIAS number assignments, and see table 2-12 to review of the Zone Map Option programming steps.

Error tone received when programming a zone or group

If ever there is a conflict in the programming options between a zone and a group to which it is assigned (i.e., zone 1 is optioned as an input as an individual zone, but is optioned as an audio output as part of a zone group), then an error tone will be returned to the user's receiver.

Zone group configurations will override individual zone configurations whenever a zone group is selected. Refer to your filled-in Zone Map (table 1-2) and Zone Configuration Tables (1-3 and 1-4) to identify any conflict, and refer to table 2-13 for programming steps to reprogram the erroneous zone.

Programming Quick Reference Chart

To Enter the Programming Mode

- (1) dial the PagePac Plus system access extension
- (2) enter the connect password (if any)
- (3) press [*][*] and enter your programming password (if optioned)

Chart 1. System Configuration Options

Feature	Mode Option/ Verify	Dial	Listen For	Choose Option	Listen For	Default
Reset to Factory Defaults	To Select	10	Double Beep	Enter 25327 to reset. Enter any invalid number string to escape.	Triple Beeps	25327 (CLEAR)
Number of Zone Map Digits	To Select To Verify	20 21	Double Beep	2 (digits) 3 (digits) 4 (digits)	Triple Beeps	2
Connect Password	To Select To Verify	30 31	Double Beep	Enter Password, enter # to terminate the string.	Triple Beeps	None
Programming Password	To Select To Verify	32 33	Double Beep	Enter Password, enter # to terminate the string.	Triple Beeps	* *
Confirmation Tone	To Select To Verify	40 41	Double Beep	0 – Off 1 – On	Triple Beeps	On
Pre-Announcement Tone	To Select To Verify	42 43	Double Beep	0 – Off 1 – On	Triple Beeps	On
Talk-back Warning Tones	To Select To Verify	44 45	Double Beep	0–Off 1 – Initial 2 – Initial and 30 sec.	Triple Beeps	Initial and 30 sec.
VOX Timer Disconnect	To Select To Verify	50 51	Double Beep	Enter Duration 0 – Off 1 – 10 sec. 2 – 20 sec. 3 – 30 sec. 4 – 40 sec. 5 – 50 sec. 6 – 60 sec.	Triple Beeps	30 Sec.
Computer Monitor	To Select To Verify	52 53	Double Beep	0 – Computer Monitor	Triple Beeps	Computer Monitor
Input Computer Monitor	To Select To Verify	54 55	Double Beep	0 – AA Off 1 – AA On 2 – T/R Off 3 – T/R On 4 – N.B. Off 5 – N.B. On	Triple Beeps	AA – Off T/R – Off N.B. – Off

NOTES:

Exit the programming mode by dialing #
The # key will terminate a digit string (i.e., Password string)

Chart 2. General Zone / Group Configurations

Feature	Mode Option/ Verify	Dial	Listen For	Zone/Group Selection	Listen For	Choose Option	Listen For	Default
Zone Map	To Select To Verify	60 61	Double Beep	Enter physical zone/group number.	Double Beep	Enter alias zone/group number.	Triple Beeps	None
Type of Zone	To Select To Verify	62 63	Double Beep	Enter zone/group number.	Double Beep	0 - Output 1 - Input 1 2 - Input 2	Triple Beeps	Output
Zone Grouping	To Select To Verify	64 65	Double Beep	Enter group number.	Double Beep	Enter zone numbers. A # will terminate the string.	Triple Beeps	None
Computer Monitor	To Select To Verify	66 67	Double Beep	Enter zone or group number	Double Beep	0 – OFF 1 – ON	Triple Beeps	OFF

NOTES:

When a Zone Map number (ALIAS) is changed, all of the previous options for that zone will be transferred to the new zone number

Program the PagePac Plus using ALIAS numbers, if optioned. Otherwise, use Physical zone/group numbers

Exit the programming mode by dialing #

The # key will terminate a digit string (i.e. Zone Numbers string)

Chart 3. Output Zone / Group Configurations

Feature	Mode Option/ Verify	Dial	Listen For	Zone/Group Selection	Listen For	Choose Option	Listen For	Default
Type of Output	To Select To Verify	70 71	Double Beep	(Z)	Double Beep	0 – Audio/N.O. 1 – Mom. Open 2 – N/C 3 – Sys HS 4 – Toggle	Triple Beeps	Audio/ N.O
Page Enable	To Select To Verify	72 73	Double Beep	(Z,G)	Double Beep	0 – No 1 – Yes	Triple Beeps	Yes
Music Enable	To Select To Verify	74 75	Double Beep	(Z)	Double Beep	0 – No 1 – Yes	Triple Beeps	No
Talk-Back Enable	To Select To Verify	76 77	Double Beep	(Z,G)	Double Beep	0 – No 1 – Yes	Triple Beeps	No
Night-Bell Enable	To Select To Verify	78 79	Double Beep	(Z)	Double Beep	0 – No 1 – Yes	Triple Beeps	No
Pass DTMF to the Output/	To Select To Verify	90 91	Double Beep	(Z,G)	Double Beep	0 – No 1 – Yes	Triple Beeps	No

NOTES:

Z = select Individual Zone

G = select Zone Group (including All Call group)

Program the PagePac Plus using ALIAS numbers, if optional. Otherwise, use Physical zone/group numbers

Exit the programming mode by dialing #

Chart 4. Input Zone / Group Configurations

Feature	Mode Option/ Verify	Dial	Listen For	Zone/Group Selection	Listen For	Choose Option	Listen For	Default
Activate Tone via an Input Closure	To Select To Verify	92 93	Double Beep	Enter the input zone number.	Double Beep	0 – None 1 – Chime 2 – Siren 3 – Warble Siren 4 – Night Bell 5 – Fast Ring 6 – Steady Tone 7 – Door Bell	Triple Beeps	None
Tone Routing	To Select To Verify	94 95	Double Beep	Enter the input zone number.	Double Beep	Output zone/group number	Triple Beeps	None
Audio Source Enabled	To Select To Verify	96 97	Double Beep	Enter the input zone number.	Double Beep	0 – None 1 – AA 2 – T/R	Triple Beeps	None
Audio Routing	To Select To Verify	98 99	Double Beep	Enter the input zone number.	Double Beep	Output zone/group number	Triple Beeps	None

NOTES:

Program the PagePac Plus using the ALIAS numbers, if optioned. Otherwise, use Physical zone/group numbers

Exit the programming mode by dialing #

The # key will terminate a digit string (i.e. Zone Numbers string)

The Copy Command

Copy Command	Dial 12	Double Beeps	Enter zone number that is to be copied.	Double Beeps	Enter the beginning of the range.	Double Beeps	Enter end of the range.	Triple Beeps
-----------------	---------	-----------------	-----------------------------------------------	-----------------	-----------------------------------------	-----------------	----------------------------	-----------------

3

Contents

Power Up	3-2
System Administrator	3-2
End User	3-2
■ Using Telephone to Make a Voice Page	3-2
■ Using Telephone to Respond to Doorbell Tone	3-3
User Quick Reference Card	3-4

Power UP

When the PagePal Plus Controller is first powered up, it polls the zones to determine how many (if any) zone expansion modules are present. (The Controller has the ability to serially access Up to 48 external zones.)

System Administrator

Enter Programming Mode

To enter the programming mode, first access the paging system by dialing its proper extension or trunk, then dial the Connect password (if one has been activated), then dial the Programming password (if one has been vated) and always dial [*] [*] to enter programming mode. Refer to the programming details (section 2) or to the Programming Quick Reference Chart for instructions to program the PagePac Plus Controller.

Connect Password

To institute a Connect password, refer to programming steps for "Connect Password" in section 2.

Programming Password

To institute a Programming password, refer to programming steps for "Programming Password" in section 2.

For specific examples of PagePac Plus applications, see the Application Notes, following this section.

End User

Using Telephone to Make a Voice Page

NOTE: If the wrong password is entered, you will lose the dial tone. Hang up and start again.

NOTE: The pound sign (#) takes you back one step (to the dial tone, in this case) so that if you entered the wrong zone code, you can back out of it and reenter the correct code.

1. Dial the paging system extension or trunk. Hear system dial tone.
2. Enter the Connect password (if one has been established). Hear confirmation tone.
3. Dial the zone code. (Refer to the Quick Reference Card.) Hear confirmation tone.
4. Speak your paging message.
5. (Optional) If you wish to transfer to a different paging zone (while you are already active in a zone), simply dial the extension of the other zone, without hanging up. You will hear a tone confirming you have accessed the other zone.

Using Telephone to Respond to Doorbell Tone

Within 10 Seconds

If you pick up your telephone and access the paging system within 10 seconds of the sounding of the doorbell tone, the paging system will automatically route your voice to the door speaker at the door. You need not dial a zone code. However, if a Connect password has been installed in your system, you will need to access the PagePac Plus and enter the password before being routed to the door speaker.

After 10 Seconds

If 10 seconds has elapsed before you access the paging system, you will hear a dial tone, and need to enter a zone code to reach the door speaker, in order to talk to the person who rang the doorbell.

If you have more than one security door equipped with doorbell and/or door speaker, you will want to configure a group zone for audio output (with talk-back) to the door speakers, so that you can page all of them at once, in order to ask the visitor to identify the door he is at. Then you can dial the code for the speaker phone at that door, in order to speak further to him, or dial the door control code to unlock that door.

Unlock the Door

If the door is equipped with a locking device that has been connected to the PagePac Plus system, you can use your telephone to unlock it and permit the door to open.

If you are still talking to the person at the door via the telephone paging system:

- Dial the zone code of the door lock mechanism, to send the unlock signal.

If you are NOT currently engaging the paging system via your telephone:

- Dial the paging extension or trunk.
Hear dial tone.
- Enter the Connect password (if any). Hear Confirmation tone.
- Enter the zone code for triggering the door to unlock.

User Quick Reference Card

Remove the blank User Quick Reference Card (opposite page) and fill it out to reflect your paging system. Make copies and distribute to all users.

This page provides an example of a filled-out card.

PAGING SYSTEM QUICK REFERENCE CARD (Example)

- Paging System Access by Telephone
- (1) Dial the PagePac Plus system access extension.
 - (2) Enter the Connect password (if any).
 - (3) Dial the code for the zone or zone group to be paged (see table below).
 - (4) To leave one zone and go directly to another, just dial the code for the other zone (don't hang up).

Paging Zones

Description of Zone	Zone Dial Code	Notes
Front Office Area	201	Voice Paging
Warehouse Area	202	Voice Paging with Talk-back
Shipping/Receiving Area	203	Voice Paging with Talk-back
Door, S/R Dock, Speaker	305	Intercom
Door Lock: Security Door, S/R Dock	306	Unlocks door until you hang up
Garage Area	401	Voice Paging
All Call: All paging areas	555	Voice Paging to All Areas
Combined Warehouse / Shipping Areas	557	Voice Paging to Warehouse, Shipping

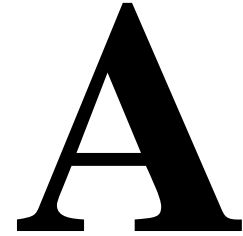

Application Notes

Night Bell

There are two different Night Bell connections possible with the PagePac Plus Controller. These are illustrated in figure A-1.

From an EKTS Telephone System

A programmer needs to know what type of Night Bell connection exists between the telephone system and the PagePac Plus. In one case, typically with an EKTS telephone system, where Night Bell input is wired to one of the eight PagePac Plus onboard zones (one of the eight onboard zones corresponding to the eight switches on the rear of the controller), then you will need to configure it as an input zone, just as any other (door bell, alarm system, door ajar, etc.). See tables 2-13, 2-21, and 2-22 in section 2 for programming instructions.

From a PBX or Centrex System

In the other case, typically with a PBX system that produces a ring voltage output, the Night Bell connection is *not* wired to one of the eight input zones, but to another connector on the rear of the PagePac Plus (see *Installation Guide*).

You will want to enable the Night Bell tone, whenever this input is received, and route it to selected zones. Refer to table 2-19 in section 2 for programming instructions.

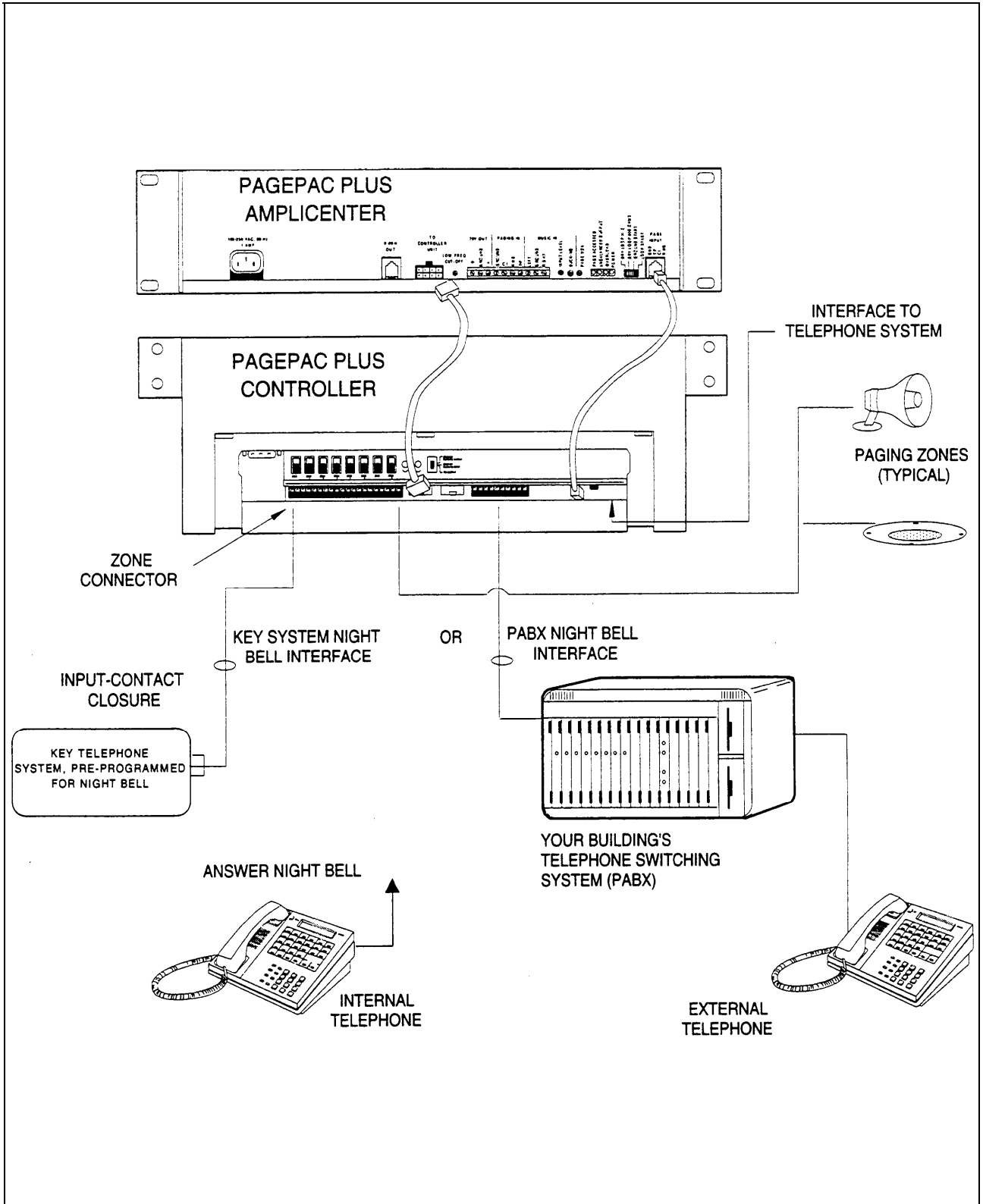

Figure A-1. Night Bell Interfaces

Background Music

Is a music source connected to your PagePac Plus Amplicenter? Which zones do you wish background music to be heard in? You can adjust the music volume level, ducking level, bass level, and voice volume level (for voice paging) on the PagePac Plus Amplicenter.

Figure A-2 illustrates typical music interfaces to the PagePac Plus system.

For programming information to enable music, see table 2-17 in section 2.

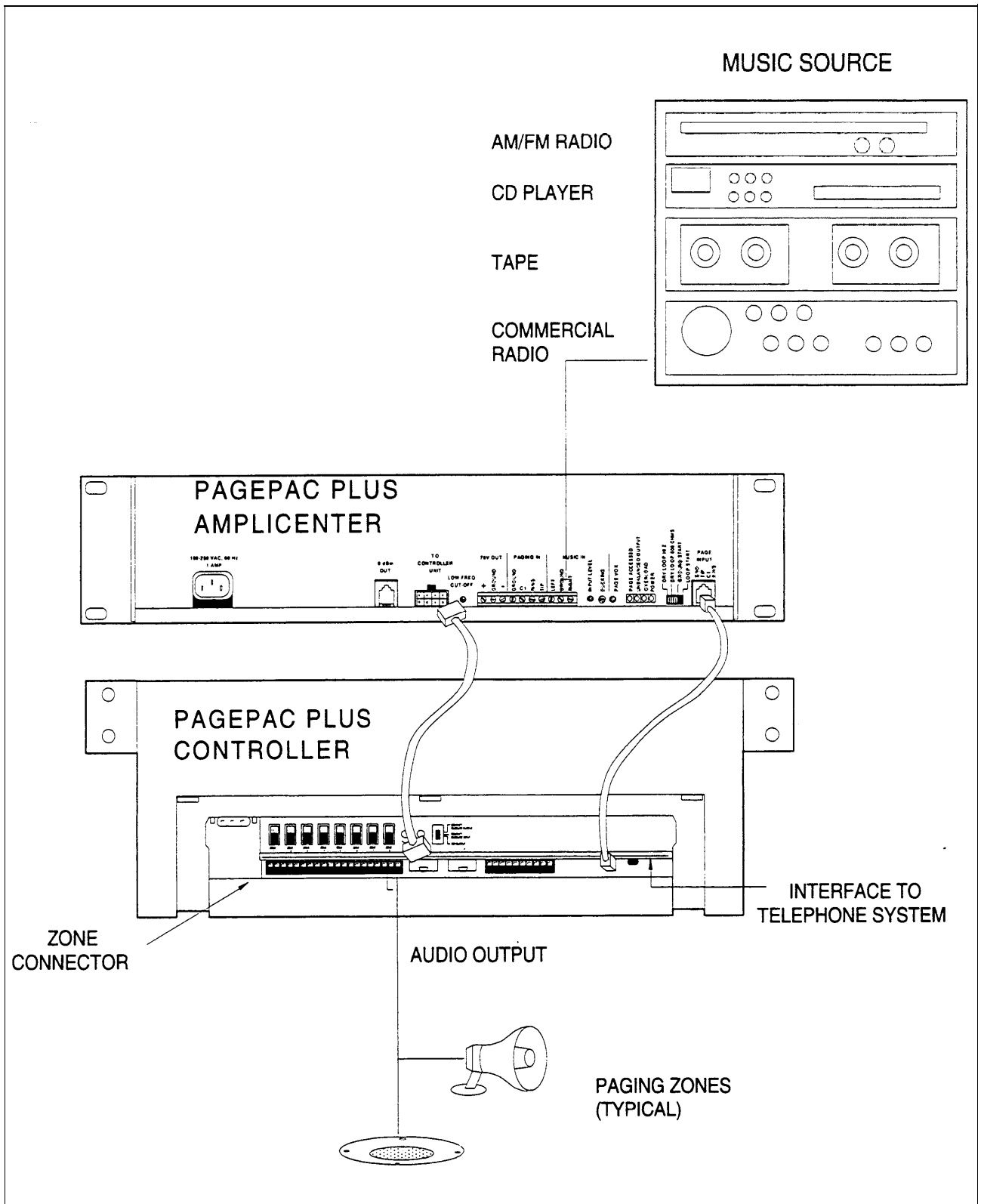

Figure A-2. Music Interfaces

Door Control

Visitor Presses Doorbell

Figure A-3 illustrates door control interfaces.

When a visitor presses the doorbell of a security door, a contact-closure input to the controller signals an output tone (i.e., a door chime) to selected paging zone(s).

Programming information is provided in section 2, table 2-13 to interface the doorbell as an input zone, 2-21 to select a tone to be sounded when the doorbell input is activated, 2-22 to route the tone to in-facility paging zones.

It should also be optioned for "Audio Enable" so that it automatically opens an audio channel between the door speaker and your telephone access (or attendant access). Refer to table 2-23 to enable audio when the doorbell is pressed.

Answering the Doorbell

The person inside the building, having heard the door chime, can simply dial the PagePac Plus extension and establish two-way communications with the door speaker.

If the input zone (door bell) has been optioned for Audio Enable, then the user's telephone access (or attendant access, depending on the option chosen in Audio Enable) connects via the paging system to the door speaker, for a period of 10 seconds. If the user doesn't pick up the phone until after the 10 seconds has passed, he must dial the Door Speaker zone code to talk.

If the doorbell input has a higher priority than T/A (i.e., is Input #1), and is activated while T/A paging is in progress, or during a dial tone, then the user will hear the door chime tone and be automatically routed to the door speaker for two-way communication.

Programming information is provided in section 2, table 2-13 to interface the door speaker-phone as an output zone, table 2-15 to configure the , type of output for the door speaker-phone, table 2-16 to enable page for the door speaker, table 2-18 to enable talk-back for the door speaker, and table 2-24 to route the telephone access audio to the door speaker-phone.

Door Unlock

NOTE: The door ajar switch, if any, should be programmed similarly to a doorbell as an input zone, resulting in a tone.

The person inside the building can also remotely unlock the door, by entering a numeric code (Door Code) on the telephone's keypad.

Programming information is provided in section 2, table 2-13 to interface the door lock device as an output zone (momentary normally-open switch), and table 2-15 to configure the type of output for the door lock device output.

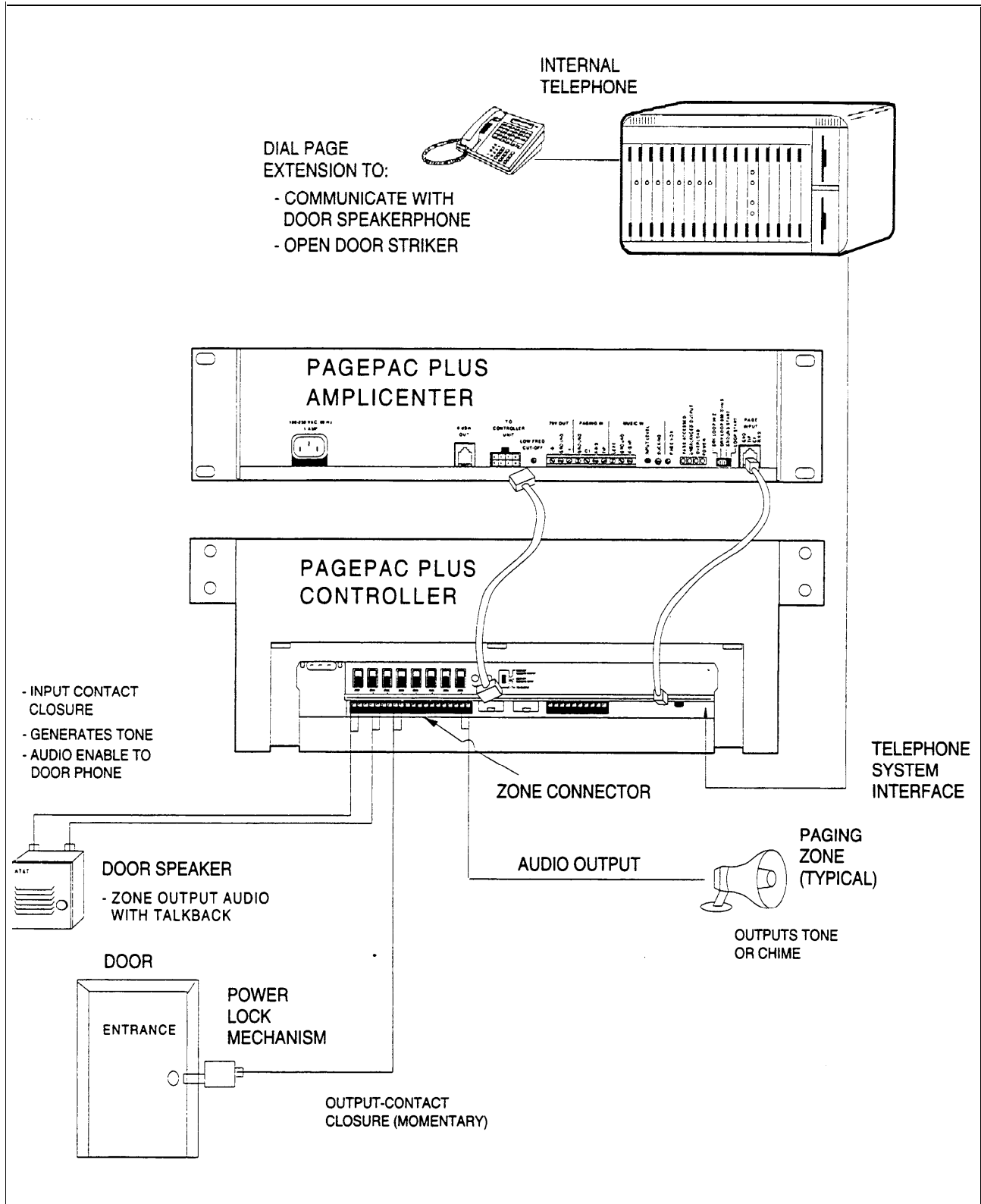

Figure A-3. Door Control Interfaces

Alarm System Input

Figure A-4 illustrates a typical alarm system interface.

Program the alarm system input as a contact-closure input, resulting in a warning tone output to all zones (or selected zones only).

Refer to section 2 for programming steps, in table 2-13 to set the alarm system interface as an input zone, table 2-21 to select a tone to be triggered, and table 2-22 to route the warning tone to paging zones.

Talkback

All speakers in a zone will be two-way speakers, if talkback has been enabled for a zone. Therefore all speakers in the talkback zone will pick up ambient noise, as well as the voices of persons addressing the paging speakers.

It is not recommended to have more than two speakers in a zone that is designated for talkback. However, there are situations where it is desirable to have more talkback speakers in a zone. For example, a security guard may want to listen to sounds throughout a restricted area containing several dozen talkback speakers, which would be configured as a single zone. See the *Installation Guide* for details about speaker connections.

See table 2-18 in section 2 for programming details. Figure A-5 illustrates talk-back in the PagePac Plus system.

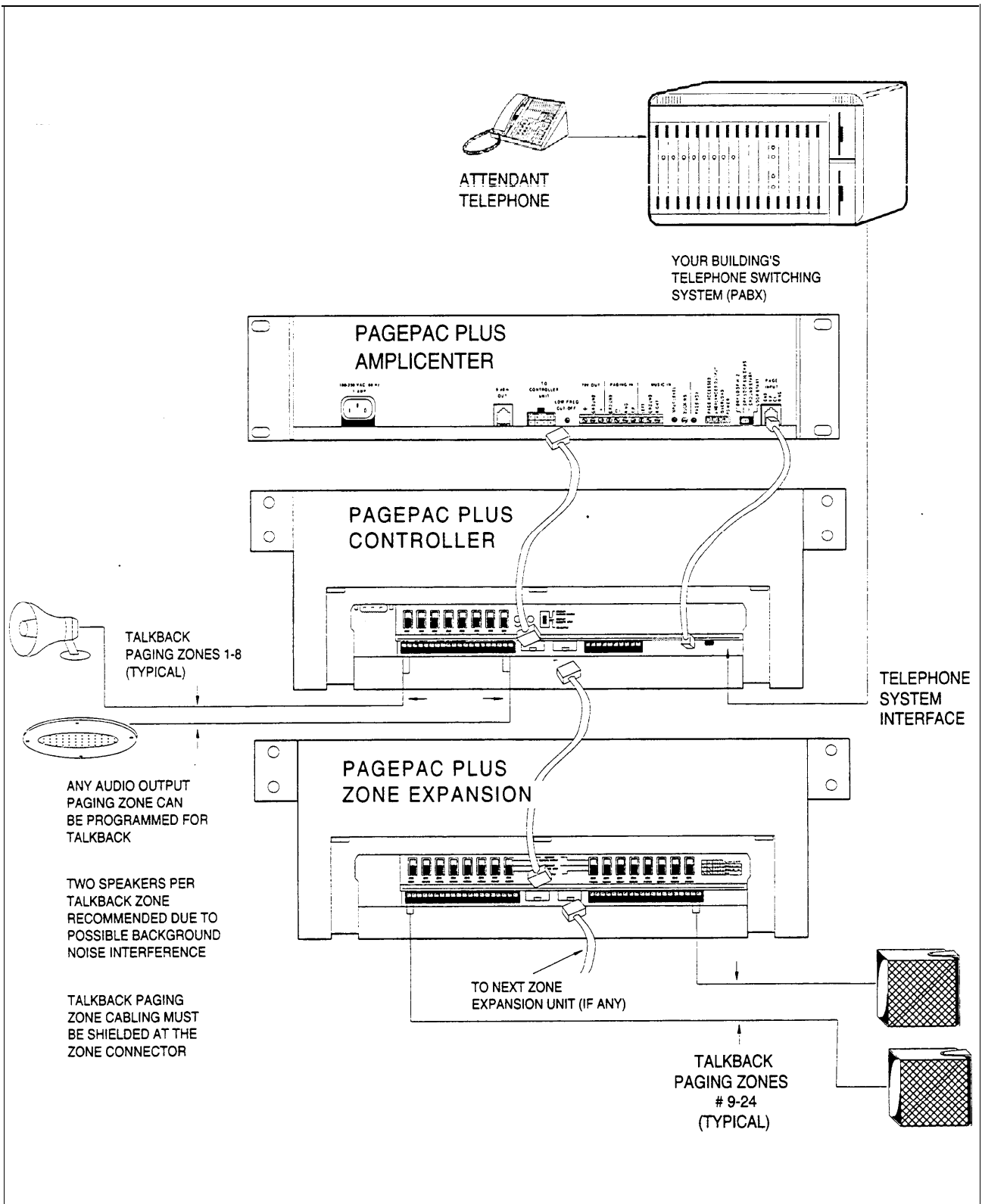

Figure A-5. System with Talk-Back

Computer Monitor Paging Log

Is a PC computer connected to the RS-232 port of the PagePac Plus Controller for the purpose of logging paging activities? If so, you will want to program the controller to send signals to it, and turn ON/OFF the Attendant Access, Telephone Access, and Night Bell signals that would trigger the monitor to log the event.

Figure A-6 shows a typical computer monitor interface for logging purposes.

For programming information, see section 2 table 2-9 to select the computer monitor option, and table 2-10 to select default inputs to the monitor.

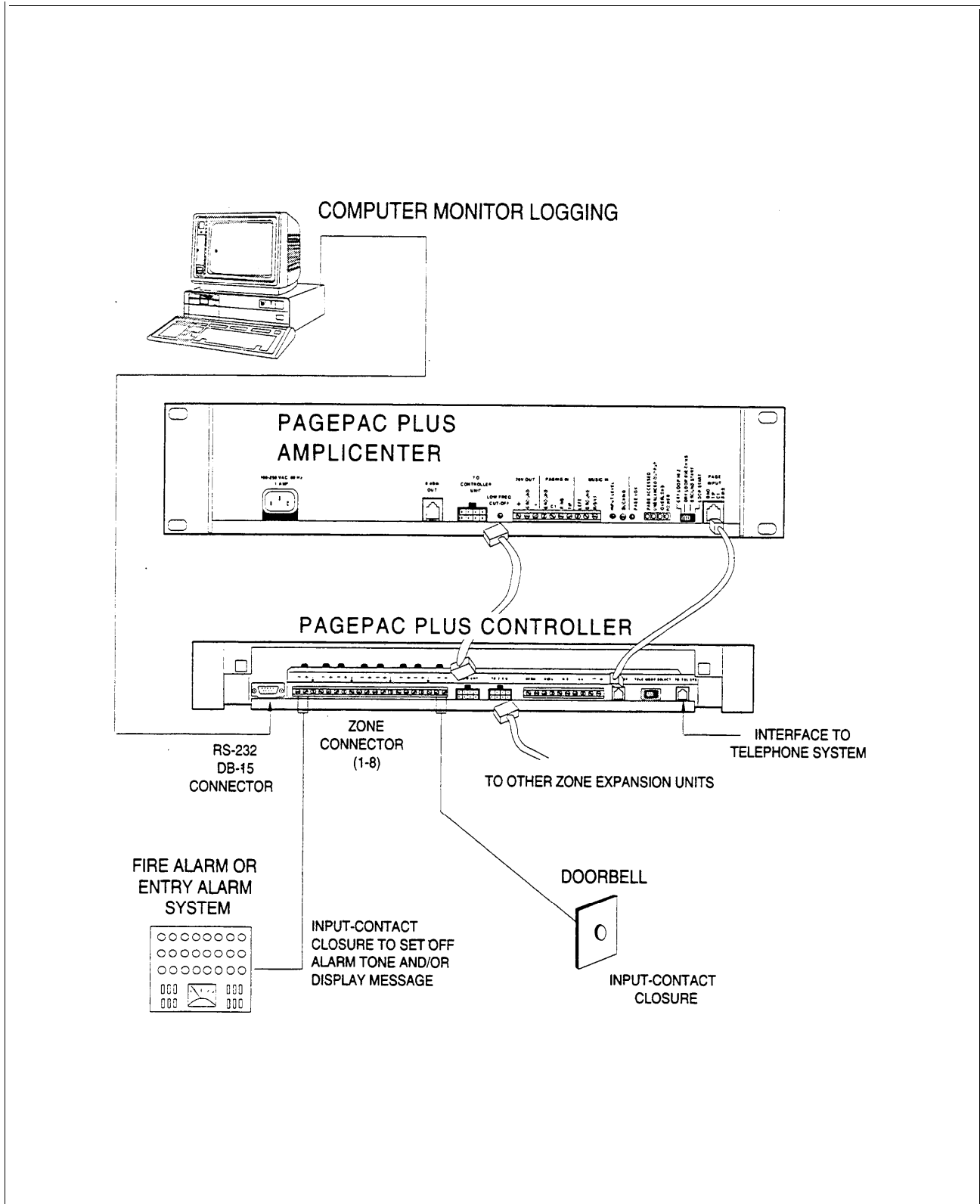

Figure A-6. Computer Monitor Logging Interface

Connecting Additional PagePac Plus Controllers or Remote Amplifiers

When additional PagePac Plus Controller(s) or other ancillary devices are daisy-chained with the first PagePac Plus Controller, you will want to ensure that the programming option DTMF Enabled to the Output has been selected for a YES condition for output zones. This permits you, when engaged in paging by telephone in one zone, to dial another zone number (residing on the remote PagePac Plus unit) and automatically reach that zone. Your DTMF dial input tones are passed through the first (main) PagePac Plus Controller, to the second one, where a switch of zones occurs in response to the dialed tones.

See table 2-20 in section 2, for programming steps to enable DTMF pass-through.

Figure A-7 illustrates a PagePac Plus system with an additional controller unit and remote amplifier.

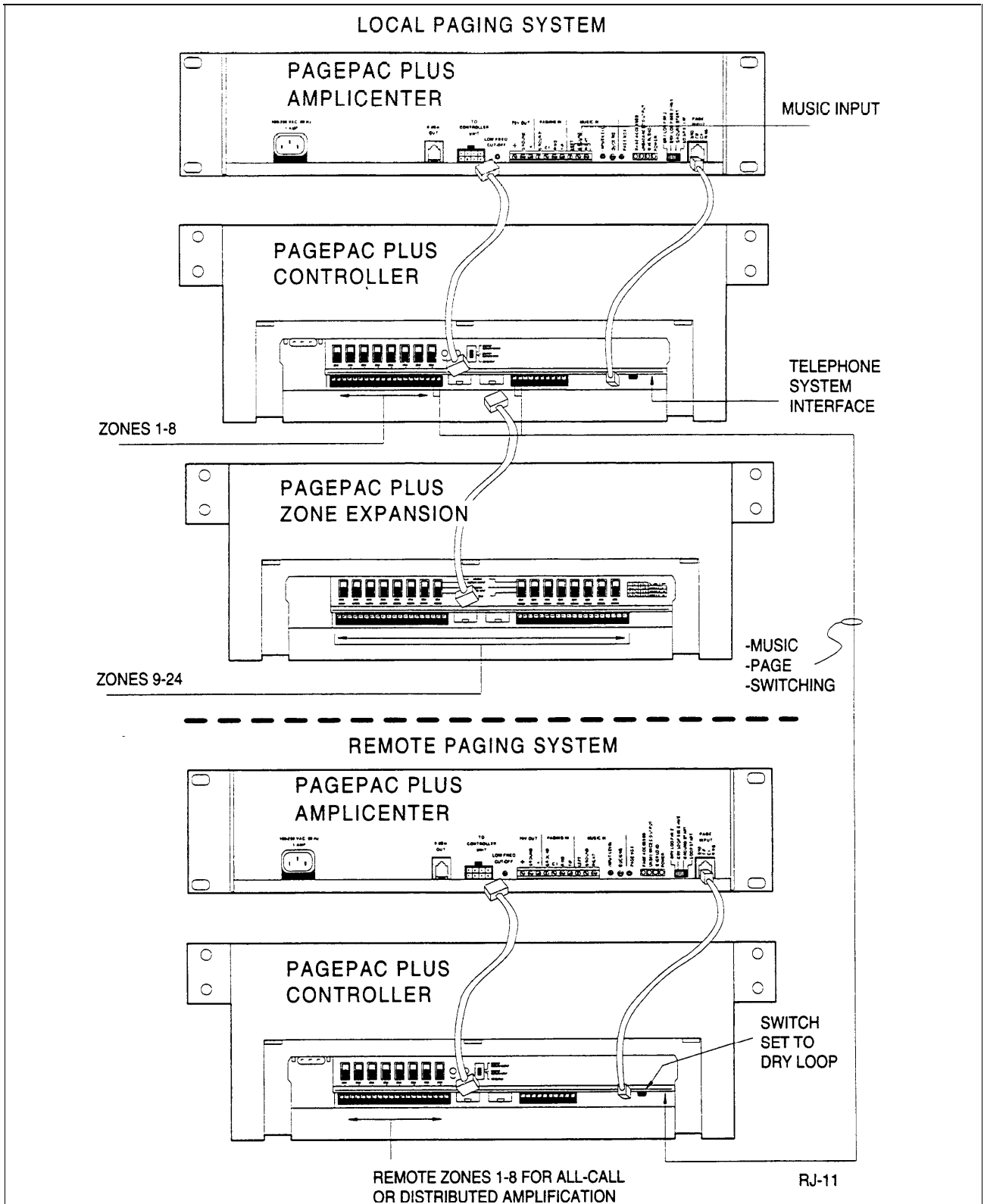

Figure A-7. System with Additional Controller / Remote Amplifier

Index

A		Controller	
About this guide	i-vii	Back panel nomenclature	1-11
Activate tone via an input closure	2-40	Front panel	1-11
Additional controller		Rear panel	1-11
Diagram	A-14	Controller unit	1-12
Alarm system input	A-7	Copy command	2-17
Alarm system interface			
Diagram	A-8	D	
ALIAS zone numbers	1-16	Default inputs	1-8
ALIAS number	2-7	Door control	A-5
Amplicenter	1-3, 1-12, 1-14	Door control interfaces	
Amplicenter interface	1-9	Diagram	A-6
Answering the doorbell	A-5	Door service	2-34, 2-35
Application notes	1-7, A-1	Door speaker	3-3
Attendant access	1-8	Door unlock	A-5
Audio routing	2-34, 2-40	Doorbell	2-34
Audio source	2-34	Doorbell tone	3-3
Audio source enabled	2-40	DTMF	2-3, 2-29
B		E	
Back panel		EKTS	A-1
Diagram	1-13	Enter programming mode	3-2
Background music	A-3	Error tones	2-36
		Expansion zones	1-9
C			
Centrex system	A-1	F	
Comment on this guide	viii	Factory defaults	
Computer monitor	2-15, 2-37	Reset to	2-6
Input	2-16	FCC	
Computer monitor logging interface		Interference notice	ii
Diagram	A-12	Features and capabilities	1-7
Computer monitor paging log	A-1 1	Feedback form	B-1, viii
Configuration tables	1-22		
Confirmation tone	2-37	G	
Confirmation tone on/off	2-11	General zone group configurations	2-16
Connect password	2-37, 3-2	Getting started	viii
Connectors	1-11, 1-14		

H

Hardware	
Configuration	1-10
Installation	1-6
How to use this guide	vii

I

Indicators	1-11
Input #1	1-8
Input #2	1-8
Input computer monitor	2-16, 2-37
Input priority	2-20
Installation	vii
Interface considerations	1-15
Interfaces	1-15

L

LED indicators	1-11
----------------	------

M

Make a voice page	3-2
Managing the system	1-6
Monitor	
Computer	2-15, 2-21
Mode	2-15, 2-21
Music	
Background	A-3
Music enable	2-26, 2-39,
Music input	1-9
Music interfaces	
Diagram	A-4

N

Night bell	1-3, 2-28, A-1
Night bell circuit	1-8
Night bell enable	2-39
Night bell interfaces	
Diagram	A-2
Notice	
Number of zone map digits	2-37

O

Operation	vii, 1-7, 3-1 - 3-5
Ordering information	1-11
Output types	1-10
Output zone	2-23
Overview and features	vii

P

Page enable	2-25, 2-39
PagePac Plus	
Constant voltage distribution system	1-11
Controller system	1-11
Features	1-3
Hybrid system	1-11
System components diagram	1-5
Paging system quick reference card	3-5
Paging zones	1-9
Addresses	1-15
Pass DTMF to the output	2-29, 2-39
Password	2-8
Forgot?	2-11
Programming	2-10
Selecting	2-9
PBX	8-1
Power	1-14
Power up	2-4, 3-2
Pre-announcement tone	2-12, 2-37
Product ordering	viii
Programming	1-3, vii, 2-1 - 2-40
ALIAS numbers	2-18
Audio routing	2-35
Audio Source	2-34
By PC	2-3
Default values	2-4
DTMF to output	2-30
Enter	2-37
Entering mode	2-5
Input or output zones	2-19
Input zones	
Introduction	2-3
Music enable	2-26
Night bell	2-28
Options and instructions	2-5
Output zones	2-24
Page enable	2-25
Password	2-10, 2-37

Quick reference chart	2-37	Tones	
Talkback	2-27	Description of	2-32
Tone muting	2-33	Error	2-36
Touchtone telephone	2-3	Trademarks	ii
Zone grouping	2-22	Training	1-6
Programming memory	1-10	Type of output	2-39
Programming password	3-2	Type of zone	2-38

Q

Quick reference chart	2-3, 2-37
-----------------------	-----------

R

Reference materials	viii
Remote amplifier	
Diagram	A-14
Remote amplifiers	A-1 3
Reset to factory defaults	2-37
RS-232	1-14, 2-3

S

Security door control	1-3
Security Protection	1-4
Software configuration	2-4
Solving problems	1-6
Support telephone numbers	ii
System administrator	3-2
System configuration options	2-5
System handshake	2-23
System settings	1-6

T

Talkback	1-3, 1-10, 2-27, A-9
Talkback enable	2-39
Talkback warning tones	2-13, 2-37
Telephone access	1-3, 1-8
Telephone mode	1-15
Telephone numbers	
support	ii
Tone generator	1-10
Tone routing	2-33, 2-40
Tone selection	2-31

U

Unlock the door	3-3
User quick reference card	3-4
Using telephone to make a voice page	3-2

V

VOX timer disconnect	2-37
----------------------	------

W

Warranty	ii
Wrong password entered	3-2

Z

Zone	
ALIAS zone number	1-16
Assigning ALIAS numbers	2-18
Group	2-4
Group configurations	2-23
Grouping	2-22
Individual zones	2-4
Input	2-31
Input or output	2-19
output	2-23
Physical zone code	1-16
Physical zone number	1-16
Zone configuration tables	
input zones	1-23
Zone expansion unit	1-3, 1-12
Zone grouping	2-38
Zone map	1-16, 1-18, 2-38
Zone map example	1-17
Zone map option	2-18
Zone monitor	2-21
Zone option switches	1-15, 2-3
Caution	2-5
Zone switches	1-14

©1993 AT&T
All rights reserved
Printed in U.S.A

AT&T 463-248-204
011722580-002
Issue 3, May 1993

Graphics © AT&T 1988