

DESIGNATION STRIPS AND CARDS

1. GENERAL

1.01 This section contains information on designation strips and cards.

1.02 This section is reissued to:

- Revise Tables A and B
- Show E-5253 Designation Tab as no longer available.

Since this reissue covers a general revision, arrows ordinarily used to indicate changes have been omitted.

1.03 Designation strips and cards are used to indicate on which key or pushbutton a particular PBX extension, central office line, or other service appears on multibutton telephone sets or keys.

2. IDENTIFICATION

2.01 Table A list designation strips and telephone sets on which they are used. Table B lists keys which are not equipped with designation card holders.

2.02 Refer to appropriate section on keys, key mountings, consoles, lamp sockets, subscriber sets, etc. for information covering "E" forms and designation strips for these items.

MESSAGE WAITING	DESK	LOCAL	LONG DISTANCE
--------------------	------	-------	------------------

812758837(P-27E883)

E-4227-G

Fig. 1—Designation Cards

NOTICE

Not for use or disclosure outside the
Bell System except under written agreement

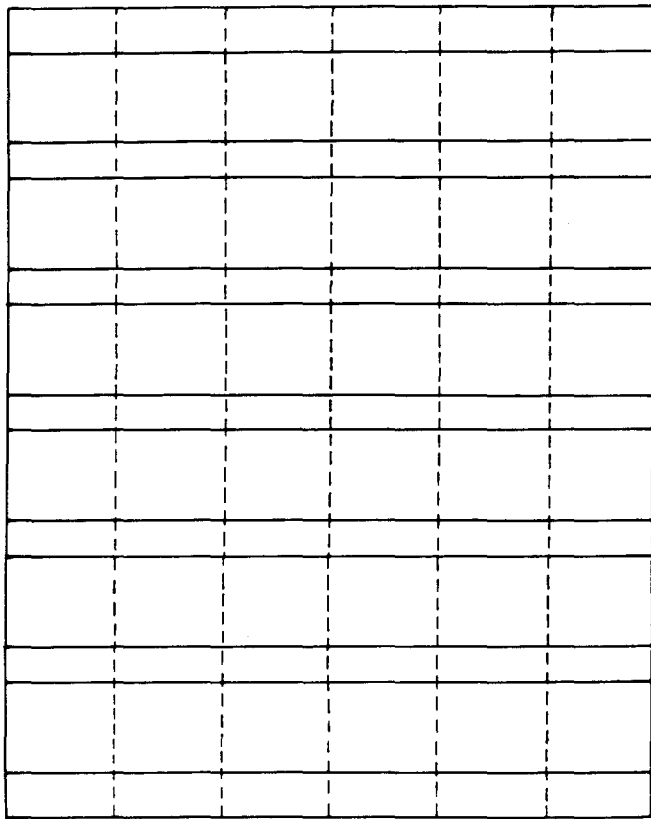

Fig. 2—E-4646 Designation Strip

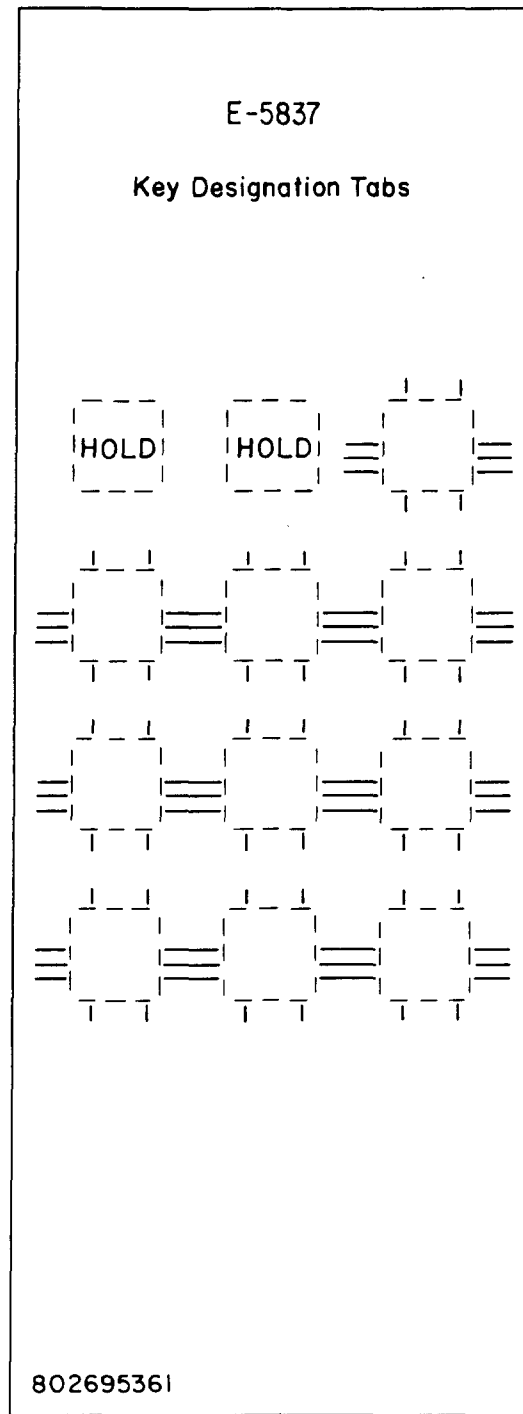

Fig. 3—802695361 (E-5837) Designation Tabs

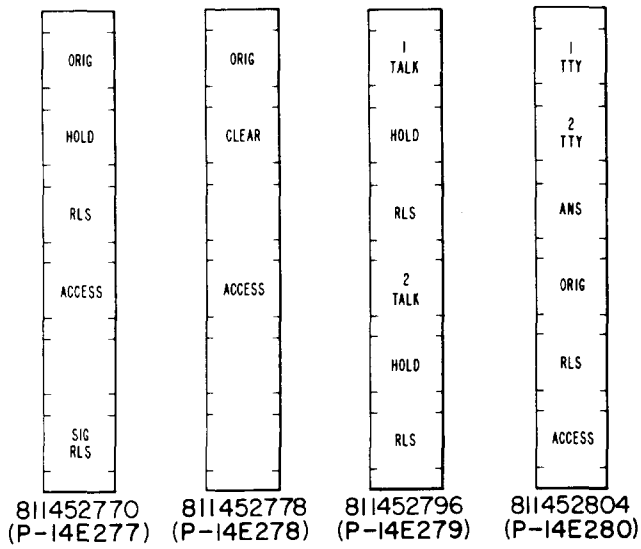

Fig. 4—Designation Strips

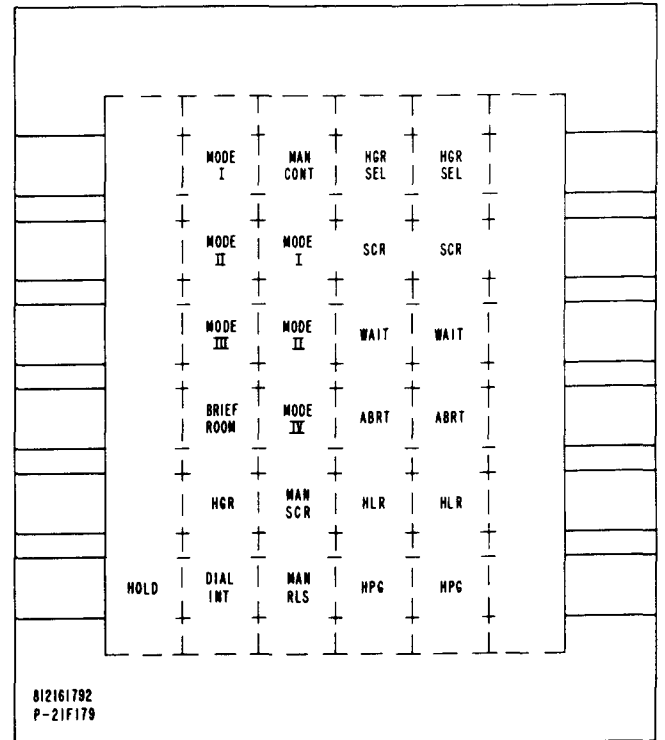

Fig. 6—812161792 (P-21F179) Designation Strip

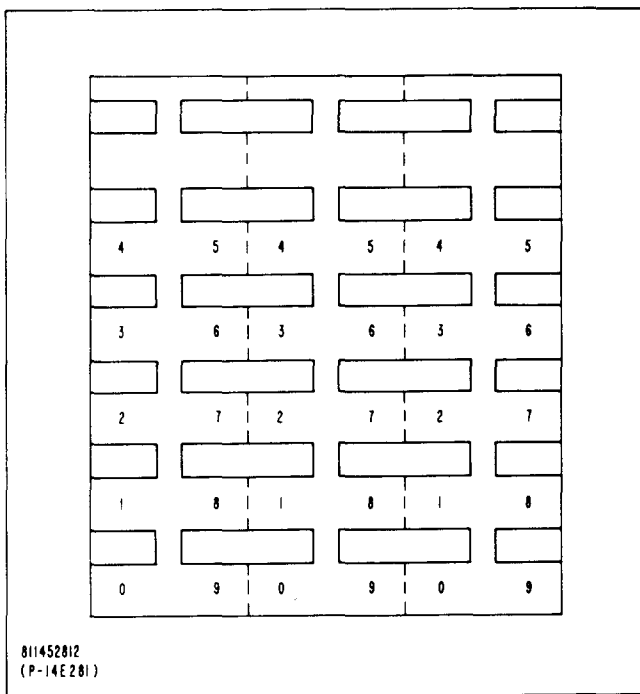

Fig. 5—811452812 (P-14E281) Designation Strip

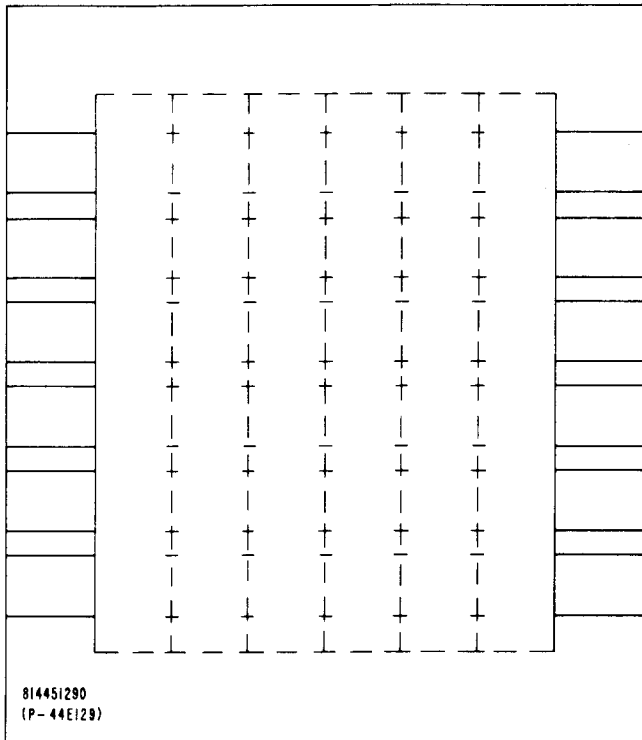

Fig. 7—814451290 (P-44E129) Designation Strip

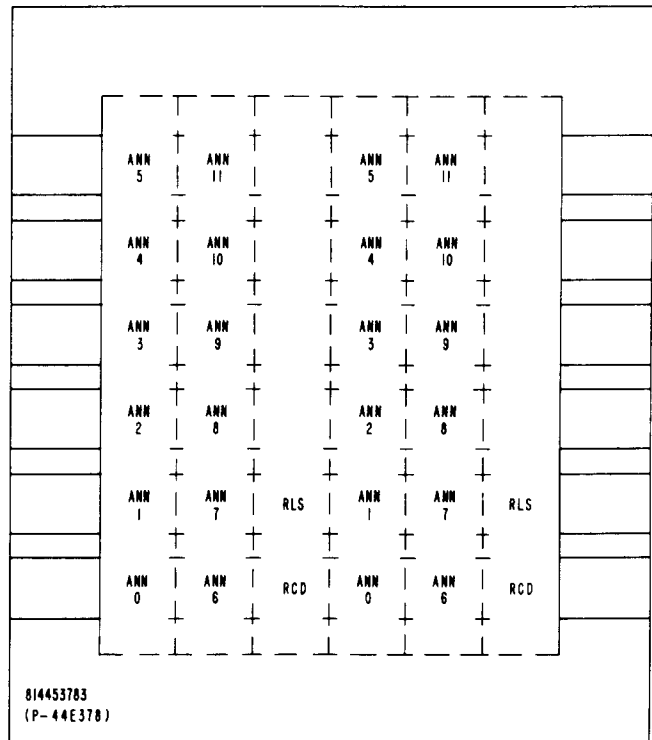

Fig. 9—814453783 (P-44E378) Designation Strip

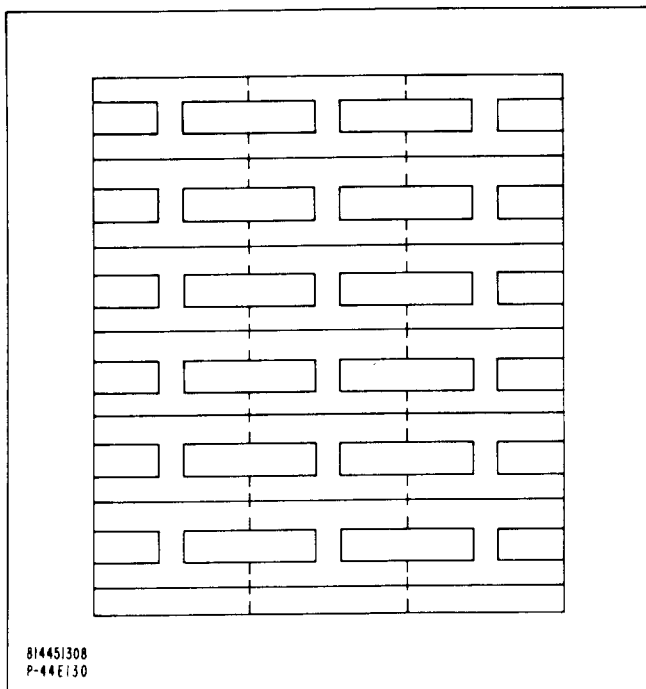

Fig. 8—814451308 (P-44E130) Designation Strip

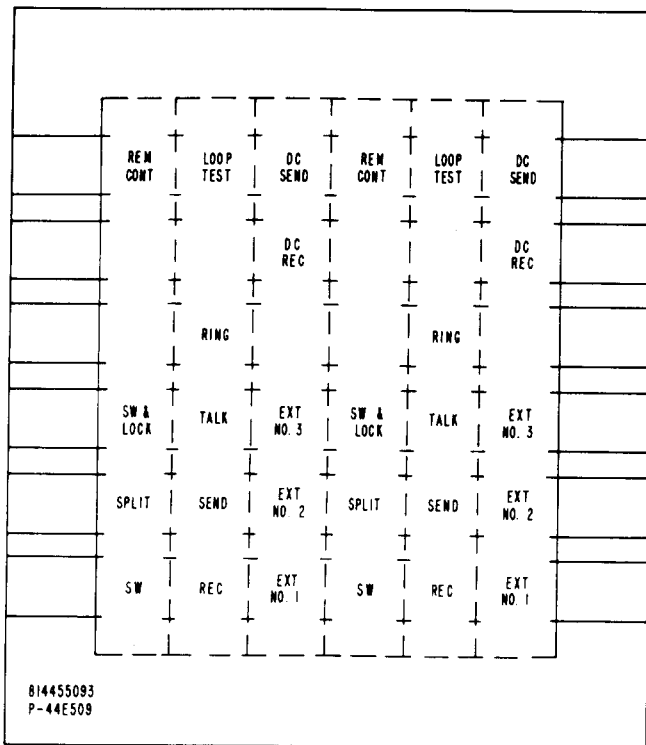

Fig. 10—814455093 (P-44E509) Designation Strip

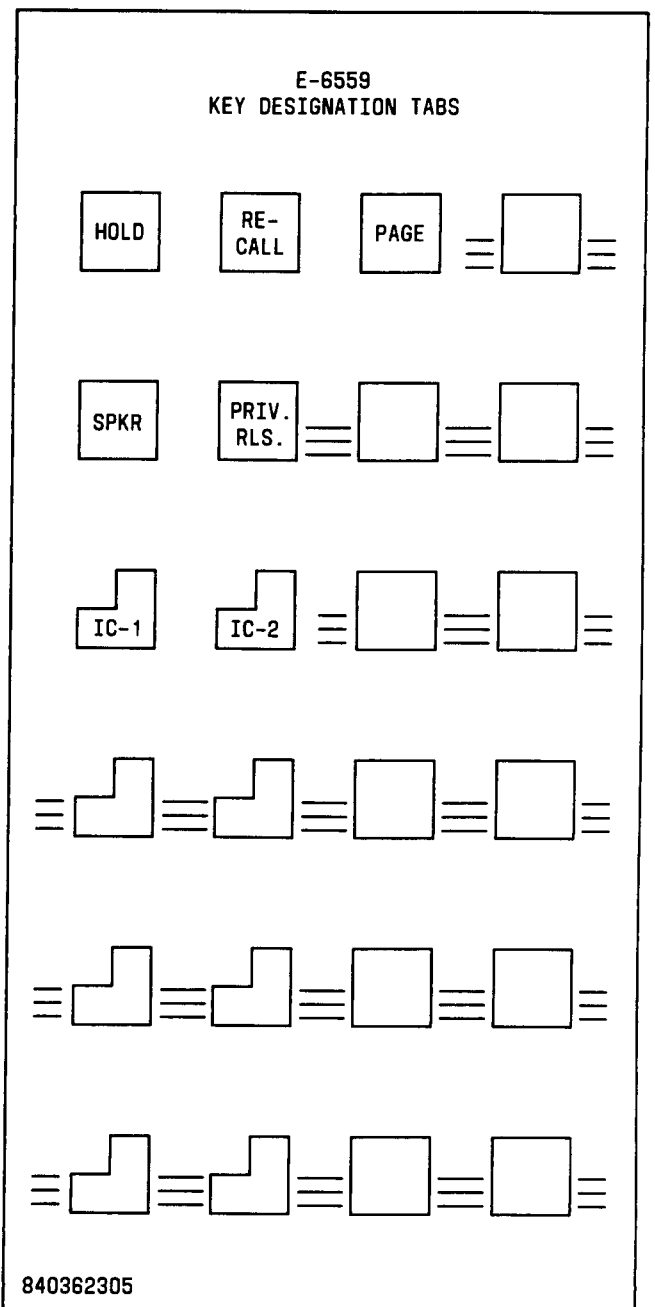

Fig. 11—840362305 (E-6559) Designation Tabs

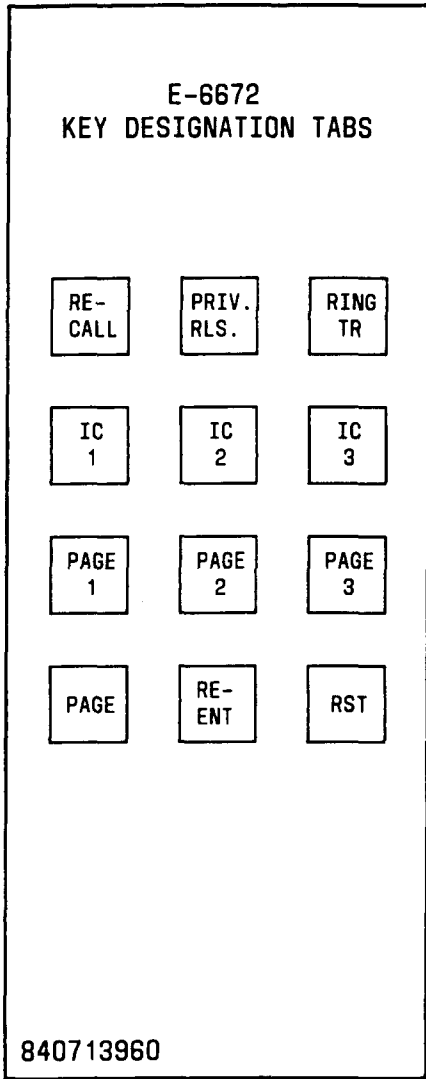

Fig. 12—840713960 (E-6672) Designation Tabs

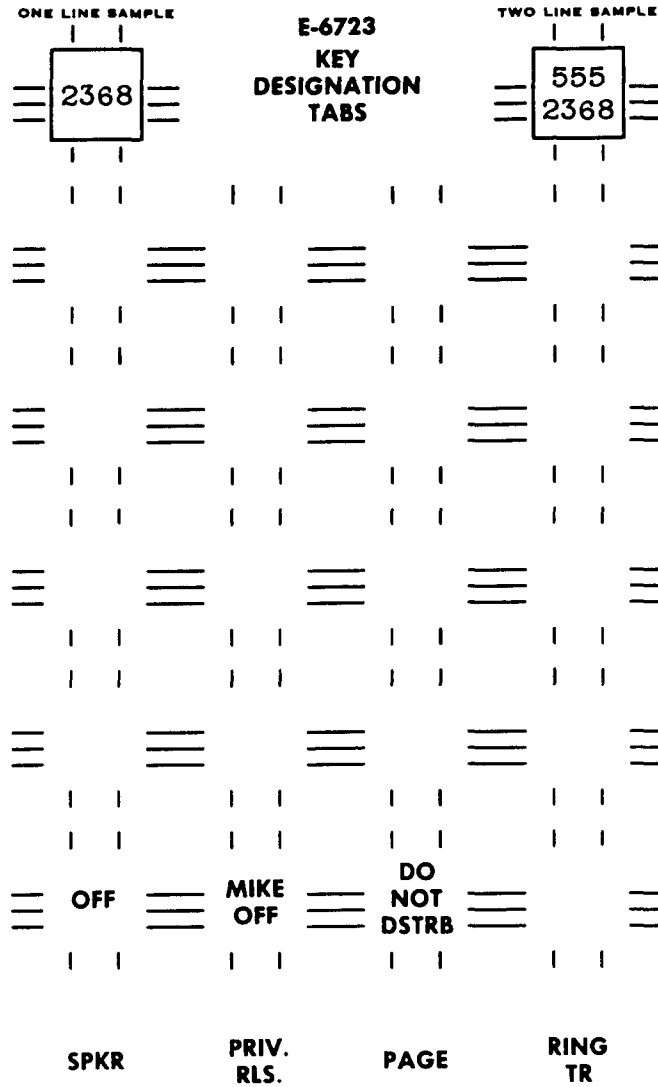
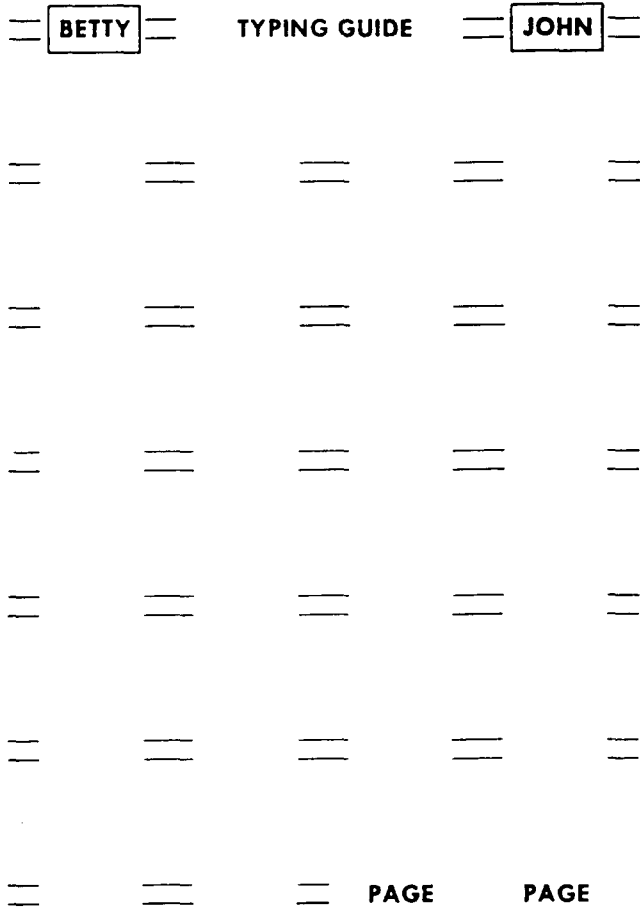

Fig. 13—841009111 (E-6723) Designation Tabs

E-6873
KEY DESIGNATION TABS



841026909

Fig. 14—841026909 (E-6873) Designation Tabs

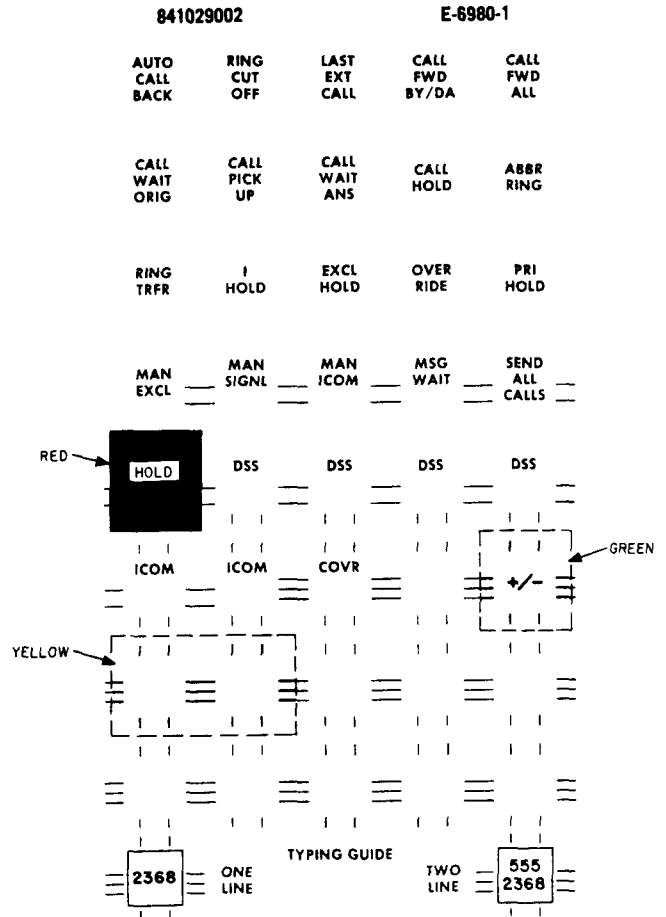

Fig. 15—841029002 (E-6980-1) Designation Tabs

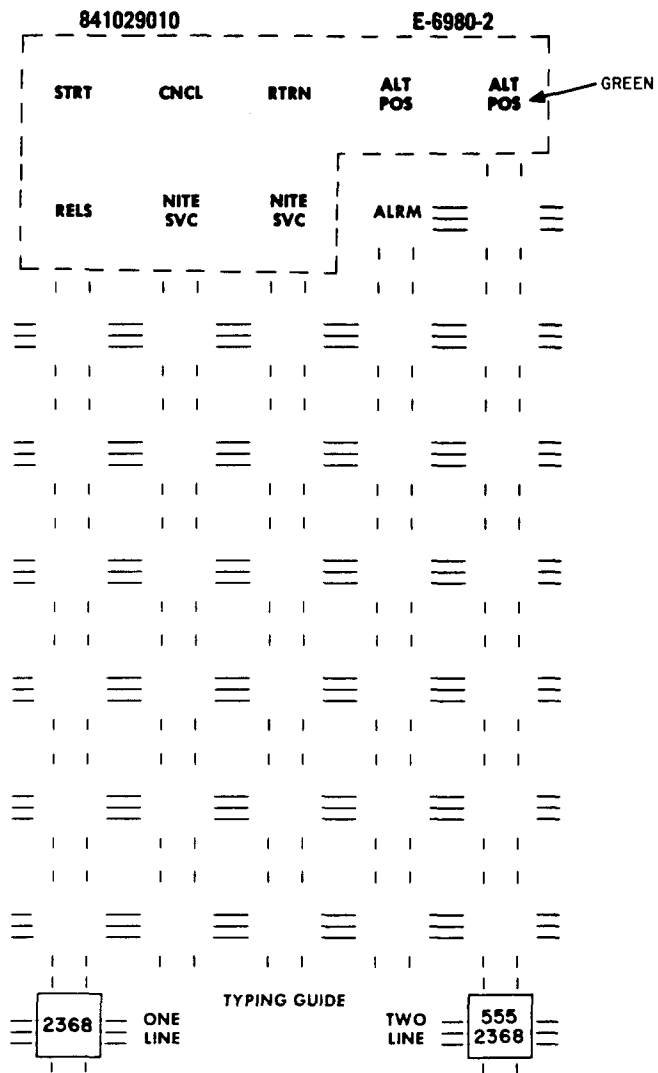

Fig. 16—841029010 (E-6980-2) Designation Tabs

◆ TABLE A ◆

INTENDED USE OF DESIGNATION STRIPS AND CARDS

DESIGNATION STRIP COMCODE NUMBER OR CARD FORM NUMBER	FIG. NO.	TELEPHONE SET
E-4227-G	1	563-, 564-, 565-, 566-, and 568-type, 575AM, 2563-, 2564-, 2565-, and 2568-type, and 2575AM.
E-4646	2	630- and 2630- series
802695361 (E-5837)	3	630-series; 830CM, DM; 831CM, DM; 832BM, CM, DM, EM; 833BM, CM, DM, EM; 851CM; 852AM; 872A1M; 2630- series; 2752A, B; 2754A, B; 2830CM, DM; 2831CM, DM; 2832BM, CM, DM, EM; 2833BM, CM, DM, EM; 2851CM; 2852AM; 2872A2M; 3568-, 3640A-, 3641A-, 3666A1A-, and 3666A1B- type; 3673A1, and 3673A7.
811452770 (P-14E277)	4	609B
811452788 (P-14E278)		
811452796 (P-14E279)		
811452804 (P-14E280)		
811452812 (P-14E281)	5	
812161792 (P-21F179)	6	643A3
812758837 (P-27E883)	1	543-type
814451290 (P-44E129)	7	617B-, 618B-, and 619A-type; 623A3; 680-, and 681-type; 682AA, AAM; 683AA, AAM; 2623A3; 2626A1; 2660A1M; 2662A-, and 2664A-type; 2682AA, AAM; 2683AA, AAM; 2684A- and 2685A-type; and 3623A3
814451308 (P-44E130)	8	2685A-type
814453783 (P-44E378)	9	624A10-type
814455093 (P-44E509)	10	625A1
840362305 (E-6559)	11	836AM, 837AM, 2836AM, and 2837AM
840713960 (E-6672)	12	830DM, FM; 831DM; 832BM, CM, DM, EM; 833BM, CM, DM, EM; 2830DM, FM; 2831DM; 2832BM, CM, DM, EM; and 2833BM, CM, DM, EM
841009111 (E-6723)	13	981-, 983-, 2981-, and 2983-type
841026909 (E-6873)	14	
841029002 (E-6980-1)	15	2991-, 2992-, 2993-, and 2994-type
841029010 (E-6980-2)	16	

◆ TABLE B ◆

DESIGNATION STRIPS FOR KEYS NOT EQUIPPED
WITH DESIGNATION CARD HOLDERS

DESIG STRIP CODE	KEYS	WINDOW PIECE PART	APPROX. SIZE OF DESIG CARD*
			INCHES
98A	6017 6030	804670346 (P-467034)	9/16† by 5/16
8AD	6019	804670454 (P-467045)	5-5/16 by 3/4
8AE	6012	804670463 (P-467046)	3-15/16 by 3/4
8AF	6009		
8AG	6002 6011	804670472 (P-467047)	2 by 5/8

* The designation card should be the same size as the acetate window. Any good grade of paper may be used. Supplied locally.

† Use designation card 804768828 (P-476882).