

STATION DIALS

5, 6, 7, AND 8-TYPES

IDENTIFICATION AND MAINTENANCE

1. GENERAL

1.01 This section is reissued to:

- Delete information on Manufacture Discontinued (MD) 5-type dials.
- Show 6D-61 dial.
- Change color of lead on 8-type dials.
- Show new fingerwheel for 8E dial.
- Revise text and illustrations.

Since this reissue covers a general revision, arrows ordinarily used to indicate changes have been omitted.

2. IDENTIFICATION

5M-3 DIAL

2.01 Intended for use with 5300-type telephone sets. See Fig. 1 and Table A for assembly of parts, and Fig. 2 for schematic.

2.02 The 164A number plate (Fig. 3) is intended for general station use with 5- and 6-type dials. (See Table B for other number plates available for use with 5- and 6-type dials.)

6-TYPE DIALS

2.03 See Tables D and E and Fig. 4 for usage and assembly of parts.

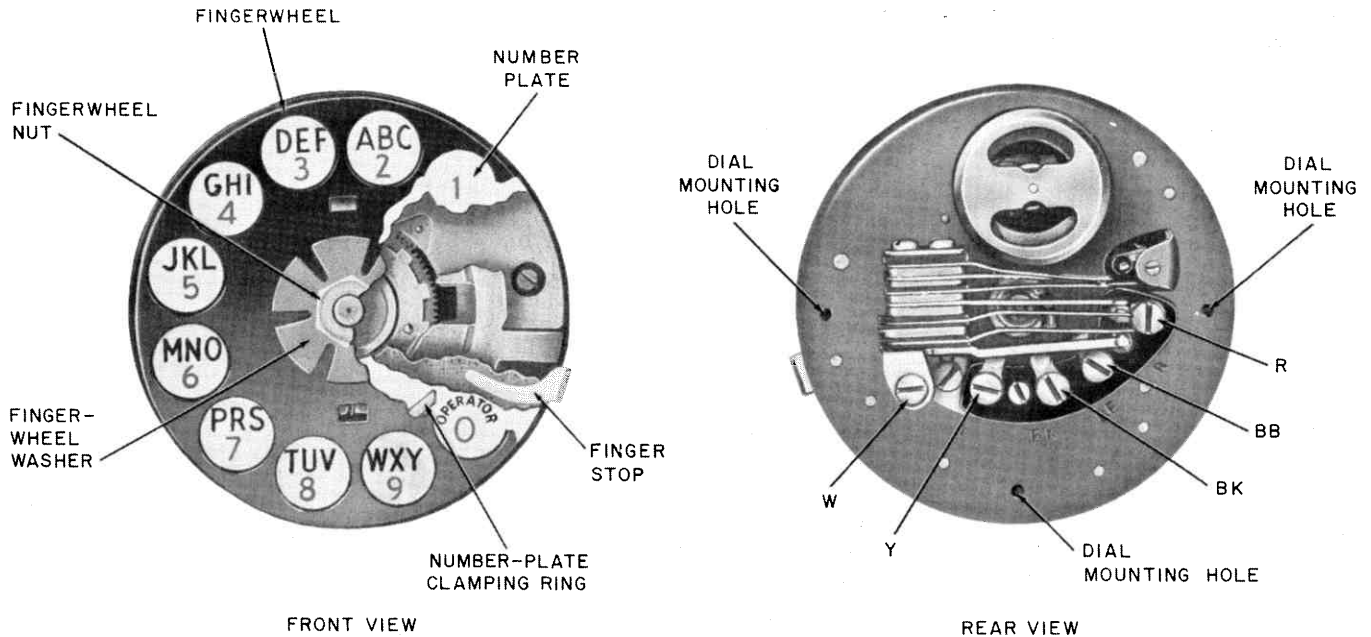

Fig. 1 — 5M-3 Dial

TABLE A
ASSEMBLY OF PARTS FOR 5M-3 DIAL

DIAL TYPE	NUMBER PLATE	CARD HOLDER ASSEMBLY	FINGERWHEEL	FINGERWHEEL WASHER	FINGERWHEEL NUT	DIAL MOUNTING SCREW
5M-3	164C-3	Not Required	*P-19B524 (plastic)	P-459447	P-153996	P-131556
		P-298106	P-153971 (metal)			

* See Table C.

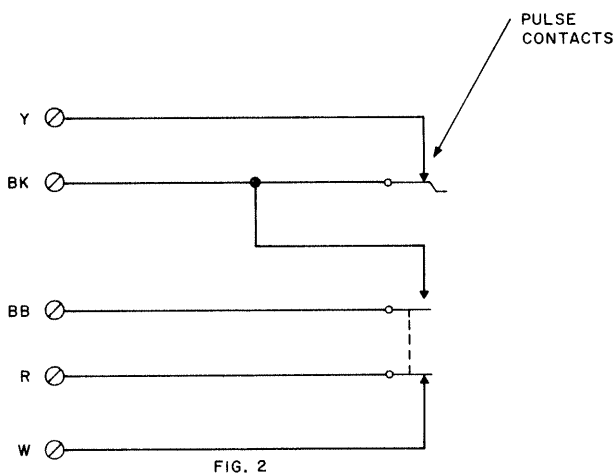

Fig. 2 — 5M-3 Dial Contact Schematic

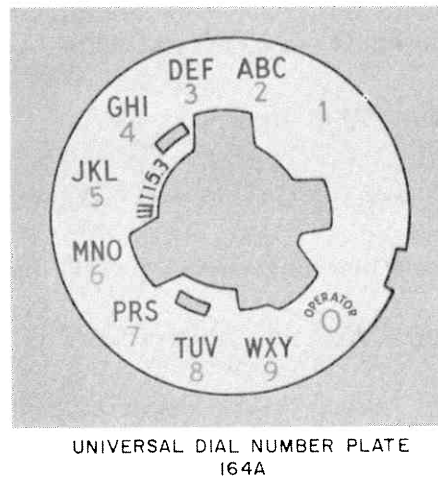

Fig. 3 — 164A Number Plate

TABLE B
NUMBER PLATES FOR 5- AND 6-TYPE DIALS

CODE	NUMERALS	LETTERS	USE
147B	Red	Black	With 56A dial adapter and 5-type dial on coin collectors. Also used on 320- and 325-type telephone sets
158B-3 158B-51 158B-60			With 63A dial adapter and 6-type dial on coin collectors
164A			5- and 6-type dials
164B	Numerals and letters omitted		5- and 6-type dials in 5300-type telephone sets
164C-3			6L, M, and N dials
164D			

TABLE C
PLASTIC FINGERWHEEL ASSEMBLY FOR 5-, 6-, AND 7-TYPE DIALS

DIAL TYPE	FINGERWHEEL ASSEMBLY	FINGERWHEEL CLAMP	CLAMP PLATE	FINGERWHEEL	PLASTIC WINDOW	CARD SUPPORT
5	*P-43A212	P-347999	—	P-19B524	P-137593	P-479182
6	*P-43A342	—	P-11E206			
7						

* MD. The component parts are available but must be ordered separately.

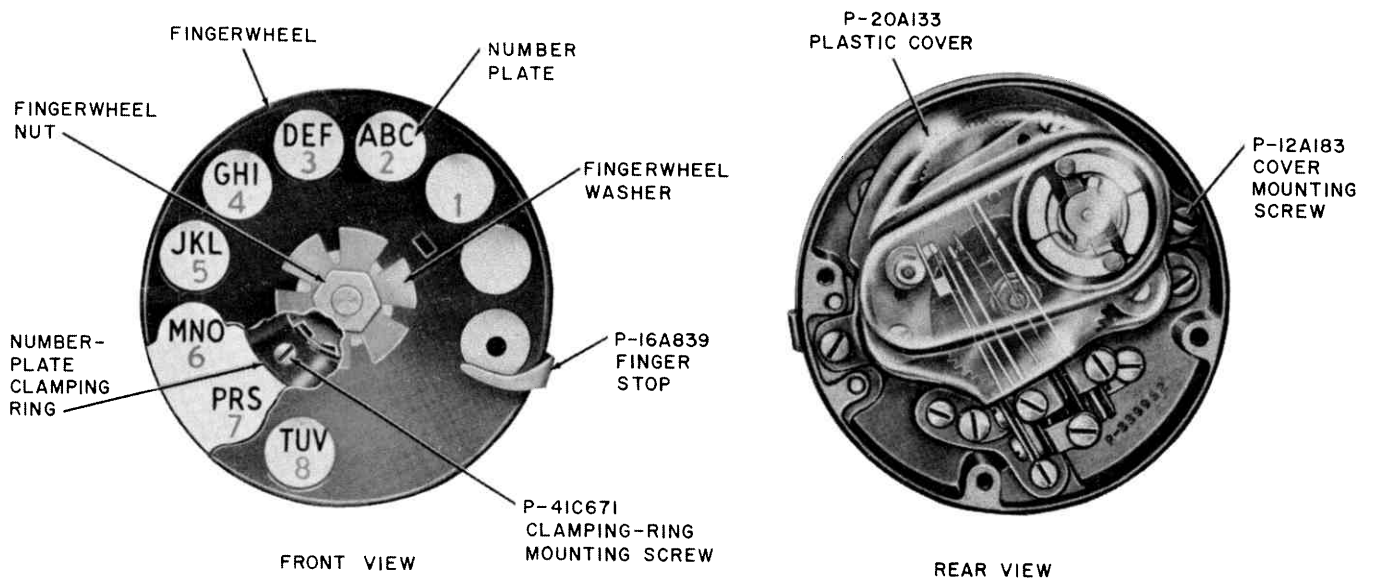

Fig. 4 — 6-Type Dial

TABLE D
USE OF 6-TYPE DIALS

DIAL TYPE	SCHEMATIC FIG.	PULSES PER SECOND	USE
6A-3	5B	10	Subscriber stations. Also part of 1011G handset.
6C-3			Coin collectors with a 158B number plate and a 63A dial adapter.
6D-3			211MR-3 and 212MR-3 hand telephone sets.
6D-41			751A apparatus unit (MD)
6D-61			212LRW-61 hand telephone set

TABLE D (Cont)
USE OF 6-TYPE DIALS

DIAL TYPE	SCHEMATIC FIG.	PULSES PER SECOND	USE
6E	5A	10	PBX and central office switchboards
6E-41			520 PBX, emergency reporting system
6F	5A	20	PBX and central office switchboards arranged for high-speed dialing.
6F-43			608A PBX
6G	5B	20	555-type PBX
6H-3			5300-type telephone sets
6J-3	5C	10	211P-3 and 211PR-3 hand telephone sets
6J-41			750A apparatus unit
6K-41			112A key equipment in SAGE systems
6L-41			600-type telephone sets
6M-3	5B	10	223- and 233-type coin collectors
6N-3			610-type telephone sets for 756 PBX
6P-43	5A	10	608A PBX
6P-45			JCSAN/COPAN networks at U.S. Air Force installations
6R-3	5B	10	PBX and order turrets
6S-3	5C	10	525B telephone set

TABLE E
ASSEMBLY OF PARTS FOR 6-TYPE DIALS

DIAL TYPE	NUMBER PLATE	CLAMP PLATE	FINGERWHEEL	CARD HOLDER ASSEMBLY	CARD RETAINER GROUP	CARD SUPPORT
6A-3	164A		P-349543	P-298106		
6C-3	164B					
6D-3	164A	P-11E206	P-19B524*		P-43A457	
6D-41			P-11C079			
6D-61		P-11E206	P-19B524*	P-298106		
6E			P-349543			
6E-41		P-11E206	P-19B524*			

TABLE E (Cont)
ASSEMBLY OF PARTS FOR 6-TYPE DIALS

DIAL TYPE	NUMBER PLATE	CLAMP PLATE	FINGERWHEEL	CARD HOLDER ASSEMBLY	CARD RETAINER GROUP	CARD SUPPORT
6F	164A	P-11E206	P-349543	P-298106		
6F-43			P-19B524*			
6G						
6H-3	164C-3		P-349543	P-298106		
6J-3						
6J-41	164A					
6K-41	164B	P-11E206	P-11C079		P-43A457	
6L-41	164D		P-11E007			
6M-3			P-19B524*			
6N-3		P-11E007				
6P-43	164A		P-19B524*			
6P-45						
6R-3						
6S-3	164B		P-349543	P-298106		

* See Table C.

Note: P-12A937 clamping ring, P-459447 fingerwheel washer and P-153996 fingerwheel nut is part of above dials.

7-TYPE DIALS

2.04 See Tables F and G and Fig. 6 for usage and assembly of parts.

8-TYPE DIALS

2.05 See Tables H and I and Fig. 8 for use and assembly of parts and Table J for number plates.

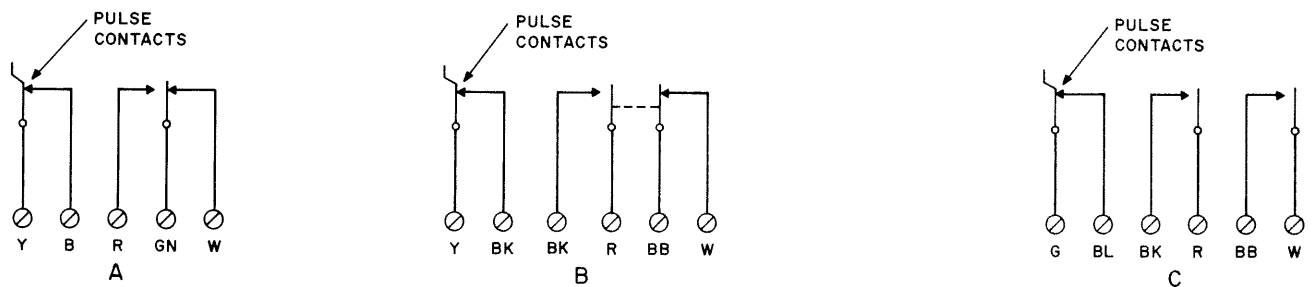

Fig. 5 — 6-Type Dial Contact Schematics (See Table D)

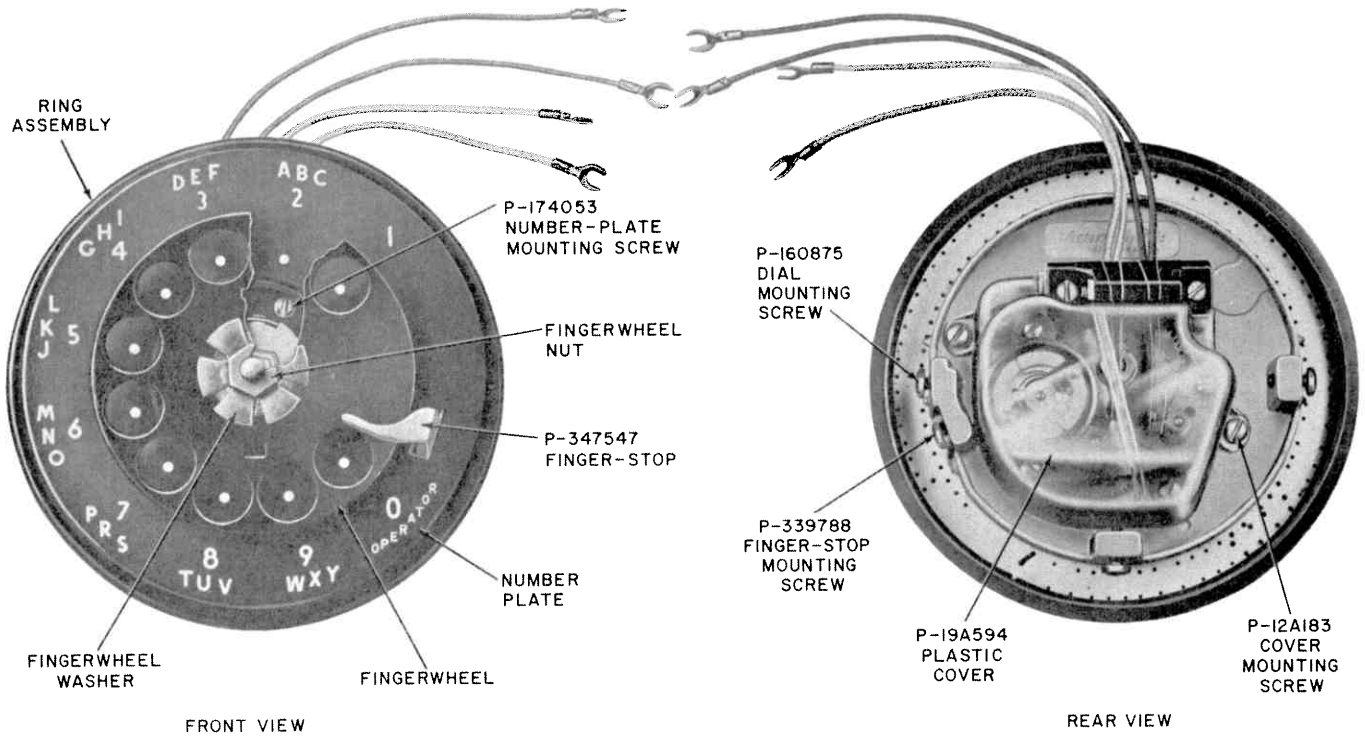

Fig. 6 — 7-Type Dial

TABLE F
USE OF 7-TYPE DIALS

DIAL TYPE	SCHEMATIC FIG.	PULSES PER SECOND	USE
7A-3 (MD)	7A	10	General station
7C-* (MD)			General station with color
7D-3 (MD)			Replaces 7A
7E-3 (MD)	7C		Speakerphone, 1A and 1A1 key systems
7F-3	7B		Air Defense Warning System (CADW)
7G-3 (MD)	7C		532-, 533-, 535-, and 536-type telephone sets
7H-* (MD)			Same as 7G-3; use on color sets
7J-* (MD)			Same as 7H
7K-3 (MD)			Modular telephone panels
7L-3 (MD)			691A-3 subscriber set, Data Set 101A

* Available in standard colors.

TABLE G
ASSEMBLY OF PARTS FOR 7-TYPE DIALS

DIAL TYPE	NUMBER PLATE	CLAMP PLATE	FINGERWHEEL	FINGERWHEEL WASHER	FINGERWHEEL NUT	RING ASSEMBLY	
7A-3 (MD)	P-349755	P-11E206	P-19B524†	P-459447	P-153996	P-347300	
7C-* (MD)	P-80A4-*					P-17A422	
7D-3 (MD)	P-80A403	P-349543	P-347300				
7E-3 (MD)							
7F-3						P-344917	
7G-3 (MD)	P-80A403	P-349543					
7H-* (MD)	P-80A4-*	P-11E206				P-19B524†	P-17A422
7J-* (MD)							
7K-3 (MD)	P-81H503						
7L-3 (MD)	P-83A203		P-349543			P-347300	

* Available in standard colors.

† See Table C.

3. MAINTENANCE

GENERAL

3.01 Only items listed in the identification section shall be replaced in the field.

3.02 Dial should operate smoothly without slipping or skipping pulses. It should not require excessive windup force nor stop on slow return.

- Check by operating dial several times.
- Replace dial if it fails to meet requirements in 3.02 or if wrong numbers are suspected.

3.03 Cardholder tabs on underside of the fingerwheel should clear the number plate clamping ring.

- Remove cardholder from fingerwheel to readjust tabs.

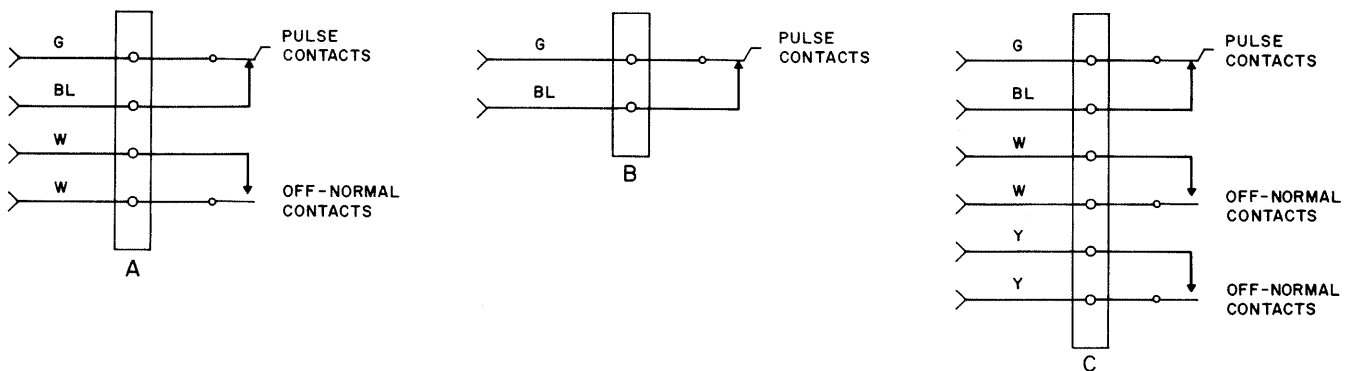

Fig. 7 — 7-Type Dial Contact Schematics (See Table F)

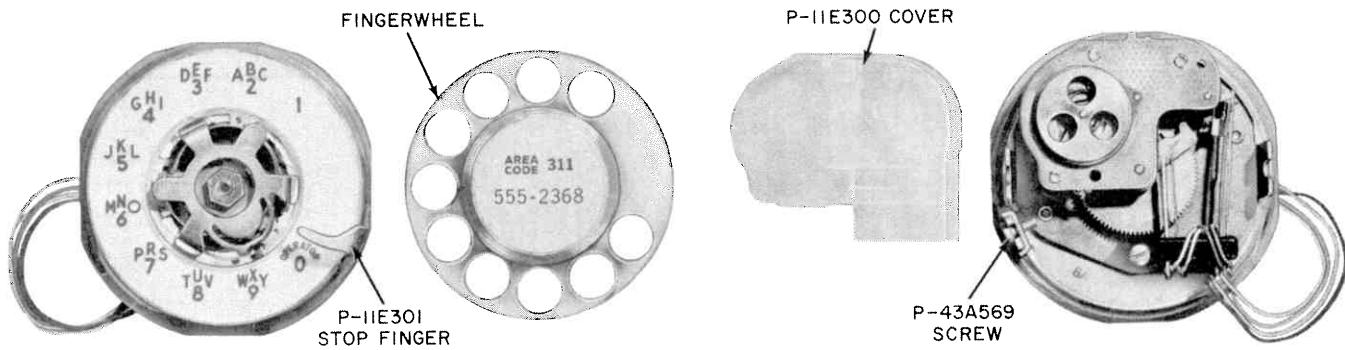

Fig. 8 — 8-Type Dial

TABLE H
USE OF 8-TYPE DIALS

DIAL TYPE	SCHEMATIC FIG.	PULSES PER SECOND	USE	
8A	9A	10	701-type telephone sets	
8B	9B		102A key equipment at FAA installations, 112A key equipment at NORAD installations	
8C-58			600-type telephone sets	
8E-52	9A		1A1 coin telephone sets	
8E-61			11A and 11B apparatus units for 200, 400, and 600 series data sets	
8F			32A, 33A, or 35A teletypewriter	
8G	9C		670A1, 670A4 and 670A7 telephone sets	
8H (MD)			11-type apparatus units for data set 202C and data auxiliary set 804A2	
8J	9B		20	Telephone consoles in 1A and 2A telephone answering service systems
8K-58				3C and 4B telephone consoles
8L-58	9A	10	235G-67A coin collector	
8M-52	9D		14A1- and 15A1-type telephone consoles	
8P-58	9B			

TABLE I
ASSEMBLY OF PARTS FOR 8-TYPE DIALS

DIAL TYPE	NUMBER PLATE	CLAMP PLATE	FINGERWHEEL	INDEX RING	FINGERWHEEL NUT
8A	P-11E295	P-11E291	P-11E007	P-12E059	P-44E959
8B					
8C-58	P-81K158				
8E-52	P-83B352		P-21F299	P-83B252	
8E-61	P-83B361			P-83B261	
8F	P-15E831			P-12E059	
8G	P-24E565				
8H (MD)	P-83B958				
8J	P-15E831		P-11E007	P-12E059	
8K-58	P-81K158				
8L-58					
8M-52	P-83B352			P-83B252	
8P-58	P-81K158				

TABLE J
NUMBER PLATES FOR 8-TYPE DIALS

NUMBER PLATE	BACKGROUND COLOR	COLOR OF NUMBERS OR DOTS	COLOR OF LETTERS
P-11E295	White	Brown	Brown
P-81K158		Black	Black
P-15E831		Gray	Gray
P-83B958		Black	
P-83B352	Oxford Gray	White	
P-83B361	Light Gray	Oxford Gray	
P-24E565	Gray	White	

3.04 The number plate should not be marred or the enamel chipped. The characters should be clearly legible.

- Clean dirty number plate with damp KS-2423 cloth.

- Replace broken number plates rather than replace the dial.

3.05 Parts of the dial shall not be broken or missing. (A broken buffer spring on a 5-type dial is permissible, Fig. 10.)

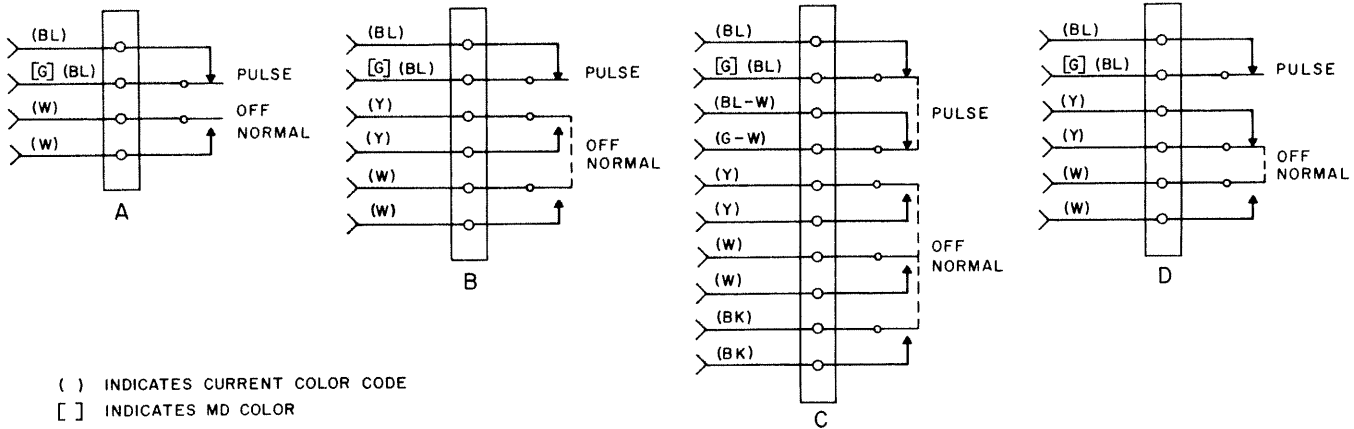

Fig. 9 - 8-Type Dial Contact Schematics (See Table H)

- Replace dial if dial case hole threads are stripped.

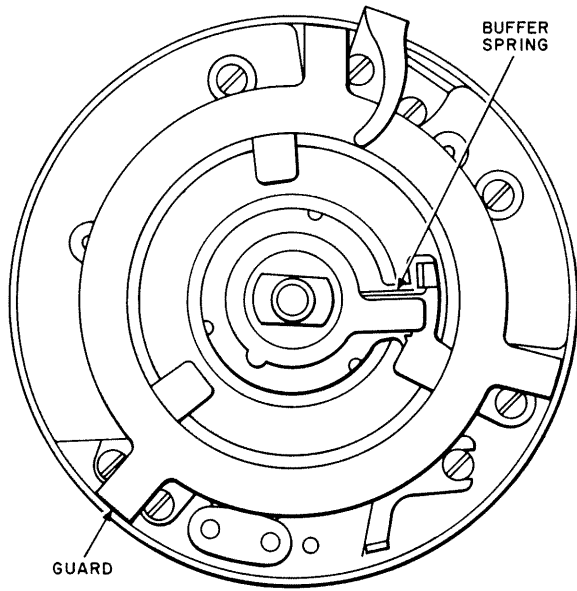

Fig. 10 - 5-Type Dial Showing Buffer Spring and Metal Guard

- 3.06 The finger stop should not be loose or distorted. With the dial in its unoperated position the finger stop shall not cover any portion of the "0" hole of the fingerwheel on the 5-type dial and not more than 3/64-inch on the 6-, 7-, and 8-type dials.

- 3.07 Cord tip terminations of the dial should be tightly clamped by their associated screws and not touching any other metal parts or adjacent cord tips.

DIAL STRAPS

- 3.08 When 5- or 6-type dials are used in station circuits where the R spring is not normally required, it is necessary to strap dial terminals R and BB with P-290076 dial straps as shown in Fig. 11.

DIAL CONTACT REQUIREMENTS

- Missing screws, washers, and eyelets should be replaced.
- All mounting screws should be in place and tight.
- Unused terminal screws should be securely tightened.
- Replace screws having stripped threads.

- 3.09 Contacts which test open should be cleaned by burnishing with a 265C tool.

- 3.10 Off-normal contacts should not move until the fingerwheel has moved at least 1/16 inch.

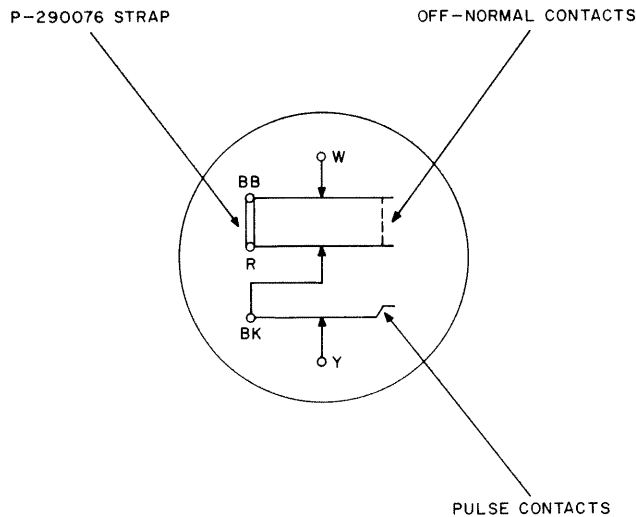

Fig. 11 — Use of Dial Straps

3.11 On rundown of the dial the shunt contacts should not open until the last pulse is completed.

3.12 If above requirements are not met, replace the dial.

DIAL SPEED TEST

3.13 In central offices equipped with automatic dial test equipment, test dial speed in the following manner:

- (1) Obtain dial tone.
- (2) Dial code number for dial speed test.
- (3) After dial tone is heard again, dial one of the following digits:
 - Digit number 2 (test for 8 to 11 pulses per second)
 - Digit number 3 (readjust, test for 9.5 to 10.5 pulses per second).
- (4) Listen for dial tone again, dial digit 0. One of the following audible signals will indicate how the dial meets the requirements of the test:
 - Ringing induction — dial speed satisfactory

- Rapidly interrupted dial tone — dial speed fast
- Slowly interrupted dial tone — dial speed slow.

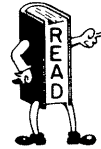

The 20-pulse-per-second dial, or so-called high-speed dial, should not be used on customer station equipment. See 2.03 and 2.05.

3.14 If dial test circuits are not available, be guided by local instructions for testing dial speed.

DIAL SPEED ADJUSTMENTS (5-TYPE DIAL)

3.15 The speed of the 5-type dial shall be within a minimum of 8 and maximum of 11 pulses per second. If the requirement is not met, adjust to a minimum of $9\frac{1}{2}$ or to a maximum of $10\frac{1}{2}$ pulses per second.

(a) Use a 260 tool to adjust the speed as follows:

- (1) Place 260 tool on dial governor (Fig. 12) to hold the movable parts.
- (2) Loosen governor adjusting screw enough to permit movement of the adjusting arm.
- (3) Move adjusting arm toward F (to increase speed) or toward S (to reduce speed), gauging the amount of movement by the adjusting marks (Fig. 12).
- (4) Tighten adjusting screw and remove tool.
- (5) With receiver on-hook, dial 0 and visually determine if desired change in speed has been realized.
 - If Central Office is equipped with automatic dial test equipment, see 3.13.
- (6) Replace dial if speed cannot be adjusted to meet requirements.

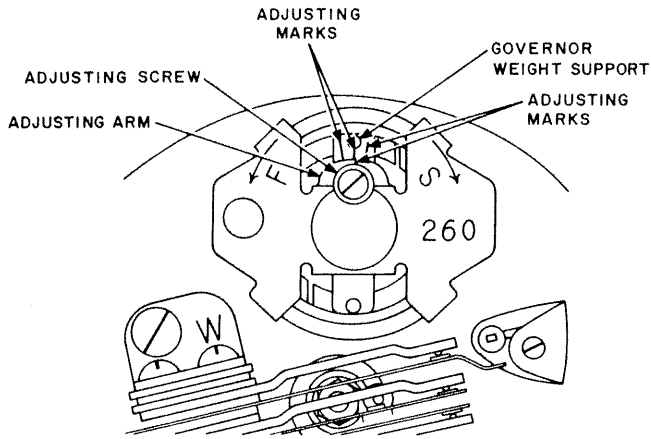

Fig. 12 — Dial Governor with 260 Tool in Place

3.16 The speed of 6-, 7-, and 8-type dials is not adjustable and the dial should be replaced when speed requirements are not met.

FINGERWHEEL

3.17 The fingerwheel shall not wobble in excess of 1/16-inch at its outside edge throughout its full travel. Inspect visually.

3.18 Clearance between edge of fingerwheel and finger stop at all points when 0 is dialed shall be 1/64-inch minimum. Inspect visually.

3.19 Dials on which fingerwheels have been replaced and which still do not meet the above clearance requirements shall be replaced. These dials probably have bent shafts.

3.20 If the fingerwheel is removed for any reason, fingerwheel washer P-459447 (if not already present) shall be placed between the fingerwheel and the fingerwheel nut, (Fig. 13) except when a plastic fingerwheel is used on 5-type dial.

3.21 If the fingerwheel is removed from a 6- or 7-type dial of early manufacture, install a P-12A951 hub retainer (Fig. 13) to prevent the motor spring and hub assembly from jumping out of its proper position. (Replace dial if this occurs.) Dials of later manufacture (identified by a black finish fingerwheel nut)

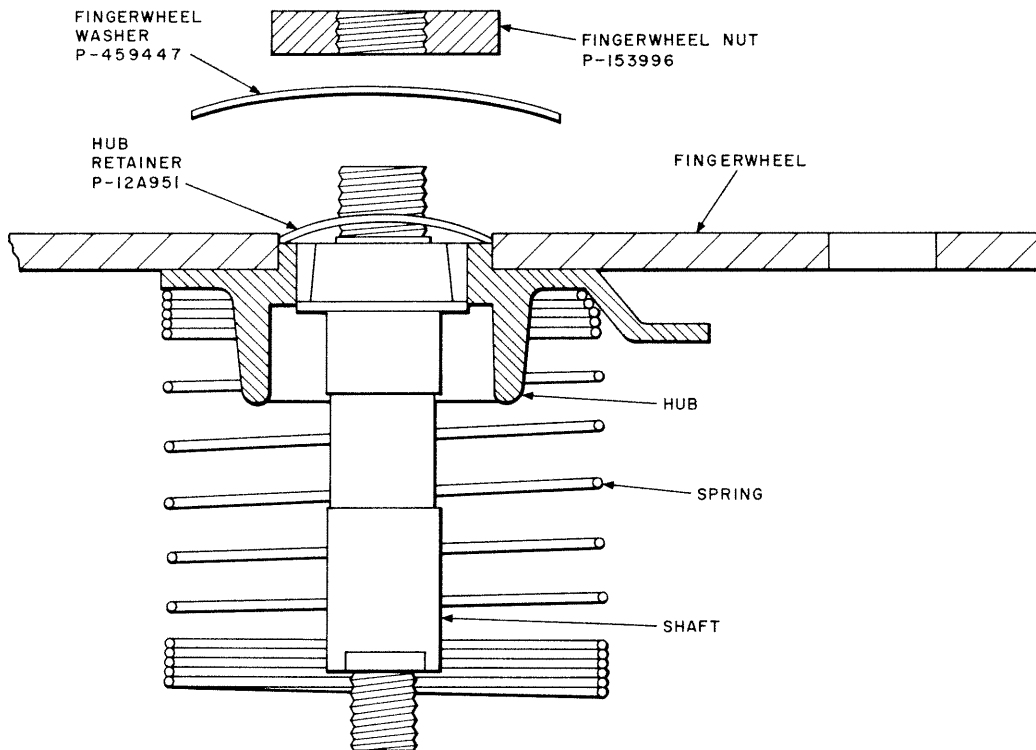

Fig. 13 — Dial Hub Retainer and Spring Washer

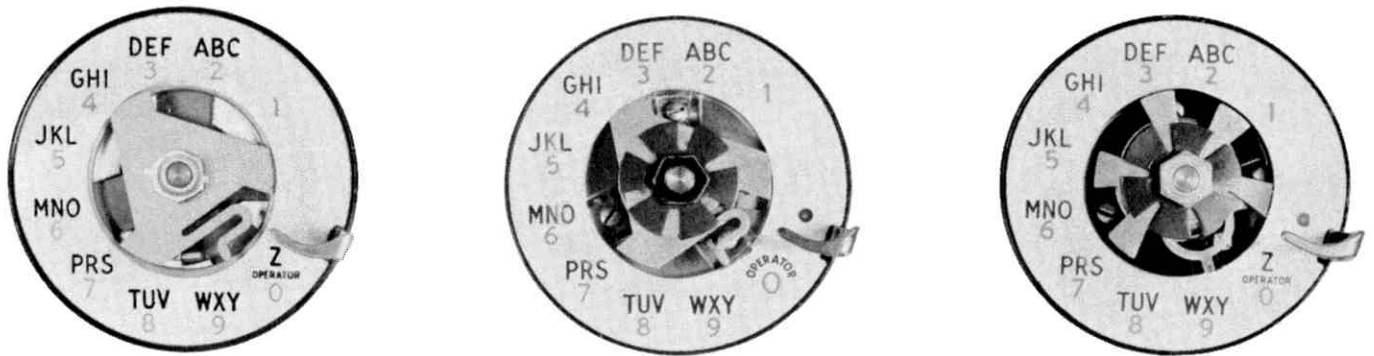

Fig. 14 — Clamp Plates Mounted on Dials

have either been equipped with a retainer or the hub has been staked on the shaft.

PLASTIC FINGERWHEEL

3.22 Install as follows:

- (1) With dial in normal position, place fingerwheel clamp on dial hub so that spring portion is near digit 9 on number plate, as shown in Fig. 14.
- (2) Place fingerwheel washer and nut on hub and tighten (omit spring washer on 5-type dial).
- (3) Place station number card in fingerwheel between window and card support.

(4) Place fingerwheel over clamp with 0 hole directly on digit 9, making sure fingerwheel depressions are properly positioned on prongs of clamp plate, as shown in Fig. 15 (A).

(5) Rotate fingerwheel in counterclockwise direction until clamp spring snaps into notch on underside of fingerwheel, as shown in Fig. 15 (B).

3.23 Remove as follows:

- (1) Rotate fingerwheel in clockwise direction as far as possible.
- (2) Insert KS-16750, List 2 releaser into small hole located in edge of raised center of fingerwheel, as shown in Fig. 16 and push down to disengage the fingerwheel clamp spring. Continue to rotate the fingerwheel in a clockwise direction.
- (3) When clamp spring releases, remove fingerwheel and dial will return to normal.

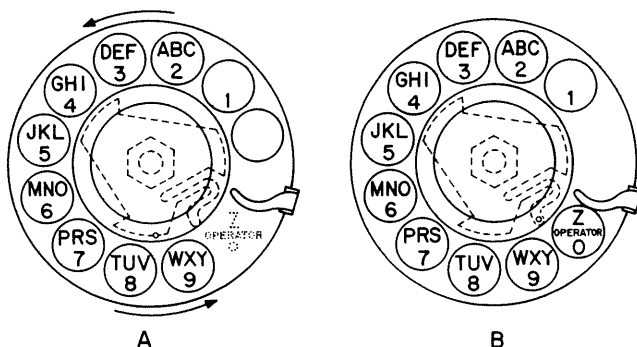

REPLACING PLASTIC FINGERWHEEL

Fig. 15 — Placing Plastic Fingerwheels

NUMBER PLATES

3.24 5-Type Dial

- (a) To change the number plate, remove the card holder, fingerwheel nut, washer, fingerwheel, and number-plate clamping ring.
- (b) When replacing clamping ring over number plate, first insert a prong of clamping ring into lower slot in number plate, and then

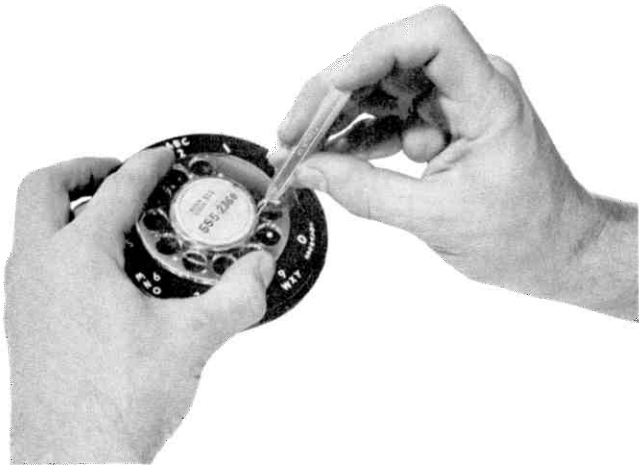

Fig. 16 — Removing Plastic Fingerwheel

force the other two prongs into remaining slots.

(c) The 164C3 number plate used with 5M or 6H dial helps to simulate 7-type dial when used on 5300 and 5400 series telephone set, as shown in Fig. 17.

3.25 6-Type Dial

(a) To remove number plate on a dial with a metal fingerwheel, remove the card holder, fingerwheel nut, fingerwheel (see 3.23 for plastic fingerwheel), and two exposed screws.

(b) To replace number plate, reverse above procedures.

3.26 7-Type Dial

(a) To remove the number plate on dial with metal fingerwheel, remove the cardholder, frame, fingerwheel nut, washer, fingerwheel, finger stop, and two P-174053 BHM shoulder-type special screws.

(b) To remove number plate on a dial with a plastic fingerwheel, follow the sequence in Fig. 16, 18, 19, and 20.

(c) To replace number plate, reverse above procedures.

Note: Reuse ring assembly from old number plate.

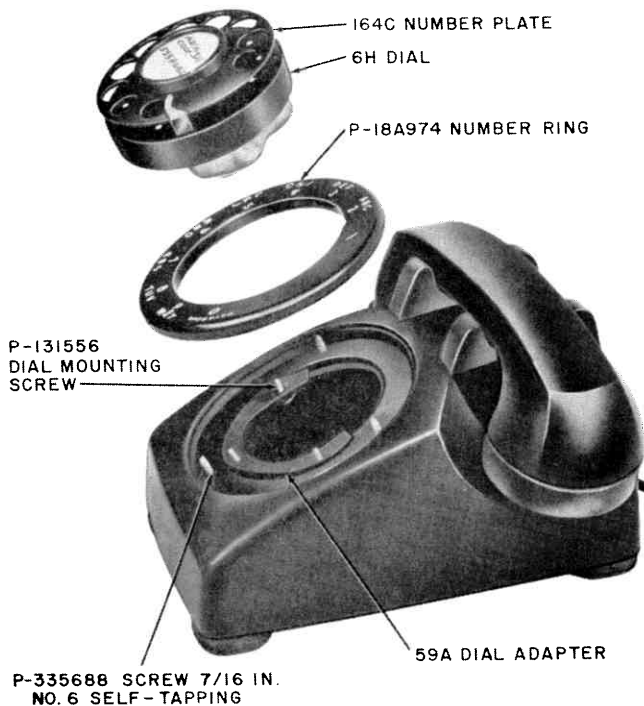

Fig. 17 — 6H Dial and P-18A974 Number Ring

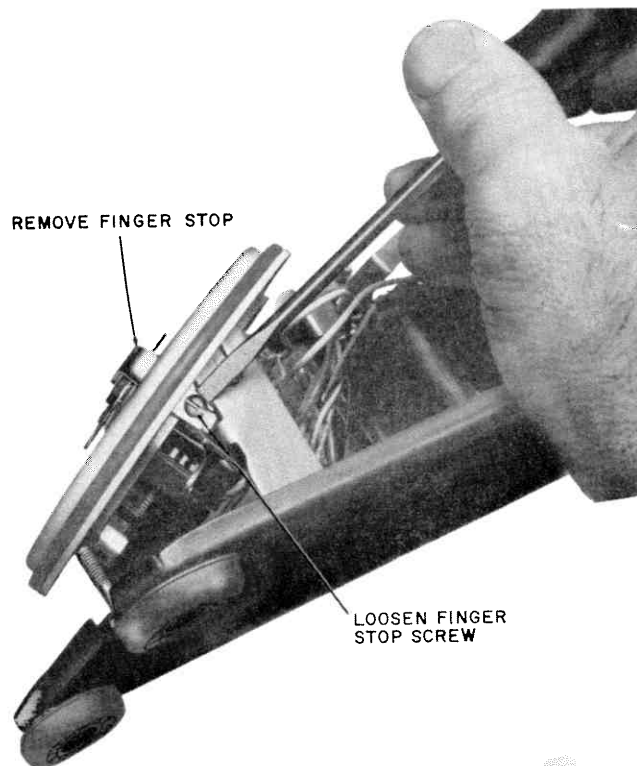

Fig. 18 — Removing Finger Stop

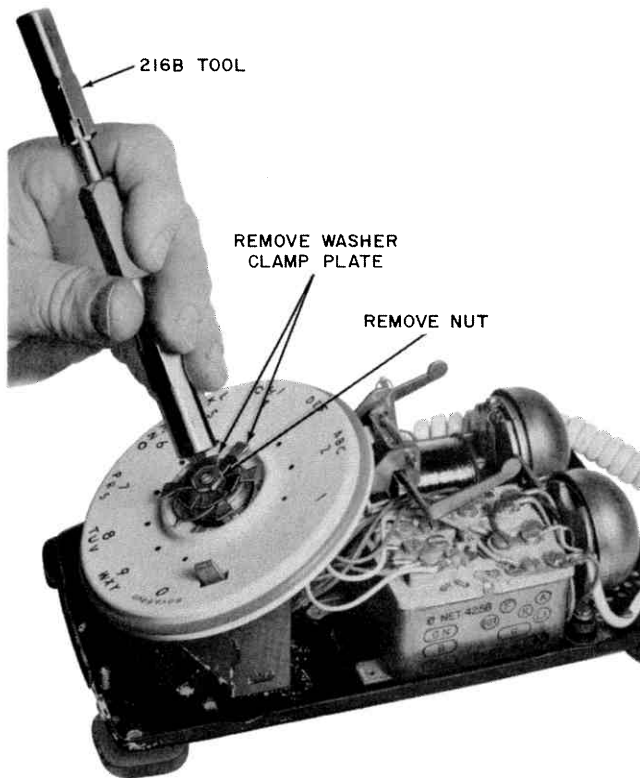

Fig. 19 — Removing Nut, Washer, and Clamp Plate

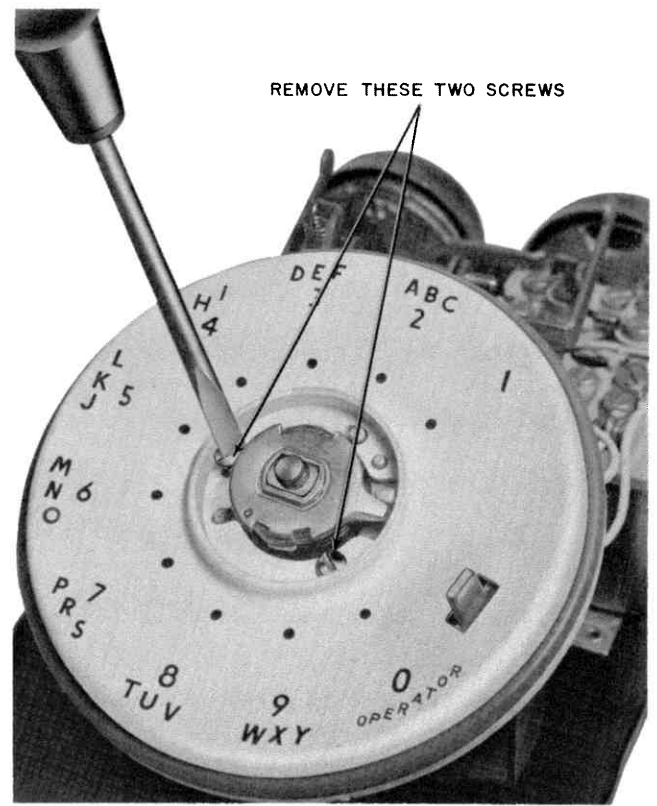

Fig. 20 — Removing Number Plate Screws

3.27 8-Type Dial

(a) To remove number plate:

- (1) Remove plastic fingerwheel (see 3.23).
- (2) Remove lock ring by rotating ring counterclockwise until it is free (Fig. 21). Then raise ring until it is just under clamp plate and slide toward rear of dial (Fig. 22) until upper end of ring can be lifted over clamp plate. Slide ring toward front of dial and remove.
- (3) Lift number plate off dial.
- (4) Before placing new number plate on the dial, wipe face of light shield clean.

(b) To replace number plate, reverse above procedures.

(c) When changing from one color to another, the index ring must also be changed. See Table I for piece part information.

ADJUSTMENTS TO PREVENT MECHANICAL NOISE — 6- AND 7-TYPE DIALS

3.28 In 6- and 7-type dials, the motor gear meshes with the intermediate gear on the governor gear train assembly (Fig. 23).

3.29 Excessive noise, binding, or lockup may be caused by:

- Too much backlash (loose mesh)
- Too little backlash (tight mesh).

3.30 For proper operation of dials, a slight perceptible backlash is required.

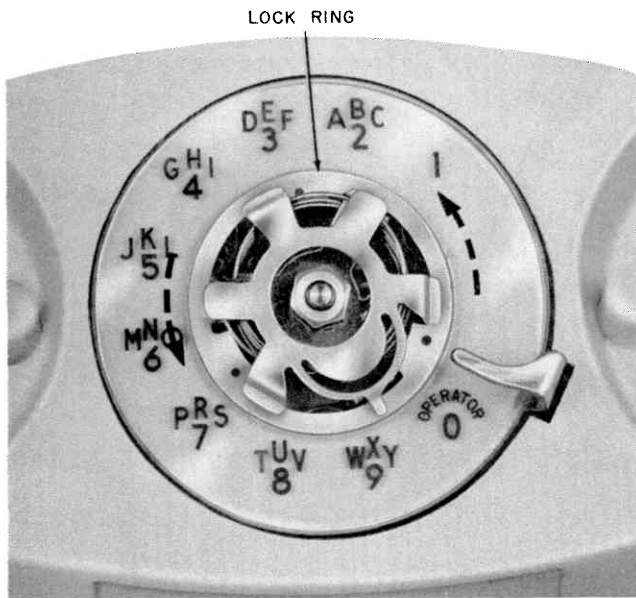

Fig. 21 — 8-Type Dial, Fingerwheel Removed to Show Lock Ring

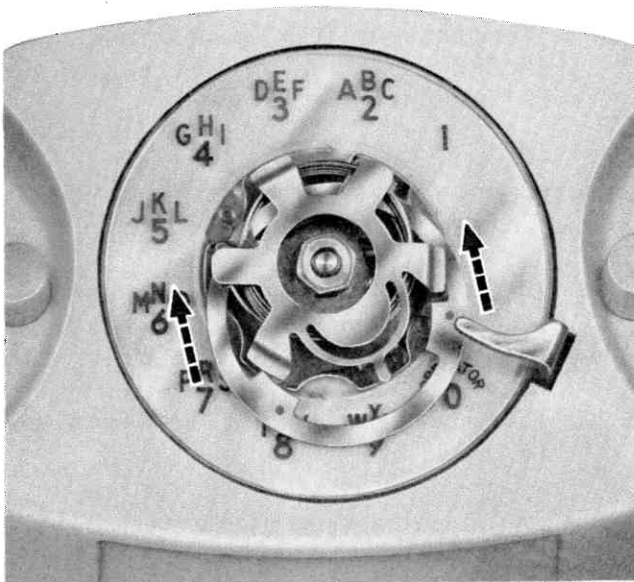

Fig. 22 — Lock Ring in Extreme Forward Position for Removal

3.31 To get the “feel” of the gears, dial a series of zeros. Keep the finger in fingerwheel hole so that improper mesh can be felt either on wind-up or run-down.

3.32 For a more positive backlash test, proceed as follows:

- (1) Remove housing from set.
- (2) Remove dial from dial mounting (Fig. 24). It is not necessary to disconnect spade tip conductors.
- (3) Remove the dust cover from dial (Fig. 25).

After dust cover is removed, do not touch dial contacts or governor. These two assemblies are carefully adjusted at the factory. Any distortion will change the percent break in pulsing contacts or speed of governor.

- (4) Grasp rim of fingerwheel with thumb and fingers. Rotate fingerwheel about 1 inch and hold in this position.
- (5) Hold intermediate gear immobile with index finger of other hand (Fig. 26).

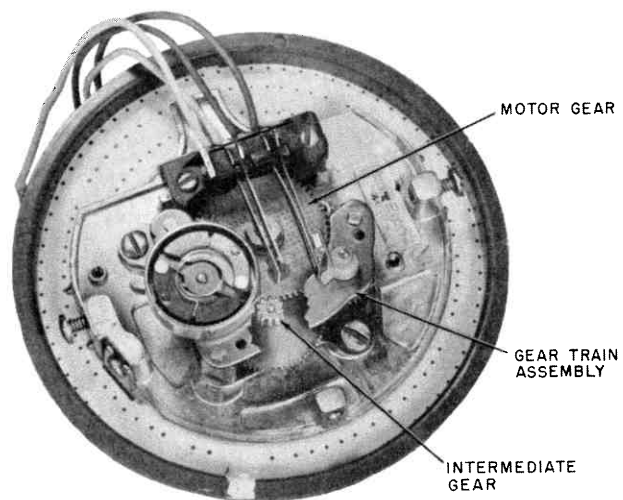

Fig. 23 — 7-Type Dial Gear Mesh

- (6) Very gently rotate fingerwheel back and forth just enough to feel any backlash.
- (7) Rotate fingerwheel to about 3/4 distance of its travel. Repeat steps 4, 5, and 6.

3.33 To adjust gear mesh:

- (1) Loosen screw A (Fig. 27) just enough to allow the elongated slot in the gear train assembly to be moved.

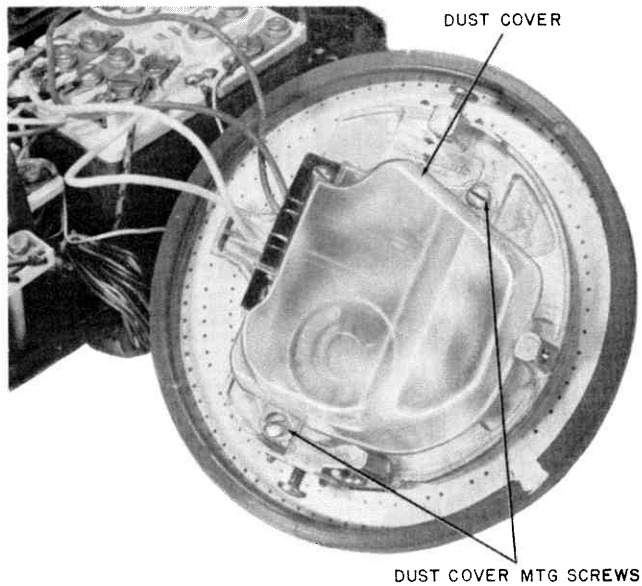

Fig. 24 — 7-Type Dial Removed from Set

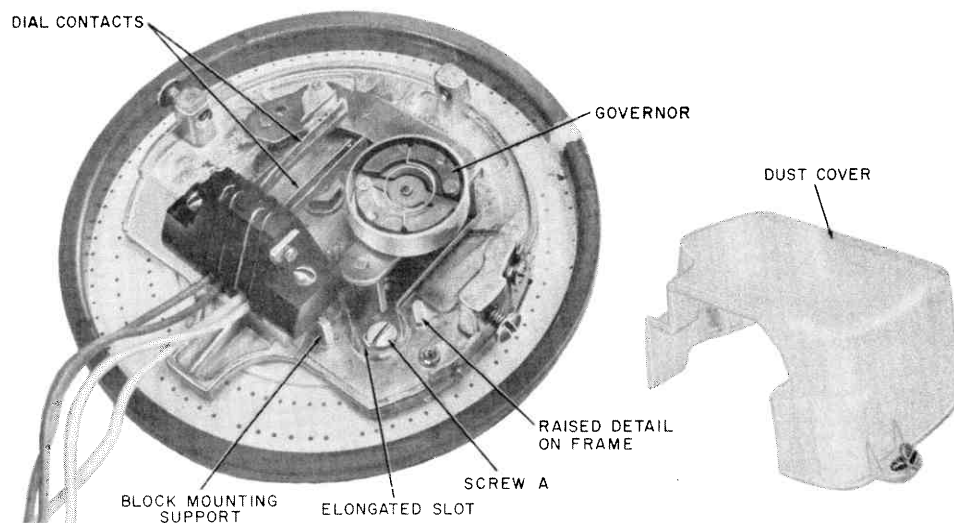

Fig. 25 — 7-Type Dial, Dust Cover Removed

- (2) To tighten gear mesh, place screwdriver blade between raised detail on frame and gear train assembly (Fig. 27). Twist blade enough to slightly move the assembly. Test dial each time the assembly is moved using methods described in steps 4 through 7 in 3.32.

- (3) To loosen gear mesh, place screwdriver blade between contact spring-block mounting support and gear train assembly (Fig. 28). Twist blade enough to slightly move the assembly. Test dial each time the assembly is moved using methods described in steps 4 through 7 in 3.32.

- (4) Tighten screw A when adjustment is completed.
- (5) Dial a series of zeros to test dial.
- (6) If dial still does not operate properly, reassemble dust cover and replace dial.
- (7) If dial operates properly, replace dust cover.
- (8) Reassemble dial.

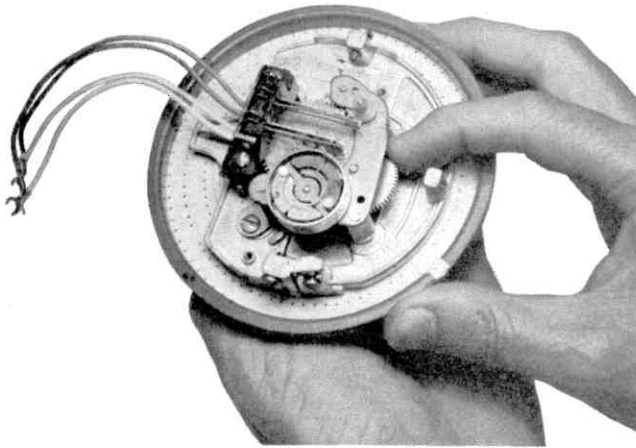

Fig. 26 — Holding Intermediate Gear Immobile

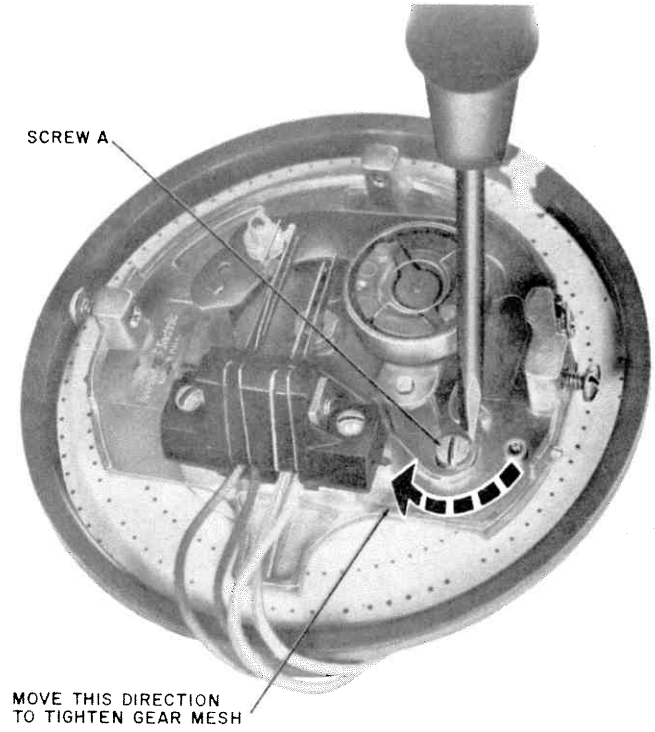

Fig. 27 — Using Screwdriver to Tighten Gear Mesh

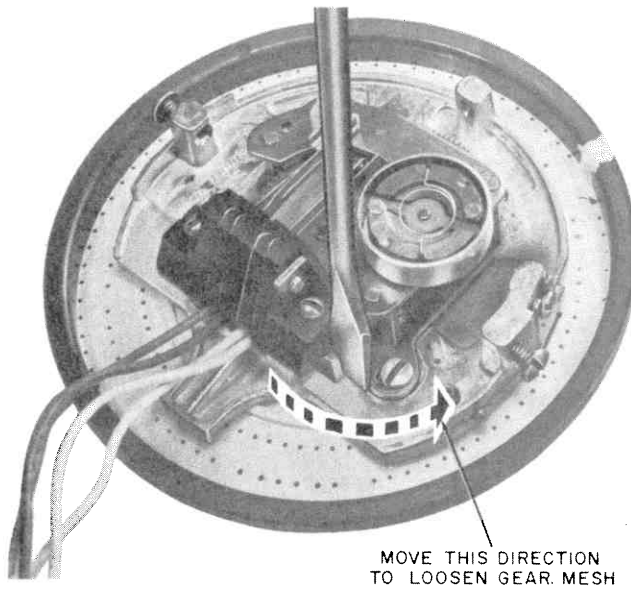

Fig. 28 — Using Screwdriver to Loosen Gear Mesh