

## CENTRALIZED KEY TELEPHONE INSTALLATIONS

### 1. GENERAL

1.01 This section contains information on centralized key telephone installations using color-coded modular backboards, 88-type wiring blocks and 600-series modular panels in equipment rooms, riser closets, apparatus closets, satellite closets, and satellite locations.

1.02 This section is reissued to:

- Add information on 187B1 and 188A1 backboards
- Add information on 88-type wiring blocks and 600-series modular panels
- Include information formerly contained in Section 461-100-101.

Since this reissue covers a general revision, arrows ordinarily used to indicate changes have been omitted.

1.03 This section covers the majority of basic Key Telephone System (KTS) services currently in use in an effort to create a standard centralized KTS installation. In some cases the scheme will not be clearly applicable and local improvisation will be required. In this case, the guidelines should be followed as closely as possible.

1.04 A well-planned terminal arrangement is essential for installation of all KTSs. Proper planning will ensure standard construction practices so craft personnel working on Key Telephone System installations will see the same layouts at all terminals. This planning should result in lower initial installation costs, maintenance expense, and improved housekeeping. The installation should also be planned with expansion in mind, rather than just to accommodate the customer's current demands.

1.05 When planning new installations, close coordination is required between the Architects and Builders Service, Station Installation, Marketing,

and Outside Plant Engineering, to ensure standardization of apparatus and services provided by these groups.

1.06 Certain terms used to describe the standards for cross-connecting, terminating and cabling of KTS installations may be unfamiliar to the user. The following paragraphs define these terms.

(a) **Terminal Room:** Location (usually in the basement) inside a building where the entrance cable from the central office (CO) terminates. The CO pairs are cross-connected to the pairs that radiate throughout the building. PBX, key and/or special equipment may also be terminated in this room.

(b) **Equipment Room:** Location generally used to house PBX equipment. It may also contain KTS apparatus and terminating facilities.

(c) **Apparatus Closet or Room:** A location for terminating the inputs and outputs of CO, PBX, key and special equipment. The equipment is usually located in the apparatus closet. Locating the equipment in the closet provides the following advantages:

- Equipment-operating noise is eliminated from office area.
- Office appearance is improved.
- Work operations cause little disturbance to customer.
- Equipment space is minimized and common equipment can be shared.

(d) **Riser Closets:** Location on each floor where riser cables terminate for further distribution on that floor. A riser closet may also serve as an apparatus or satellite closet.

(e) **Satellite Closet:** Houses terminating facilities for KTS services, stations, and CO/PBX lines. It does not contain KTS apparatus.

### NOTICE

Not for use or disclosure outside the  
Bell System except under written agreement

(f) **Satellite Location:** Serves same function as a satellite closet. It may be a flush-mounted wall cabinet or box, a surface-mounted terminal box, or a terminal facility mounted in some other area.

(g) **Key Telephone Stations:** Multikey telephone sets which are used to receive and initiate calls.

(h) **Key Telephone Systems:** Building block units of station apparatus designed to provide multiline pickup, line lamp signals, common audible signaling, intercom, and auxiliary service. These units are installed on customer premises.

(i) **Service Features:** Categorized as follows:

- Basic line
- Intercom
- Auxiliary

(j) **Basic Line Services:** Include line pickup, line hold, and call status indications in the form of lamp signals for multiple lines appearing at key telephone stations.

(k) **Intercom Service:** Provides internal communication among stations without the need for connections through CO or PBX facilities.

(l) **Auxiliary Services:** Provide special features, such as:

- Exclusion
- Power failure transfer
- Incoming call transfer
- Auxiliary lamp control
- Common audible signals.

- 461-604-102—Connecting Blocks, 66A, B, C and M1-Type, Identification
- 461-608-100—Connecting Blocks and Wiring Blocks, 88-Type
- 518-215-419—Service, 1A2 KTS Panels, 620-, 641-, and 642-Type.

**2. IDENTIFICATION**

**2.01** The backboard and wiring block color scheme presented in this section is a standard plan to be followed when making terminations and cross-connections on customer premises. This plan calls for all inputs and outputs from KTS equipment located in a specific area to appear on one cross-connection field along with the termination of CO/PBX lines and station lines serving that area. There are four classes of lines that require cross-connections. These lines and the color backboard or wiring block field assigned to them are as follows:

BACKBOARD/WIRING BLOCK COLOR	LINES
green	1. Toward central office
blue	2. Toward station sets
red	3. To and from KTS equipment
yellow	4. To and from auxiliary equipment

**Note:** Purple has been designated PBX connections but will not be covered in detail since this section deals primarily with key system installations.

**2.02** This standardized plan allows easy identification of the terminations of the telephone services involved. See Table A for backboard selection and Table B for wiring block selection.

**3. PLANNING**

**3.01** A telephone closet (apparatus or satellite) contains the apparatus necessary to provide telephone service to the area served by the closet. This apparatus may also be housed in an equipment room. See Fig. 15 for a typical layout showing the relationship between closets.

**References**

**1.07** For additional information, refer to the following sections:

- 461-604-100—Connecting Blocks, 66-Type; Tools, Terminating, Adapters and Maintenance

**TABLE A**  
**BACKBOARD SELECTION**

CODE	COLOR	SEE FIG.	MATERIAL	E/W 89B BRACKETS	E/W 66B4-25 CONNECTING BLOCKS	E/W DISTRIBUTING RINGS P-43X237	MAXIMUM NUMBER TERMINATIONS (PAIRS) USING CONNECTING BLOCKS		
							66M1-25*	66M1-50*	66B4-25
183A1	BLUE	1	METAL	4			100	200	
183A2	GREEN			4			100	200	
183A5	YELLOW			4			100	200	
183B1	BLUE	2		8			200	400	
183B2	GREEN			8			200	400	
183B3	RED			8			200	400	
183B5	YELLOW			8			200	400	
184A1	RED	3				2	6		50
184B1	RED	4				4	12		100
184B2	RED	5				4			100
185A1	YELLOW	6	PARTICLE BOARD			6			
187B1	WHITE	7	METAL			16			
188A1†	WHITE	8	METAL			4			

\* Connecting blocks must be ordered separately.

† Use with 88-type wiring blocks only.

**3.02** Each closet should meet the following requirements:

- Walls to be used to mount equipment should be lined with 3/4-inch plywood.
- Walls to be used to mount backboards should be equipped with 3/4-inch furring strips spaced on 10-inch horizontal centers starting even with the top of the top backboard.

**Note:** 88-type wiring blocks may be mounted directly on the wall using fasteners appropriate for the type of wall surface.

- A minimum of one ceiling light with a wall switch located near the door.
- A 20-ampere circuit with two 110-volt duplex receptacles.

**3.03** For optimum working conditions, one closet should be provided for each 10,000 square feet of usable floor space. The cabling should be laid out so that all cable runs between the apparatus closet and the key equipment are as short as possible. Loop resistance should not exceed 50 ohms or approximately 1000 feet of 24-gauge cable.

TABLE B

## 88-TYPE WIRING BLOCKS

CODE (NOTE 1)	COLOR (NOTE 2)	MAX. NO. OF TERMINATIONS (PAIRS)	SEE FIG.
88AW1-100	White	100	9
88AW1-300		300	10
88BW1-25		25*	11
88BW1-25C †		25*	12
88BW1-75		75†	13
88BW1-75C ‡		75†	

*Note 1:* 3- or 5-pair 88-type connecting blocks (Fig. 14) must be installed to provide for cross-connects.

*Note 2:* Color-coded designation strips are used to determine application of the wiring blocks as follows:

- Green field — 188AG1-100 (includes cable pair count)
- Yellow field — 188BY1-100
- Red field — 188BR1-100 or 188CR1-25
- Blue field — 188AB1-100 (for tie cables — includes cable pair count)
- 188BB1-100 (for key stations)

\* Five multiples of one 25-pair cable.

† Five multiples of three 25-pair cables.

‡ Factory-wired with a 5-foot length of connector cable.

**3.04** See Tables C and D to estimate closet space required for KTS apparatus.

**3.05** See Tables E and F to estimate horizontal wall space needed to mount modular backboards and 88-type wiring blocks in apparatus closets and satellite closets, respectively.

**3.06** Fig. 16 shows a typical arrangement of modular apparatus installed in an apparatus closet.

**3.07** The 88-type wiring blocks may be used in all indoor applications currently using 66-type connecting blocks and modular backboards. The 88-type wiring blocks provide the following advantages:

- Require less space
- Shorter jumpers and easier jumper tracing
- Easier pair identification for cross-connections.

**3.08** Fig. 17 shows a typical arrangement of 88-type wiring blocks installed in an apparatus closet.

**3.09** The 600-series modular panels may be intermixed in the RED terminal field with the 184B-type backboards. See Fig. 18.

#### 4. INSTALLATION

##### *Backboards—183- and 184-Type*

**4.01** The cornerstone of the terminating field is the green backboard on which the CO/PBX lines terminate. The minimum number of green backboards placed will be two, one above the other. The bottom of the lower backboard should be 12 inches off the floor and the left edge placed at a predetermined mark. See Fig. 19 and 20 for the

**TABLE C**  
**1A2 KEY TELEPHONE SYSTEM APPARATUS MOUNTING REQUIREMENTS**

AREA SERVED IN SQUARE FEET	NUMBER OF APPARATUS MOUNTINGS (7 ft by 3 ft) *	FLOOR AREA IN SQUARE FEET REQUIRED IN CLOSET (SEE TABLE D)	LINEAR FEET OF LATERAL WALL SPACE REQUIRED IN CLOSET
Up to 18,000	1	12	4
18,000 to 36,000	2	16 or 32 <sup>†</sup>	8

\*For 1A1 key equipment use, one 7-foot apparatus mounting is required for up to 9000 sq. ft. of served floor area. For more than 9000 sq. ft., double the number of apparatus mountings.

<sup>†</sup>Required when apparatus mountings are located so that swing-open gate clearance space cannot be used jointly by both apparatus mountings.

**TABLE D**  
**CLOSETS FOR 1A2 KEY TELEPHONE SYSTEM APPARATUS MOUNTINGS**

CLOSET-TYPE	MINIMUM DEPTH	REQUIREMENTS/REMARKS
Walk-in	3 ft	Provides clearance for swing-open apparatus mounting gate One wall can be used For shallow closet (1-1/2 ft min.), unobstructed access to corridor or office area for swing open gates
Walk-in	4 ft	If two adjacent walls or opposite walls are used for apparatus mounting
Walk-in	5 ft	If two opposite walls and common adjacent walls are used for apparatus mounting
Walk-in	4 ft	If two opposite walls only are used for apparatus mounting
Shallow Apparatus	1-1/2 ft (2-1/2 ft max.)	Minimum door height: 6 ft 8 in. Minimum door width: 3 ft with center post eliminated between doors Minimum ceiling height: 7-1/2 ft, to accept 85-inch apparatus mounting
Walk-in	3 ft	Minimum door height: 6 ft 8 in. Minimum door width: 3 ft Minimum ceiling height: 7-1/2 ft, to accept 85-inch apparatus mounting



basic mounting patterns for apparatus closets and satellite closets, respectively. Table G shows the sequence for mounting 66-type backboards in a standard configuration. Table H provides a similar sequence for 88-type apparatus.

#### *Wiring Blocks—88 Type*

**4.02** The arrangement of the wiring blocks on a wall depends on the size and type of installation. A large KTS installation will use a horizontal arrangement of wiring blocks as shown in Fig. 21. A small KTS installation may use a vertical arrangement of wiring blocks as shown in Fig. 22.

**4.03** In general, the color coding covered in 2.01 and the mounting patterns shown in Fig. 19 and 20 also apply to the 88-type wiring blocks.

#### *600-Series Modular Panel*

**4.04** The 600-series modular panels may be intermixed with 184B-type connecting blocks anywhere in the RED terminal field as shown in Fig. 23 and 24.

### **5. WIRING PATTERNS**

**5.01** When outside plant, apparatus, and station cables have been permanently terminated, future installation and service changes will be accomplished by using jumpers.

**5.02** Fig. 23 and Table I show jumper patterns for an apparatus closet which directly serves stations.

**5.03** Fig. 24 and Table J show jumper patterns for an apparatus closet which directly serves two satellite closets.

TABLE E

## BACKBOARD AND WIRING BLOCK SPACE ESTIMATION FOR APPARATUS CLOSET

BACKBOARD OR DESIG STRIP COLOR	SPACE FACTORS		SQUARE FOOTAGE OF FLOOR AREA BEING SERVED				
			1000	1500	2000	5000	10,000
GREEN	Two 183A2 or one 183B2 backboards or one 88AW1-300 wiring block will accommodate normal outside plant (CO) needs.						
YELLOW	One 185A1 backboard or one 88AW1-100 wiring block is normally adequate for auxiliary services. When special requirements are known, space must be provided in the yellow field.						
BLUE	A	Stations (sq. ft. floor area served by apparatus closet/100 = A)	10	15	20	50	100
	B	CALL DIRECTOR <sup>®</sup> tel sets (A/20 = B)	0	0	1	3	5
	C	Key tel sets (A - B = C)	10	15	19	47	95
	D	Number of cable conductor pairs per CALL DIRECTOR (75 x B = D)	0	0	75	225	375
	E	Number of cable conductor pairs for key tel sets (25 x C = E)	250	375	475	1175	2375
	F	Total number of pairs for stations (D + E = F)	250	375	550	1400	2750
	G	Stations (50% of total sq. ft. floor area to be served by satellite closet/100 = G)	5	8	10	25	50
	H	Number of cable conductor pairs for key sets (G x R = H)*	20	32	40	100	200
	I	Number of cable conductor pairs for miscellaneous (H x 10/100 = I)	2	3	4	10	20
	J	Total number of pairs in tie cable to satellite (H + I = J)	22	35	44	110	220
	AA	Stations (sq. ft. served by other app. closet/100 = AA)	10	15	20	50	100
	K	Total number of pairs in tie cable between app. closets ([A + AA] x 15/100 x R = K)	12	18	24	60	120
L	Total pairs for blue backboards (F + J + K = L) †	284	428	618	1570	3090	



TABLE E (Cont)

BACKBOARD AND WIRING BLOCK SPACE ESTIMATION FOR APPARATUS CLOSET

BACKBOARD OR DESIG STRIP COLOR	SPACE FACTORS		SQUARE FOOTAGE OF FLOOR AREA BEING SERVED				
			1000	1500	2000	5000	10,000
BLUE (Cont)	Number of 183A1 backboards, L/200 pairs per 183A1		2	3	4	8	16
	Number of 183B1 backboards, L/400 pairs per 183B1		1	2	2	4	8
	Number of 88AW1-100 backboards, L/100 pairs per 88AW1-100		3	5	7	16	31
	Number of 88AW1-300 backboards, L/300 pairs per 88AW1-300		1	2	3	6	11
RED	A	Stations served from apparatus closet	10	15	20	50	100
	M	Lines (A/1 station per line = M)	10	15	20	50	100
	Number of 184A1 backboards, M/10 lines per 184A1		1	2	2	5	10
	Number of 184B1 backboards, M/20 lines per 184B1		1	1	1	3	5
	Number of 88BW1-25 wiring blocks, M/5 lines per 88BW1-25		2	3	4	10	20
	Number of 88BW1-75 wiring blocks, M/15 lines per 88BW1-75		1	1	2	4	7
HORIZONTAL CLOSET SPACE REQUIRED‡	$\frac{184A1 \times 8.5 + 8.5}{12}$		1.4	2.2	2.2	4.25	7.8
	$\frac{184B1 \times 17 + 8.5}{12}$		2.2	2.2	2.2	5.0	7.8
	$\frac{(88BW1-25)}{6} \times \frac{10.75}{12} \S$		0.9	0.9	0.9	1.8	3.6
	$\frac{(88BW1-75)}{2} \times \frac{10.75}{12} \S$		0.9	0.9	0.9	1.8	3.6

\* R = (4 pair per line/1 = 4 (ratio assumed to be greater than one station per line).

† For only one apparatus closet and no satellite closets, delete J and K; then L = F.

‡ Total required horizontal wall space is determined by the number of red backboards or wiring blocks times the width, plus the width of the yellow backboards or wiring blocks to be used.

§ Raise this result to next highest whole number. The 6 and 2 in the denominator result from a maximum of 6 (100 pairs) and 2 (300 pairs) wiring blocks per column.

TABLE F

## BACKBOARD AND WIRING BLOCK SPACE ESTIMATION FOR SATELLITE CLOSET

BACKBOARD OR DESIG STRIP COLOR*	SPACE FACTORS		SQUARE FOOTAGE OF FLOOR AREA BEING SERVED				
			1000	1500	2000	5000	10,000
BLUE	A	Stations (sq. ft. floor area served by satellite closet/100 = A)	10	15	20	50	100
	B	CALL DIRECTOR® tel sets (A/20 = B)	0	0	1	3	5
	C	Key tel sets (A - B = C)	10	15	19	47	95
	D	Number of cable conductor pairs per CALL DIRECTOR (75 x B = D)	0	0	75	225	375
	E	Number of cable conductor pairs per key tel set (25 x C = E)	250	375	475	1175	2375
	F	Total number of pairs for satellite (D + E = F)	250	375	550	1400	2750
		Number of 183A1 backboards, F/200 pairs per 183A1	2	2	3	7	14
		Number of 183B1 backboards, F/400 pairs per 183B1	1	1	2	4	7
		Number of 88AW1-100 wiring blocks, F/100 pairs per 88AW1-100	3	4	6	14	28
		Number of 88AW1-300 wiring blocks, F/300 pairs per 88AW1-300	1	2	2	5	10
RED	AA	Stations served from satellite closet	10	15	20	50	100
	G	Lines (AA/1 station per line = G)	10	15	20	50	100
	H	Number of conductor pairs in tie cable (G x R = H)†	40	60	80	200	400
		Number of 184A1 backboards, H/50 pairs per 184A1	1	2	2	4	8
		Number of 184B1 backboards, H/100 pairs per 184B1	1	1	1	2	
		Number of 88BW1-25 wiring blocks, H/25 pairs per 88BW1-25	2	3	4	8	16
		Number of 88BW1-75 wiring blocks, H/75 pairs per 88BW1-75	1	1	2	3	6
	HORIZONTAL CLOSET SPACE REQUIRED‡		$\frac{184A1 \times 8.5 + 8.5}{12}$	1.4	2.2	2.2	3.6
		$\frac{184A1 \times 17 + 8.5}{12}$	2.2	2.2	2.2	3.6	6.4
		$\frac{88BW1-25}{6} \times \frac{10.75}{12} §$	0.9	0.9	0.9	1.8	2.7
		$\frac{88BW1-75}{2} \times \frac{10.75}{12} §$	0.9	0.9	0.9	1.8	2.7

\* Green and yellow backboards are usually not required in a satellite closet.

† R = (4 pairs/line) = 4 (in tie cable).

‡ Total required horizontal wall space is determined by the number of red backboards or wiring blocks to be used.

§ Raise this result to the next highest whole number. The 6 and 2 in the denominator result from a maximum of 6 (100 pairs) and 2 (300 pairs) wiring blocks per column.

**TABLE G**  
**INSTALLATION SEQUENCE – 180 SERIES BACKBOARDS**

COLOR AND CODE	PROCEDURE
Green 183A2 or 183B2	<p>First backboard  Installed by construction forces in lower left corner 1 foot above floor. Horizontal location selected jointly by outside plant engineer and service foreman.</p> <p>Second backboard  Above first backboard, bottom butted to first backboard.</p>
Yellow 185A1‡	Above second GREEN backboard, bottom butted to GREEN backboard.
Blue 183A1 or 183B1	<p>2 high – lower BLUE 1 foot from floor.</p> <p>Left side of the first two backboards (2-high) butted to GREEN backboards.</p>
White 187B1*	Butt left side of first backboard to YELLOW; extend required number of backboards horizontally using only one row.
Red 184B1 or 184B2†‡	<p>Top row:  Butt left side of first backboard to YELLOW; extend required number of backboards horizontally using only one row.</p> <p>If inadequate horizontal space, place second row of RED above first row of RED.</p> <p>If inadequate height, place RED backboards in middle row, at end, inverted. Never place RED backboard in bottom row.</p>

\* Use with 184B2 backboard. See Fig. 9.

† Use with 187B1 backboard. See Fig. 9.

‡ Installations involving 600-series modular panels eliminate the need for some or all the backboards in the YELLOW and RED fields (see Fig. 18).

TABLE H

## INSTALLATION PROCEDURE – 88-TYPE WIRING BLOCKS

CODE (NOTE)	PROCEDURE
88AW1-100 or 88AW1-300 (Green Field)	<p><i>First Wiring Block:</i></p> <p>Installed by construction forces on the left side of the installation with the top of the block 55 inches above the floor. Horizontal location selected jointly by outside plant engineer and service foreman.</p> <p><i>Second Wiring Block (if required):</i></p> <p>Below the first wiring block; top butted to first block.</p>
188A1 Backboard (White)	Directly above the first GREEN wiring block. Extend, as required, horizontally to the right using only one row.
88AW1-100 (Purple Field)	Purple field <i>if required</i> is butted directly above the WHITE backboard. YELLOW would then go above PURPLE.
88AW1-100 (Yellow Field)	Directly above the 188A1 WHITE backboard that is located above the GREEN wiring blocks. PURPLE, when required, is butted to the WHITE backboard.
88BW1-25 or 88BW1-75 (Red Field)	88BW1-25 may be 6 high and 88BW1-75 may be 2 high. Located above the 188A1 backboard and to the right of the YELLOW and/or PURPLE wiring blocks. Left side butted to YELLOW and/or PURPLE wiring blocks.
88AW1-100 or 88AW1-300 (Blue Field)	88AW1-100 may be 12 high and 88AW1-300 may be 4 high. Located below the 188A1 backboards and to the right of the GREEN wiring blocks. Left side butted to GREEN wiring blocks. The area below the GREEN wiring blocks may be used, particularly for tie cables.

*Note:* All wiring blocks are manufactured in white plastic. The color of the field is determined by the use of appropriately colored designation strips. See Table B.

**TABLE I**  
**JUMPERS USED IN A TYPICAL APPARATUS CLOSET WHICH**  
**DIRECTLY SERVES STATIONS**

LINE PURPOSE	ARROW NO. (FIG. 23)	JUMPERS
CO/PBX	1	<b>2-conductor:</b> from GREEN field (line pickup) to RED field (key equipment termination)
Key telephone button with basic line service	2	<b>6-conductor:</b> from RED field (line service termination) to BLUE field (key telephone set termination)
	3	<b>2-conductor (for ringing):</b> from YELLOW field (auxiliary apparatus) to RED field (key equipment termination)
Auxiliary and dial inter-communication service	4	<b>2-conductor:</b> from YELLOW field (auxiliary apparatus) to BLUE field (key telephone set terminations)

**Note:** Use F cross-connect wire for jumpers.

**TABLE J**  
**JUMPERS USED IN AN APPARATUS CLOSET WHICH DIRECTLY SERVES TWO**  
**SATELLITE CLOSETS**

LINE PURPOSE	ARROW NO. (FIG. 24)	JUMPERS
CO/PBX	1	<b>2-conductor:</b> from GREEN field (line pickup) to RED field (key equipment termination)
Key telephone button with basic line service (to satellite closet)	2	<b>6-conductor:</b> from RED field (line service termination) to BLUE field (tie cable termination)  <b>2-conductor (for ringing):</b> from RED field (line service termination) to BLUE field (tie cable termination) or from RED field (line service termination) to YELLOW field (auxiliary services) to BLUE field (tie cable termination)
	3	<b>6-conductor:</b> from RED field (line service termination) to BLUE field (station set termination)  <b>2-conductor:</b> from RED field (line service termination) to BLUE field (station set termination)

**Note:** Use F cross-connect wire for jumpers.

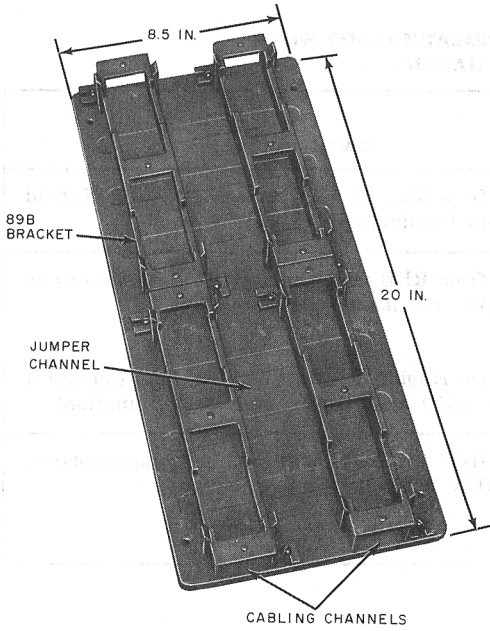

Fig. 1—183A-Type Backboard

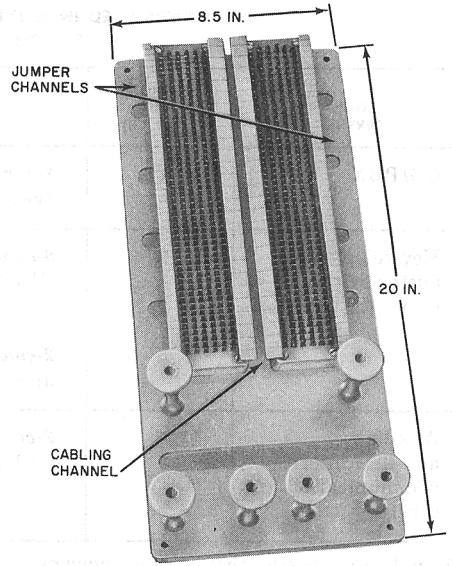

Fig. 3—184A1 Backboard

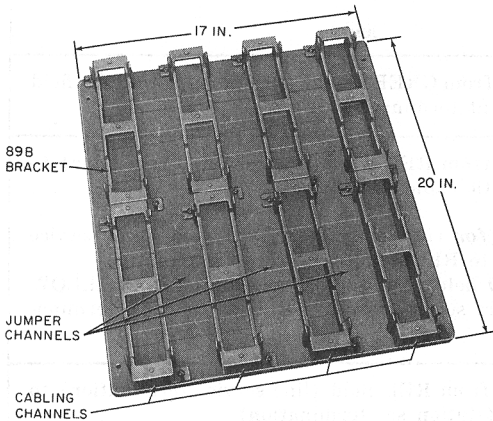

Fig. 2—183B-Type Backboard

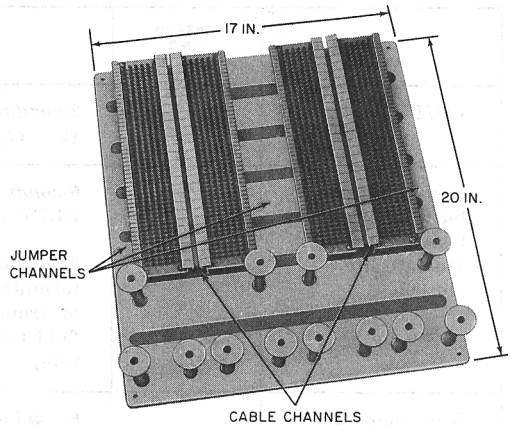
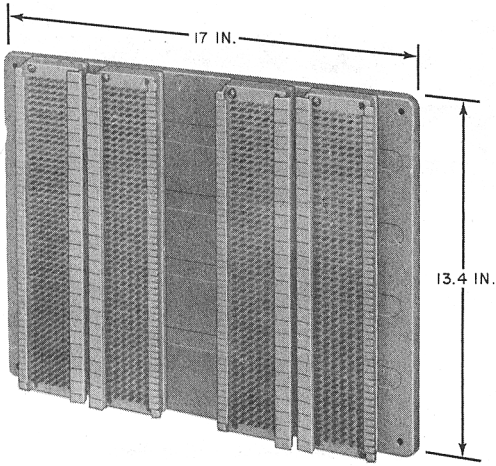
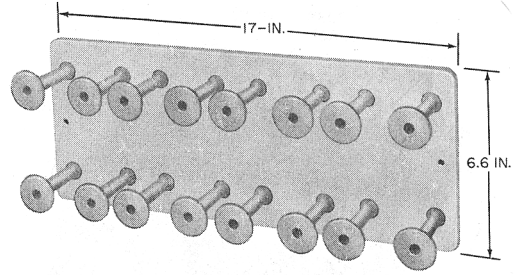

Fig. 4—184B1 Backboard



**Fig. 5—184B2 Backboard**



**Fig. 7—187B1 Backboard**

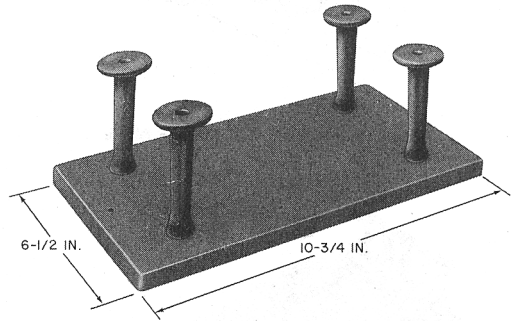

**Fig. 8—188A1 Backboard**

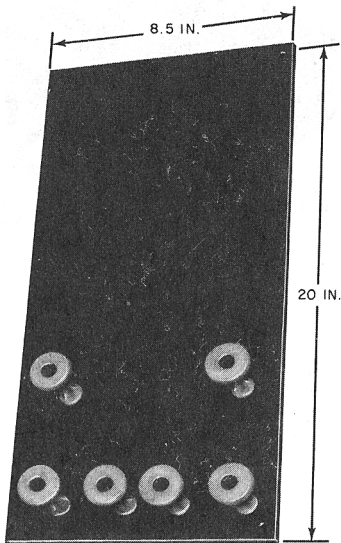

**Fig. 6—185A1 Backboard**

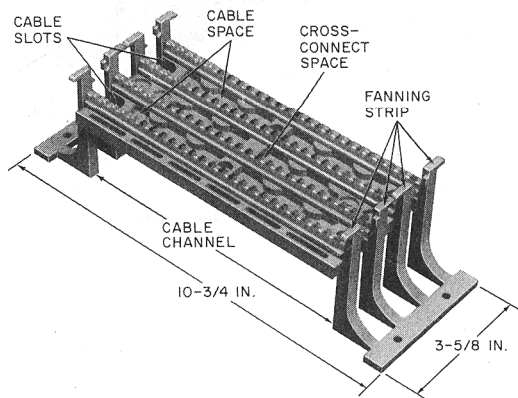

**Fig. 9—88AW1-100 Wiring Block**

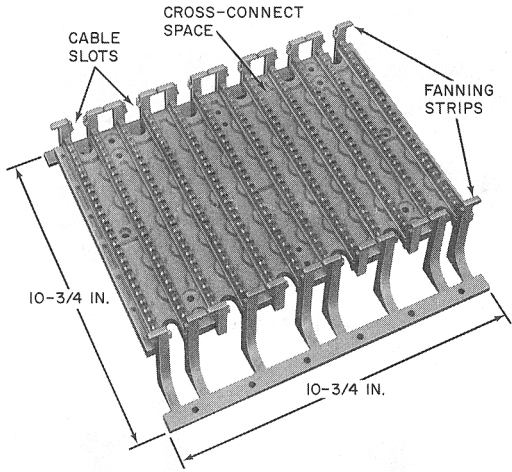

Fig. 10—88AW1-300 Wiring Block

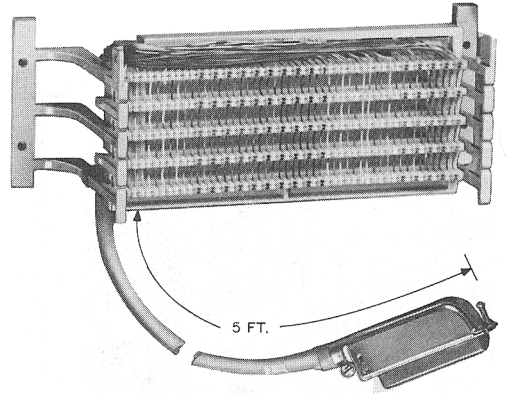

Fig. 12—88BW1-25C Wiring Block

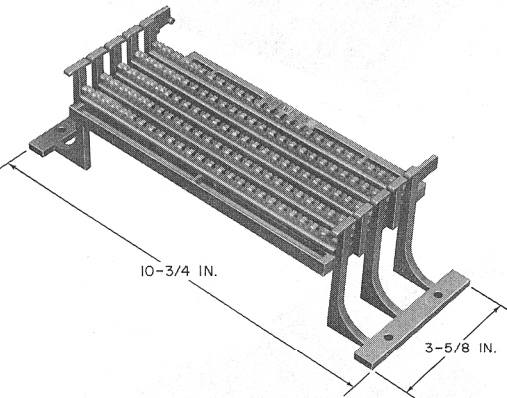

Fig. 11—88BW1-25 Wiring Block

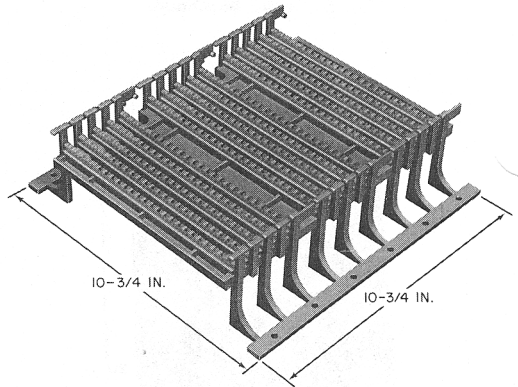

Fig. 13—88BW1-75 Wiring Block



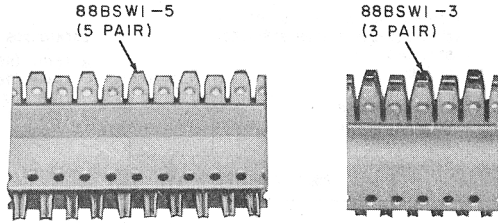

Fig. 14—88BSW1-5 and 88BSW1-3 Connecting Blocks

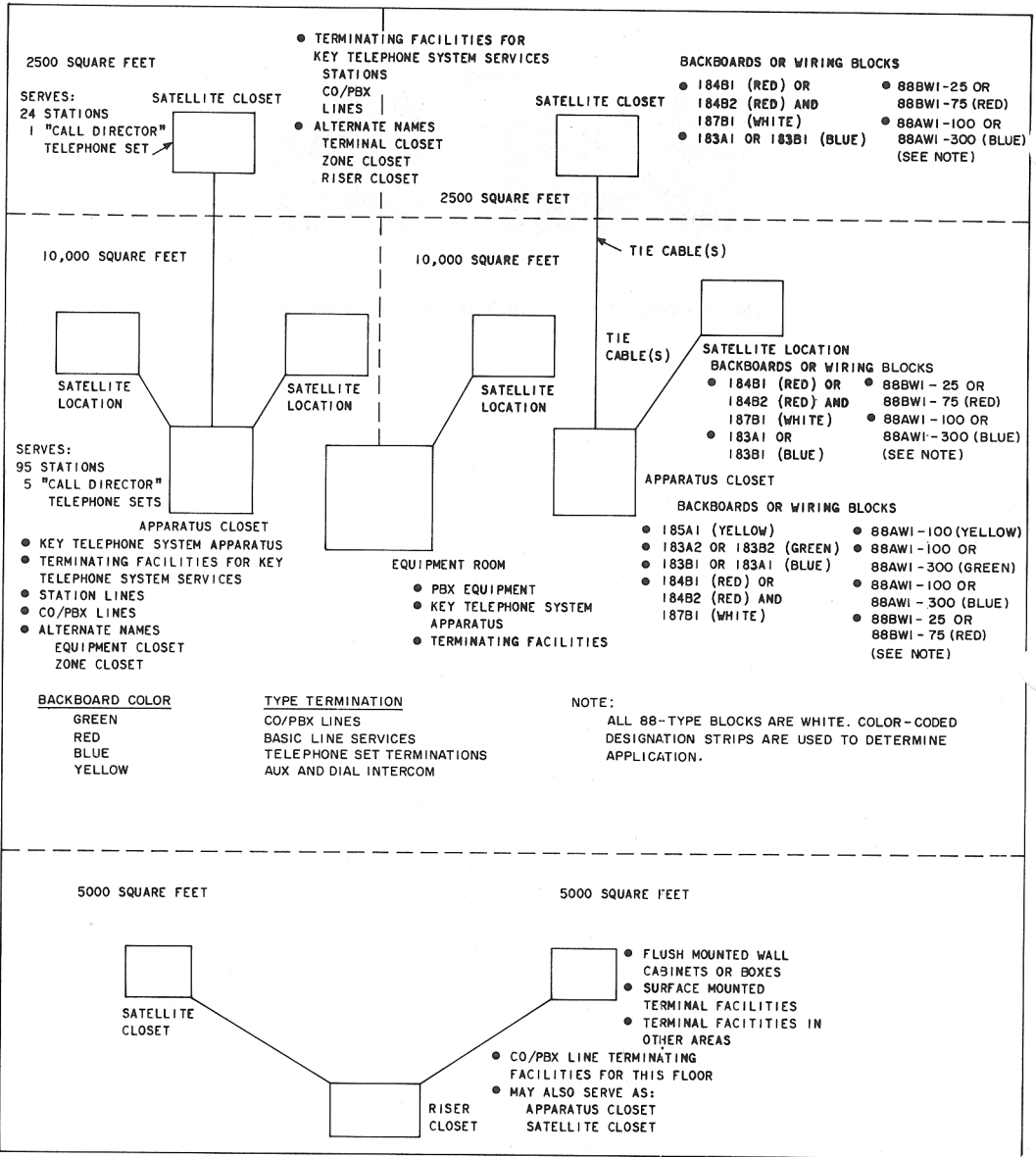

Fig. 15—Typical Floor Plan Showing Specific Telephone Closet Function and Relation

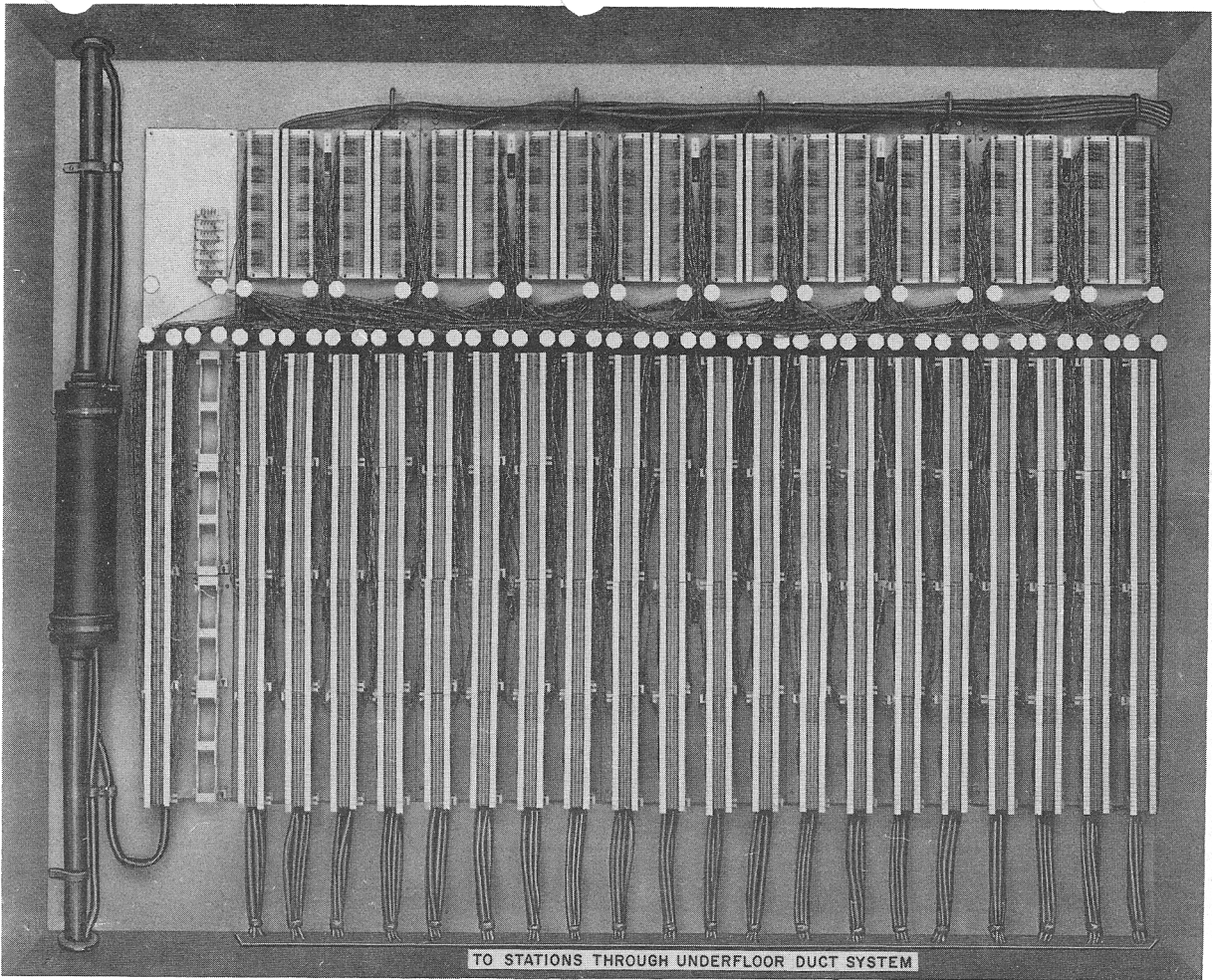

Fig. 16—Typical Apparatus Closet Arrangement Using Modular Apparatus

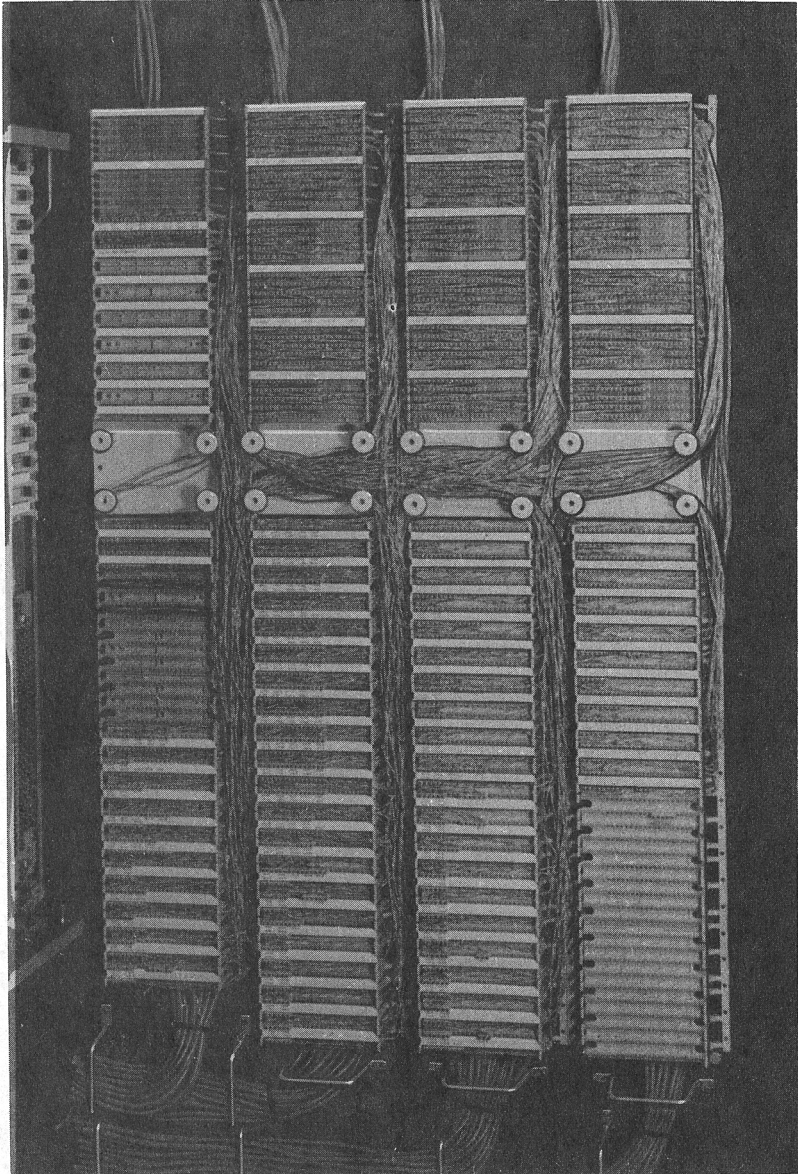
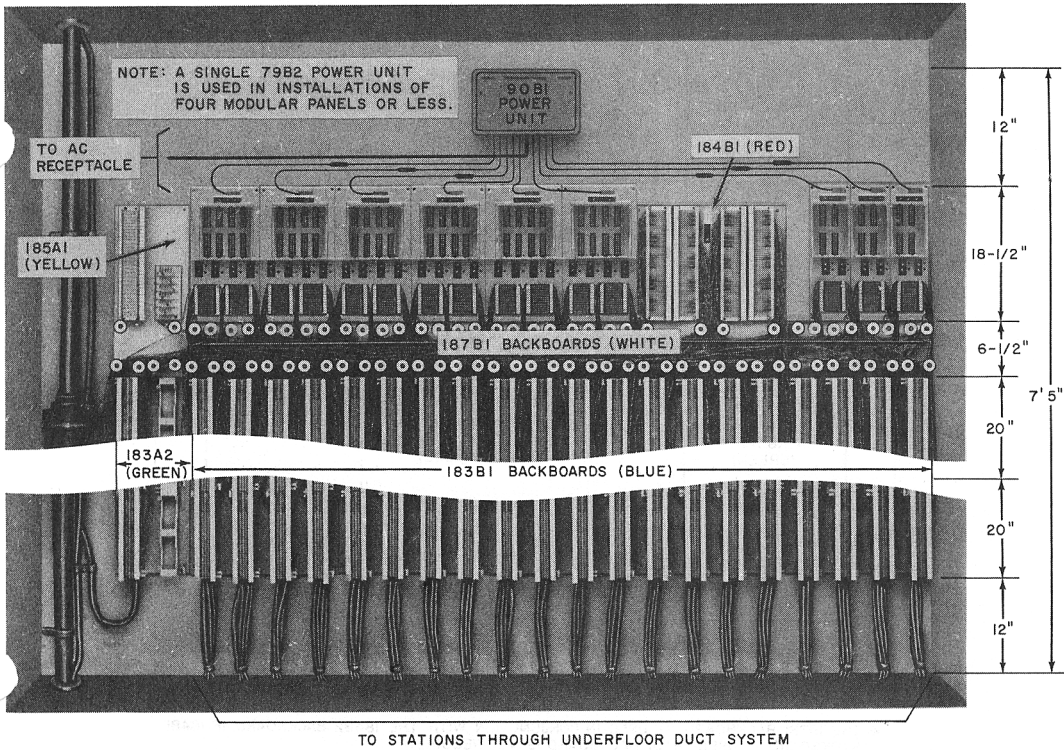
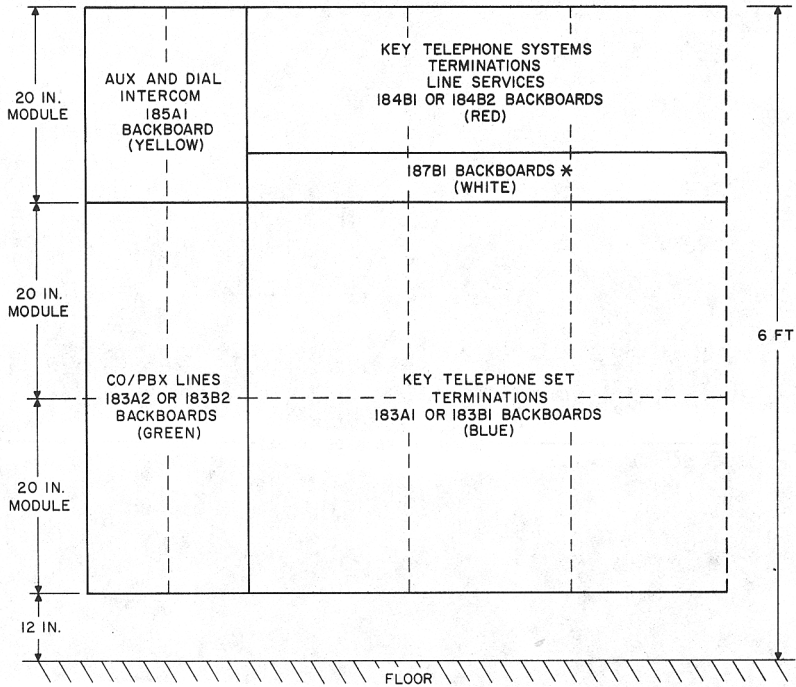

Fig. 17—Typical Apparatus Closet Arrangement Using 88-Type Wiring Blocks

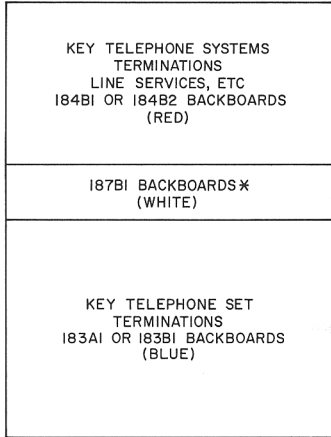

**Fig. 18—Typical Centralized Terminal Field Arrangement Using 180-Type Backboards, 66-Type Connecting Blocks, and 600-Series Modular Panels**



\* THE 187B1 BACKBOARD IS USED IN CONJUNCTION WITH THE 184B2 BACKBOARD. IF 184B1 BACKBOARD IS USED, 187B1 BACKBOARD IS NOT REQUIRED.

**Fig. 19—Apparatus Closet, Basic Pattern, Using 180-Type Backboards**



\* THE 187BI BACKBOARD IS USED IN CONJUNCTION WITH THE 184B2 BACKBOARD. IF 184BI BACKBOARD IS USED, 187BI BACKBOARD IS NOT REQUIRED.

**Fig. 20—Satellite Closet, Basic Pattern, Using 180-Type Backboards**

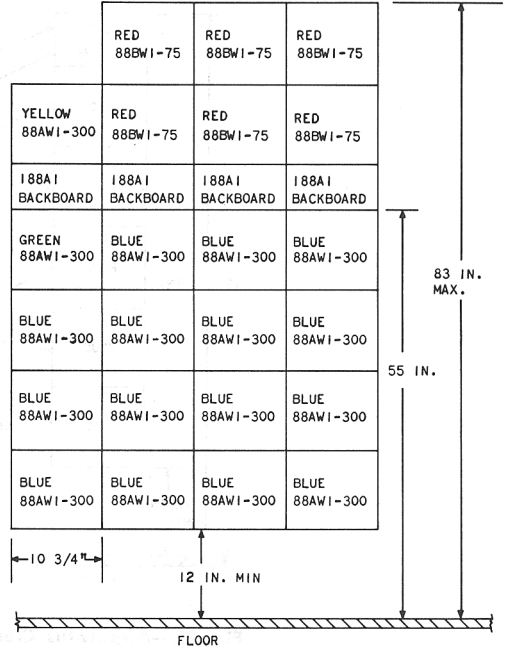

NOTE:  
 FOR SATELLITE CLOSET, DELETE GREEN  
 AND YELLOW WIRING BLOCKS. THIS  
 ARRANGEMENT WILL SERVE 180  
 KEY STATIONS.

**Fig. 21—Apparatus Closet, Basic Pattern, Using 88-Type Wiring Blocks—Horizontal Arrangement**

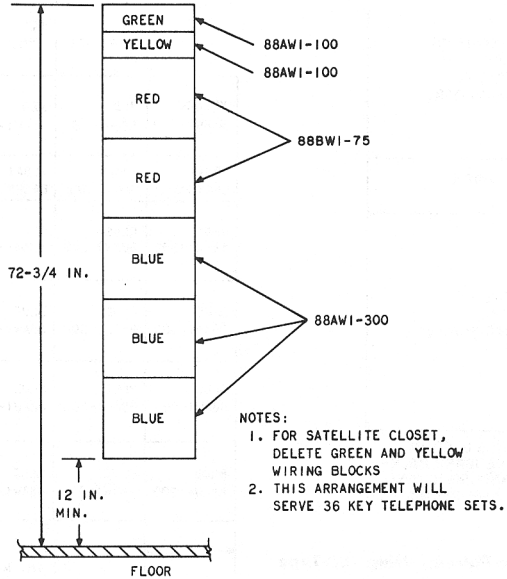

**Fig. 22—Apparatus Closet, Basic Pattern, Using 88-Type Wiring Blocks—Vertical Arrangement**



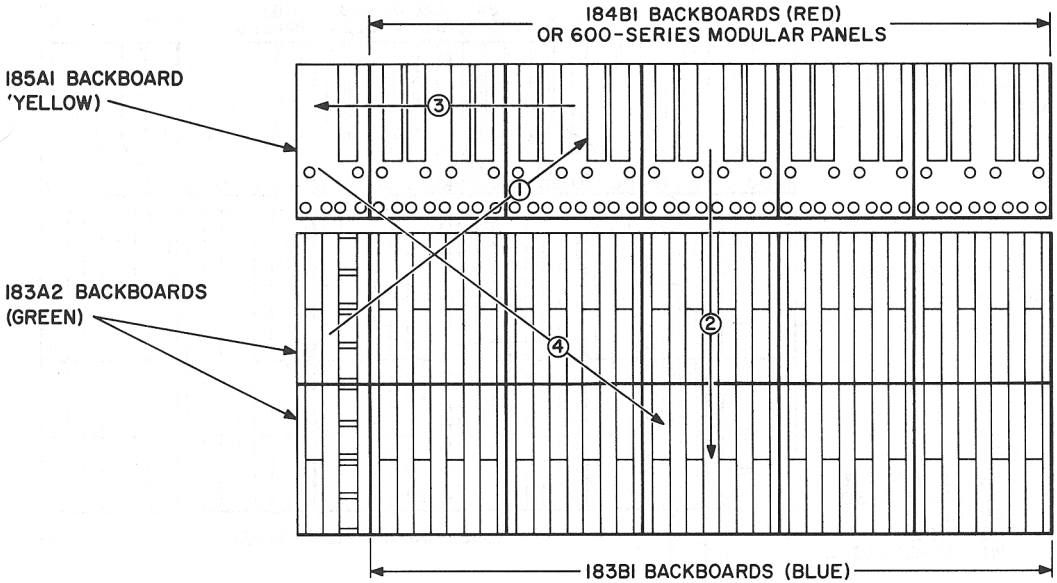

NOTE:  
 THESE JUMPER PATTERNS ALSO APPLY  
 TO 88-TYPE WIRING BLOCKS.

**Fig. 23—Jumper Patterns for an Apparatus Closet Which Directly Serves Stations**

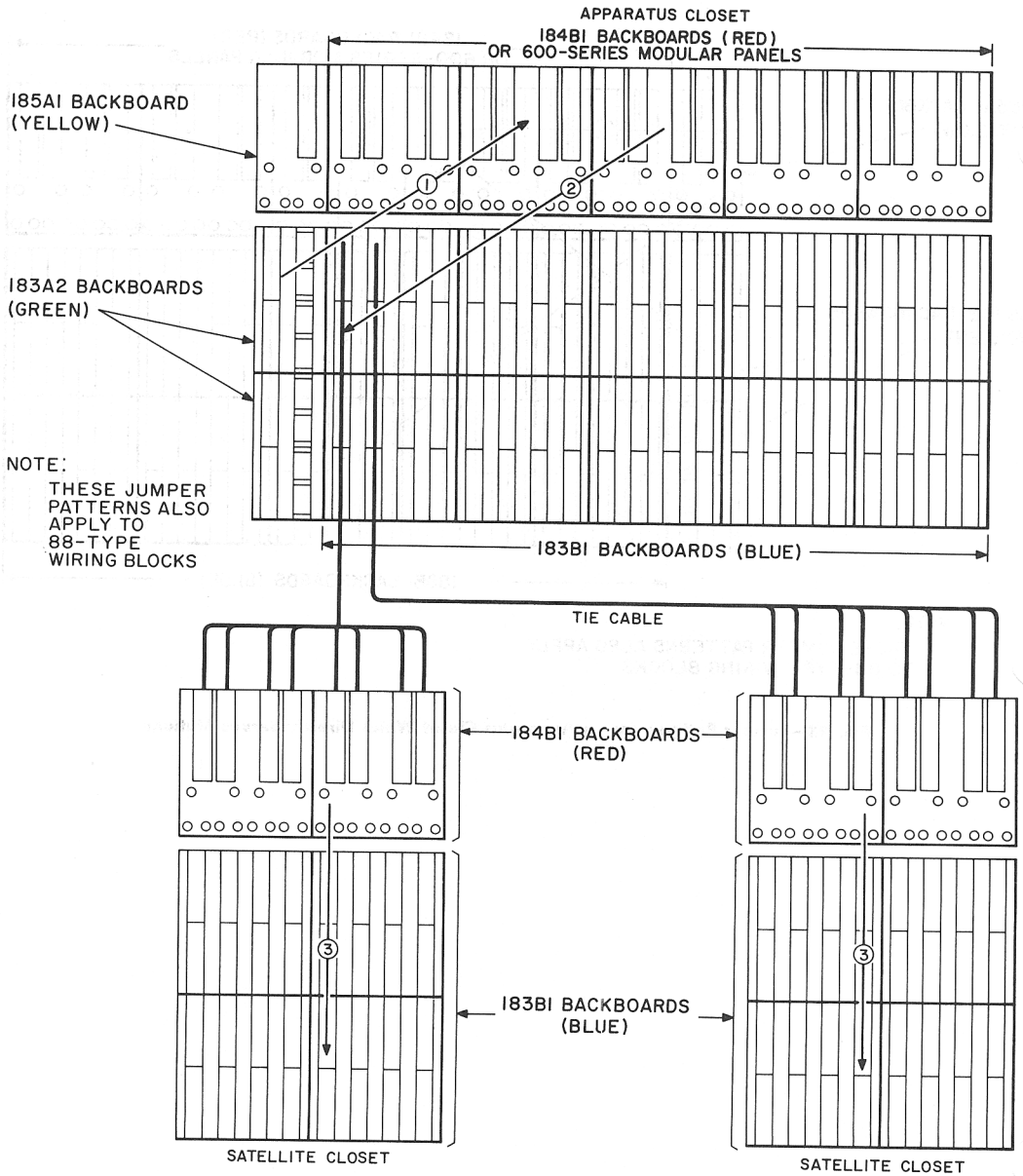

Fig. 24—Jumper Patterns for an Apparatus Closet Which Directly Serves Two Satellite Closets