

“PICTUREPHONE®” SERVICE (PHASE 0)
SINGLE LINE SERVICE AND 1P2 KEY TELEPHONE SYSTEM ARRANGEMENTS
USING 2C VIDEO TELEPHONE STATION
GENERAL DESCRIPTION

| | PAGE | | PAGE |
|---|------|---|------|
| 1. GENERAL | 1 | 2C VIDEO TELEPHONE STATION | 20 |
| 2. PRINCIPAL FEATURES | 2 | 1P2 KEY TELEPHONE SYSTEM | 20 |
| 2C VIDEO TELEPHONE STATION | 2 | A. Single Group Line Service | 20 |
| SINGLE LINE SERVICE | 4 | B. Single Link Intercom Service | 21 |
| 1P2 KEY TELEPHONE SYSTEM | 4 | C. Multigroup Line Service | 22 |
| A. Type of Station | 4 | D. 2- or 3-Link Intercom Service | 24 |
| B. Type of Service | 4 | 4. TESTS AND MAINTENANCE | 25 |
| C. Ringing Options | 8 | 2C VIDEO TELEPHONE STATION | 25 |
| D. Type of Mountings | 8 | 1P2 KEY TELEPHONE SYSTEM | 25 |
| 650A-Type Key Service Unit | 8 | 5. VIDEO LOOP ALIGNMENT | 25 |
| J53051A Equipment Bay | 11 | 6. REFERENCES | 25 |
| J53051B Equipment Bay | 11 | 1. GENERAL | |
| J53051C Equipment Bay | 14 | 1.01 This section describes PICTUREPHONE® service using the 2C Video Telephone Station in conjunction with single line service and 1P2 Key Telephone System Arrangements. | |
| External Mountings for KTUs | 14 | 1.02 This section is reissued to add information on PICTUREPHONE Intercom Conference Key System (PICKS) which is a voice switched conferencing arrangement for the 2- or 3-link intercom. Changes or additions in the body of Table A are shown by shaded areas. | |
| E. Key Telephone Units | 15 | 1.03 This issue of the section is based on the SDs listed in Part 6. If this section is to be used with equipment or apparatus reflecting later issues of the drawings, reference should be | |
| F. Video-Audio Station Bridging | 19 | | |
| G. Add-on Conference | 19 | | |
| H. Add-on Transfer | 19 | | |
| I. PICTUREPHONE® Intercom Conference Key System (PICKS)† | 19 | | |
| 3. OPERATING FEATURES | 20 | | |

SECTION 518-800-100

made to the SDs to determine the extent of the changes and the manner in which the section may be affected.

1.04 PICTUREPHONE service adds video capability to existing telephone service, thus providing the customer with the ability to "see" as well as "talk".

1.05 PICTUREPHONE service requires three associated pairs of conductors: a video quad and an audio (talk) pair. The video quad consists of a pair for receiving (incoming) video and a pair for transmitting (outgoing) video.

1.06 The serving CO, Centrex, or PBX must be modified for wideband switching and TOUCH-TONE® calling. Wideband switching provides the capability of switching the one MHz video frequency band.

1.07 The 2C Video Telephone Station (Fig. 1) is the basic apparatus used by the customer for all types of PICTUREPHONE service. It is associated with a telephone set equipped with a 12-button TOUCH-TONE dial capable of being wired for speakerphone in the on-hook condition, and provides for mounting appropriate circuit packs and cable equalizers, or networks, to provide the requirements for a complete video station.

1.08 A *single line station* is a 2C Video Telephone Station served by an individual line having no association with a 1P2 Key Telephone System (KTS). A *key telephone station* is a 2C Video Telephone Station served by one or more video CO, PBX, or intercom lines associated with a 1P2 KTS.

1.09 The 1P2 KTS has been developed to provide standard key telephone features (line pickup, hold, signaling, intercom, conferencing, etc) in addition to the special features (video switching) required for PICTUREPHONE service. Although more than two video stations may have an audio connection at one time (as in audio conferencing), video switching has been designed to limit the video connection to two stations at any one time with the exception of the 2-or 3-link intercom which may have video connections to two stations per link at one time.

1.10 Within the limitations imposed by video switching, the 1P2 KTS is compatible with

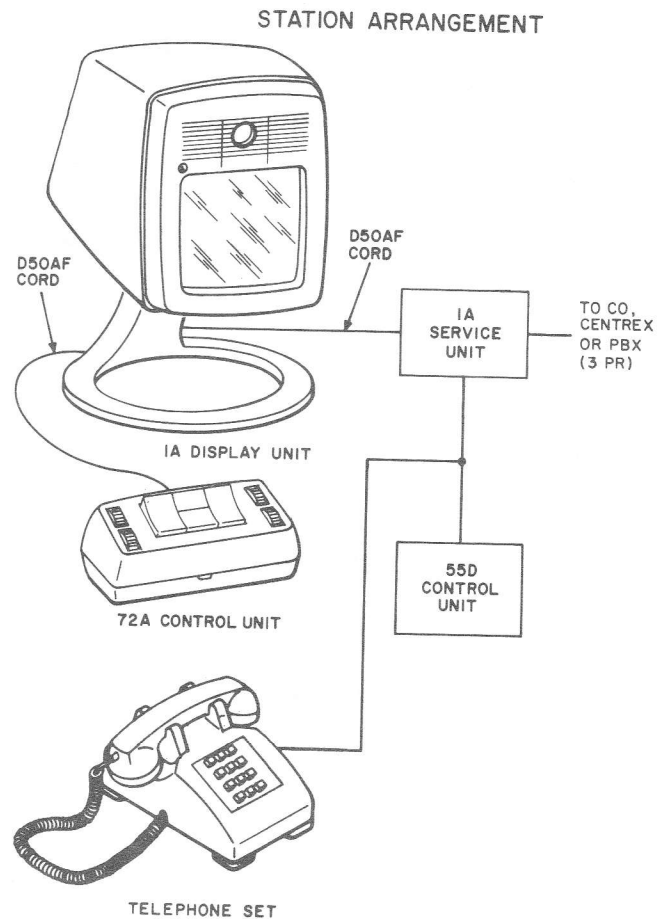

Fig. 1—2C Video Telephone Station

the 1A2 KTS. Many of the same key telephone units are used by both systems, and the lines of both systems may appear at the same key telephone set.

1.11 The lines of 1A1 KTS also appear at the same key telephone set, but signal synchronization and line time-out is different. The 1P2 KTS provides intercom service and may be used with any CO, Centrex, or PBX line that has been modified for PICTUREPHONE service, and with one or more 2C Video Telephone Stations.

2. PRINCIPAL FEATURES

2C VIDEO TELEPHONE STATION

2.01 Components of the station are:

- 1A Display Unit

- 72A Control Unit
- 1A Service Unit
- FW1, FW2, or FW3 Circuit Pack
- 55D Control Unit.

Power and mounting cords, appropriate cable equalizers or networks and a telephone set equipped for 12-button TOUCH-TONE calling and capable of being wired for speakerphone in the on-hook condition must be ordered separately.

2.02 1A Display Unit (Fig. 2): Contains the camera, display tube, and their associated circuitry, speakerphone loudspeaker, and a tone ringer sounder for incoming video call alerting. These units are available in color. A 3-way cord (Fig. 3) in matching color must be ordered separately. The cord connects the display unit to the 72A control unit and to the service unit. Weight of the display unit is approximately 25 lbs.

2.03 72A Control Unit (Fig. 4): Contains the controls for operation of the display unit and the speakerphone. It is available in the same colors as the display unit. Weight is approximately 1/2 lb.

2.04 1A Service Unit (Fig. 5): Mounts on a vertical surface (wall or desk). Contains the power supply for the display unit, additional circuitry not included in the display unit and control units; and provides for interconnecting the cabling from the display unit, the 55D control unit, 72A control unit and the video and audio circuits. A power cord available in various lengths up to 12 feet must be ordered separately. Unit is powered by 117 volts 60 Hz. Weight is approximately 17 lbs.

2.05 55D Control Unit (Fig. 6): Wall mounted. Contains the circuits required for speakerphone operation. Power for the control unit may be provided from the service unit or a 2012B transformer. Weight is approximately 5-1/2 lbs.

2.06 Telephone Sets: The 2500S and 2660-type are typical telephone sets which may be used with the 2C Video Telephone Station. The 2565- and 2662-types are typical 6-button key telephone sets which may be used with the 2C Video Telephone Station when it is used with the



Fig. 2—1A Display Unit

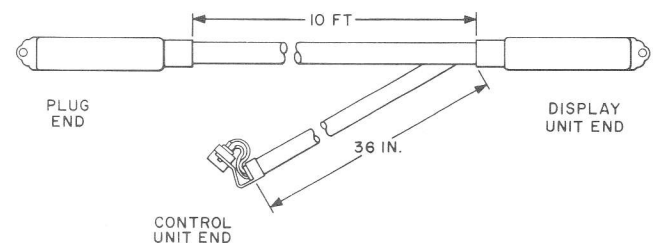
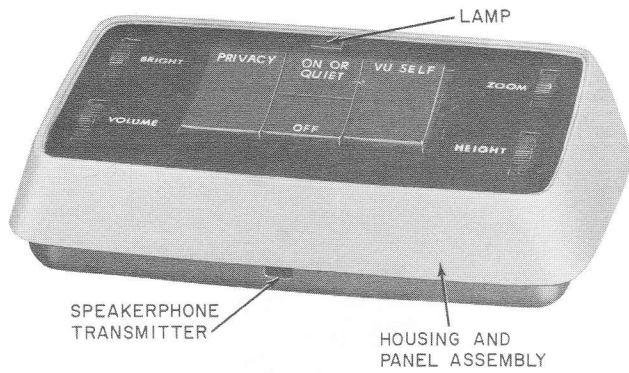

Fig. 3—D50AF Cord

1P2 KTS. Each video line key associated with the 1P2 KTS must be furnished with a KS-20673, L1 lamp (Red-White). Red designates a video call; white, an audio-only call.

SECTION 518-800-100



TPA 542595

Fig. 4—72A Control Unit

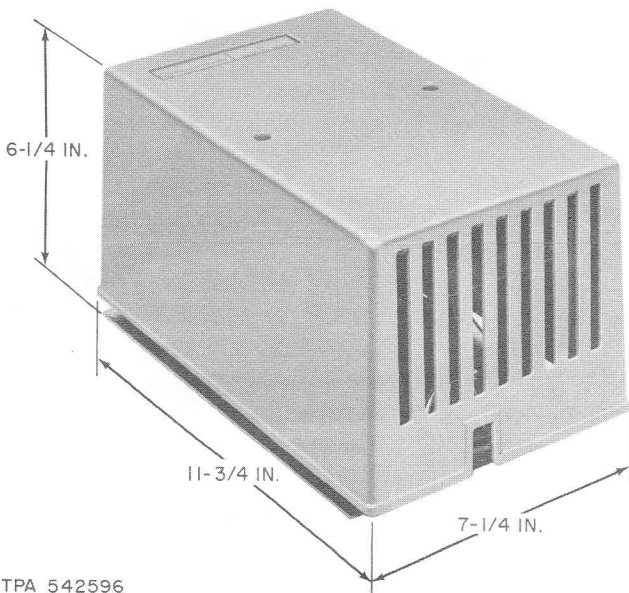

TPA 542596

Fig. 5—1A Service Unit

2.07 When PICTUREPHONE service is furnished from a foreign exchange to a rotary dial location, a TOUCH-TONE adjunct dial, or equivalent, is required. Refer to Section 501-164-130 for additional information.

SINGLE LINE SERVICE

2.08 Single line service is provided by a 2C Video Telephone Station served by PICTUREPHONE line not associated with a 1P2 KTS. Fig. 7 shows a typical installation for a single line station.

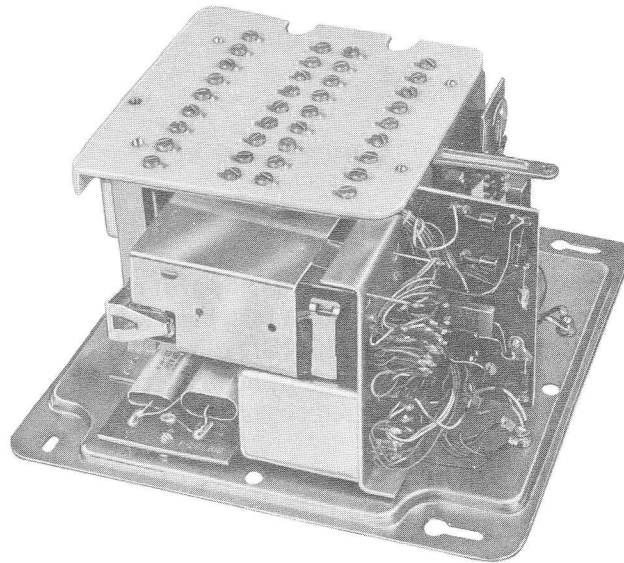

Fig. 6—55D Control Unit (Cover Removed)

1P2 KEY TELEPHONE SYSTEM

A. Type of Station

2.09 Video Station: A PICTUREPHONE station served by one or more video lines. A video station may use a video line to make or receive an audio-only call.

2.10 Audio Station: A telephone station with audio-only access to one or more video lines. An audio station if equipped with a 12-button TOUCH-TONE dial may place or answer a video call for a video station.

B. Type of Service

2.11 Single Group Line Service: One or more video stations having access to a video line. When more than one station is provided, line access must be on a hierarchical (priority) basis. When one of these stations seizes the line on a video call, all lower priority stations are excluded from the video portion of the call, and any higher priority station may preempt the video portion at any time. Audio stations may have audio access to the line. See Fig. 8 for layout of a single group arrangement.

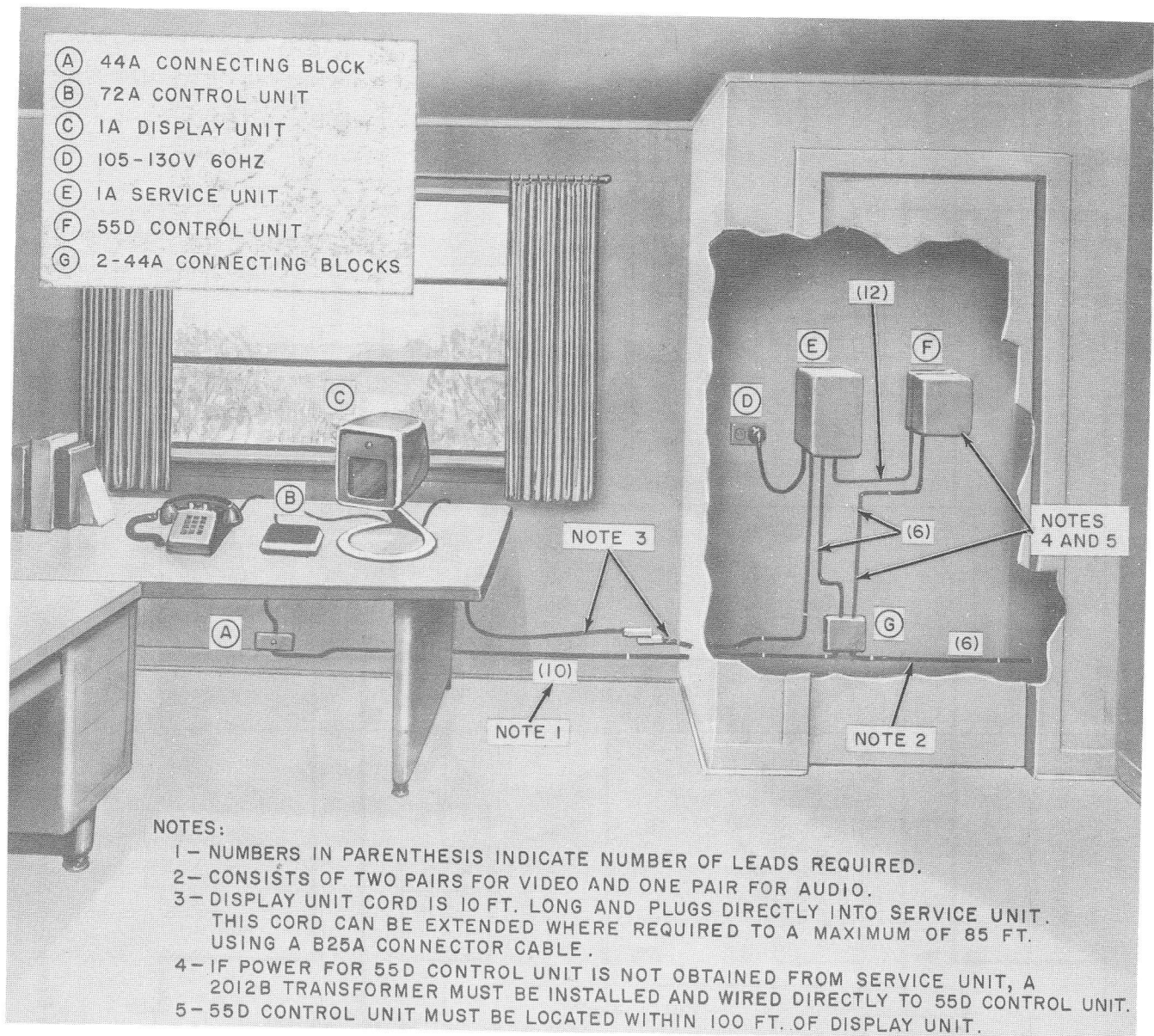

Fig. 7—Typical Installation of a Single Line Station

2.12 Multigroup Line Service: Several groups of video stations having access to a video line (CO, Centrex, or PBX). Up to four groups may consist of one or more stations. Within each such group, video priority must be assigned to the stations as in single group service. Among the groups, however, equal access to the line is provided on a first-come, first-served basis with all other groups then being locked out. Preemption, either on an audio or a video basis, is not possible except within the group that controls the line. See Fig. 9 for a block diagram of a multigroup arrangement.

2.13 Single Link Intercom Service: A video and audio dial selective intercom station arrangement that permits any two station codes to be connected at one time. The service is available in two configurations:

- (a) **0-Line, 10-Station Intercom:** A maximum of 10 single digit (1-0) station codes is provided when a CO, Centrex, or PBX single group line is not used.
- (b) **One-Line, 6-Station Intercom:** A maximum of six single digit (1-6) station codes is

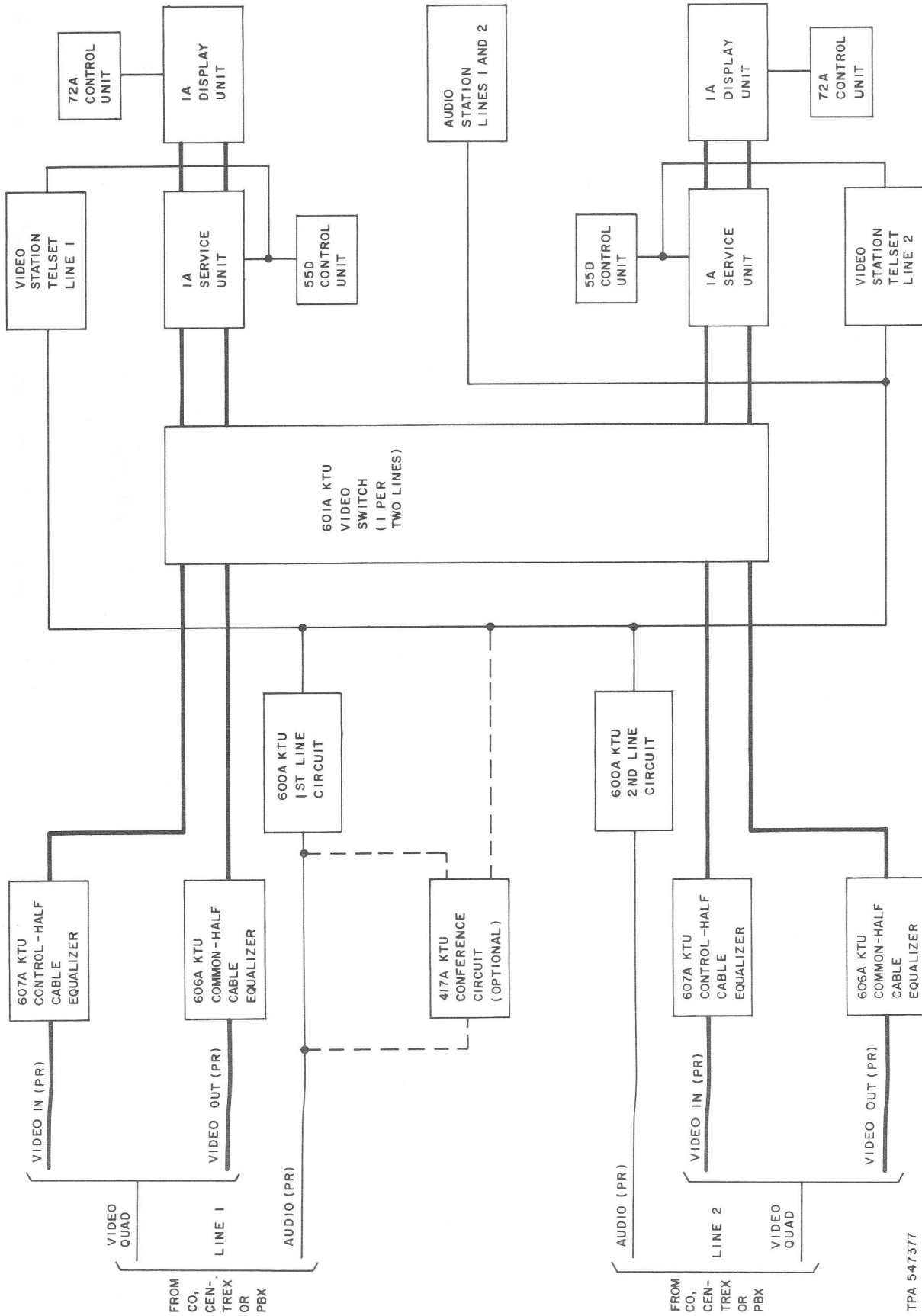
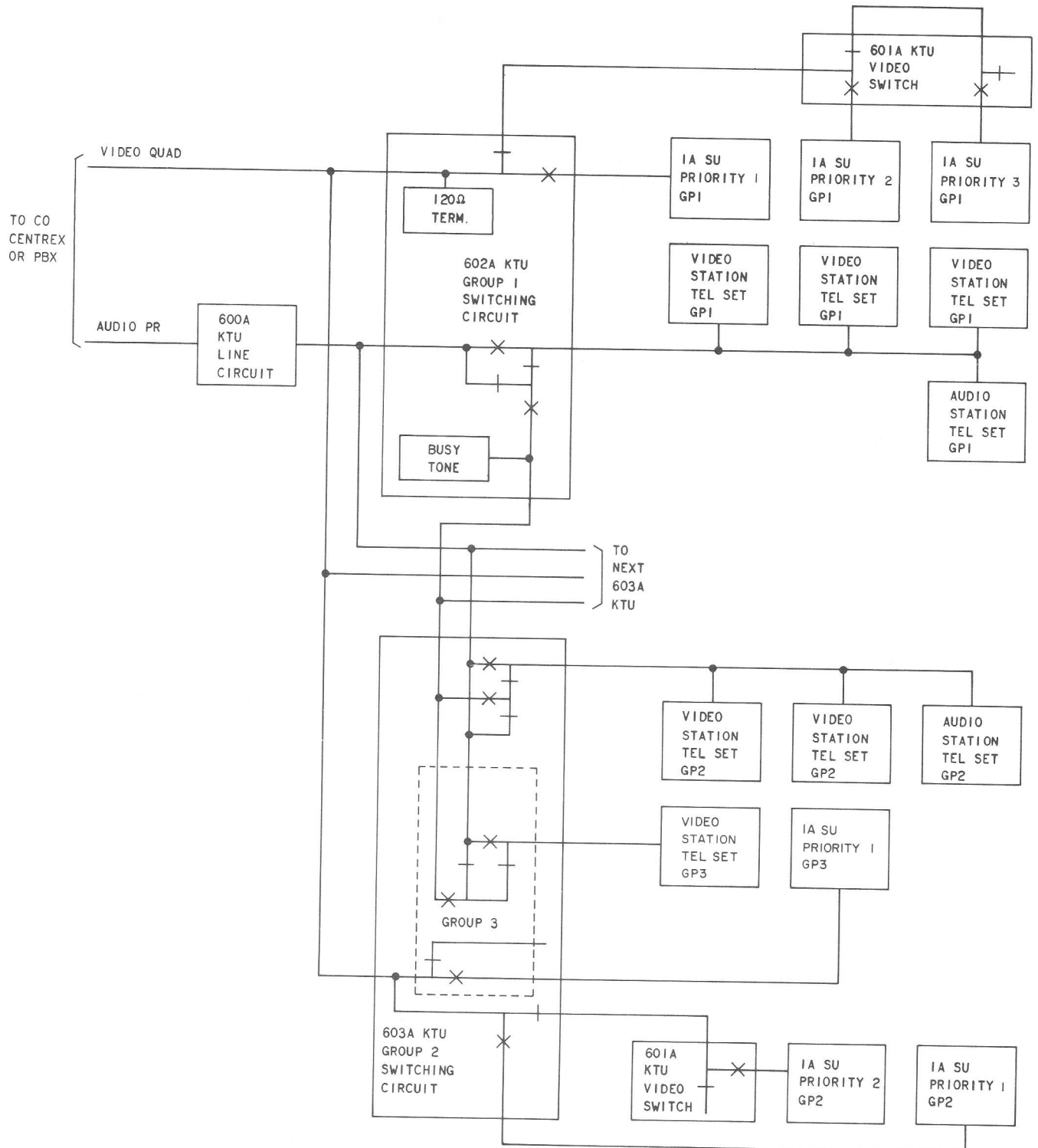

Fig. 8—Single Group Line Service, 2-Line Arrangement with Add-on Conference



TPA 547383

Fig. 9—Multigroup Line Service Arrangement

SECTION 518-800-100

provided when one single group CO, Centrex or PBX line is used. See Fig. 10 for a block diagram of this arrangement.

Audio stations may have access to the intercom by having an assigned station code or by sharing a video station code (video-audio station bridging).

2.14 **2- or 3-Link Intercom Service:** A video and audio dial selective intercom station arrangement that provides an audio and video transmission path between two stations. Both the 2- or 3-link arrangement provide for up to 27 station codes. The 2-link arrangement has two independent talking and viewing paths while the 3-link arrangement has three independent talking and viewing paths. Optional features are:

- Direct station selection (DSS)
- Register recall (RRC) for 3rd and 4th party audio add-on
- Station hold, CO or PBX add-on and video transfer into the system
- Access to a customer-provided paging system
- Voice-switched PICTUREPHONE Intercom Conferencing Key System (PICKS)

PICKS feature permits properly equipped stations to establish a voice-switched PICTUREPHONE conference for up to four stations. A fifth station (such as an attendant) may be added to the conference only on a temporary basis. Only one PICKS connection may be made at one time.

See Fig. 11 for block diagram of the 2- or 3-link intercom arrangement.

C. Ringing Options

2.15 Normally, a station is alerted to an audio-only call as usual and to a video call by tone ringing, but any arrangement is possible. Ringing options of the 1P2 KTS are line ringing and local ringing. Various arrangements that may be provided for local ringing are:

- Interrupted ringing
- Common audible ringing with diode matrix control

- Steady ringing

D. Type of Mountings

2.16 Key telephone units (KTUs) that comprise the basic service arrangements of the 1P2 KTS may be mounted in one of the following:

- 650A1 Key Service Unit (KSU)
- 650A2 Key Service Unit (KSU)
- J53051A Equipment Bay
- J53051B Equipment Bay
- J53051C Equipment Bay

Table A lists the KTUs required to provide the various service arrangements. Certain arrangements and optional features require externally mounted and separately powered KTUs.

650A-Type Key Service Unit

2.17 A wall mounted unit (Fig. 12) with swing out carriers that accepts plug-in type KTUs. It is universally wired to accept the various KTUs that provide for one of the following arrangements:

- (a) One or two single group CO, Centrex, or PBX lines; one video station may pick up both lines, or two video stations may each pick up one of the two lines.
- (b) One single group line picked up by one video station and a 6-station single link intercom.
- (c) A 10-station single link intercom.

2.18 The 650A1 KSU is not equipped with an internally mounted power unit. The 650A2 KSU is equipped with a 51C1 power unit. Both KSUs are furnished with a fuse panel and fuses.

2.19 A KS-15900, List 1 interrupter provides the audible and visual signaling interruption rates for the KSU.

2.20 Two internal 66-type connecting blocks are provided for the cross connection facilities for the various services and options.

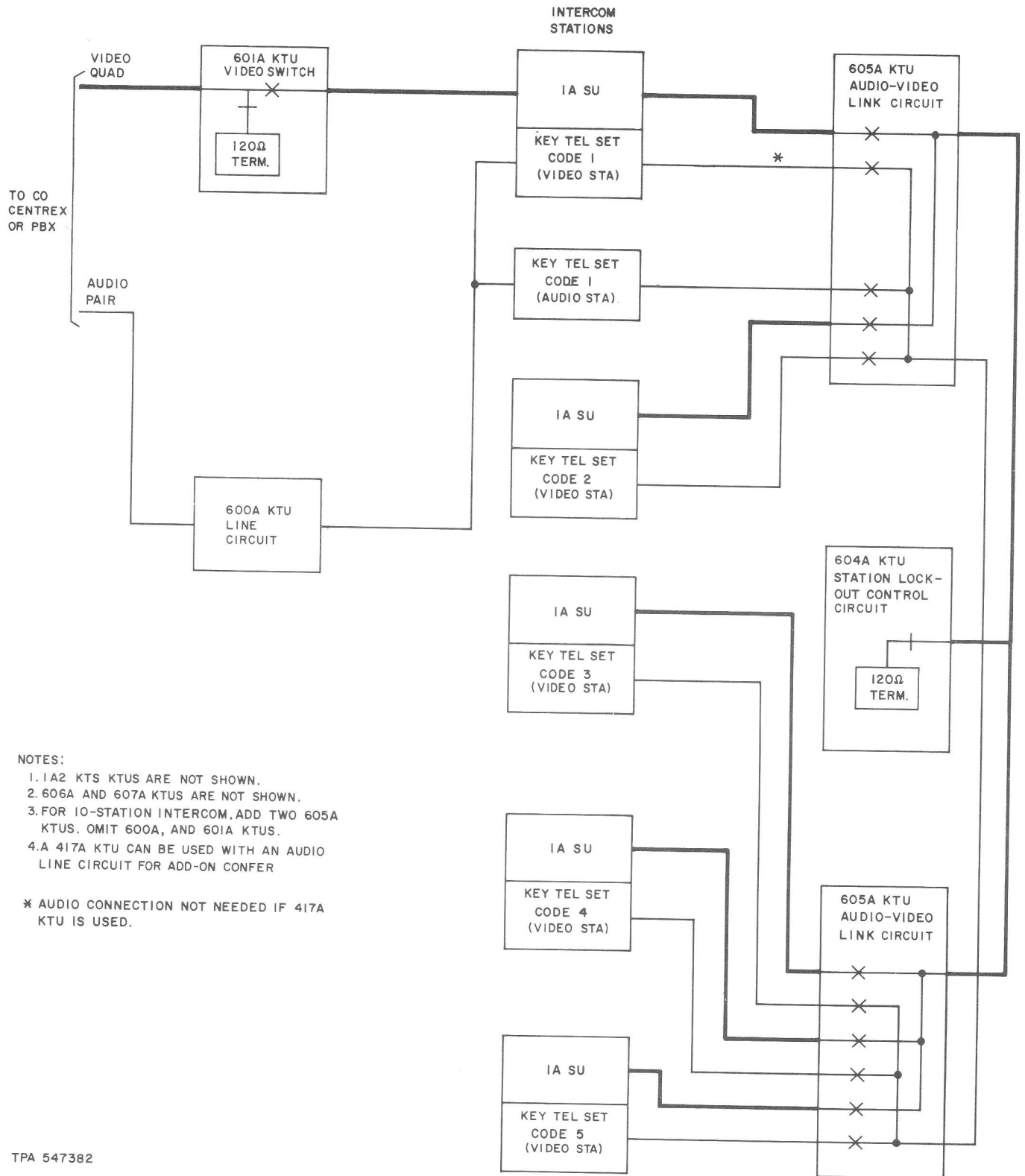
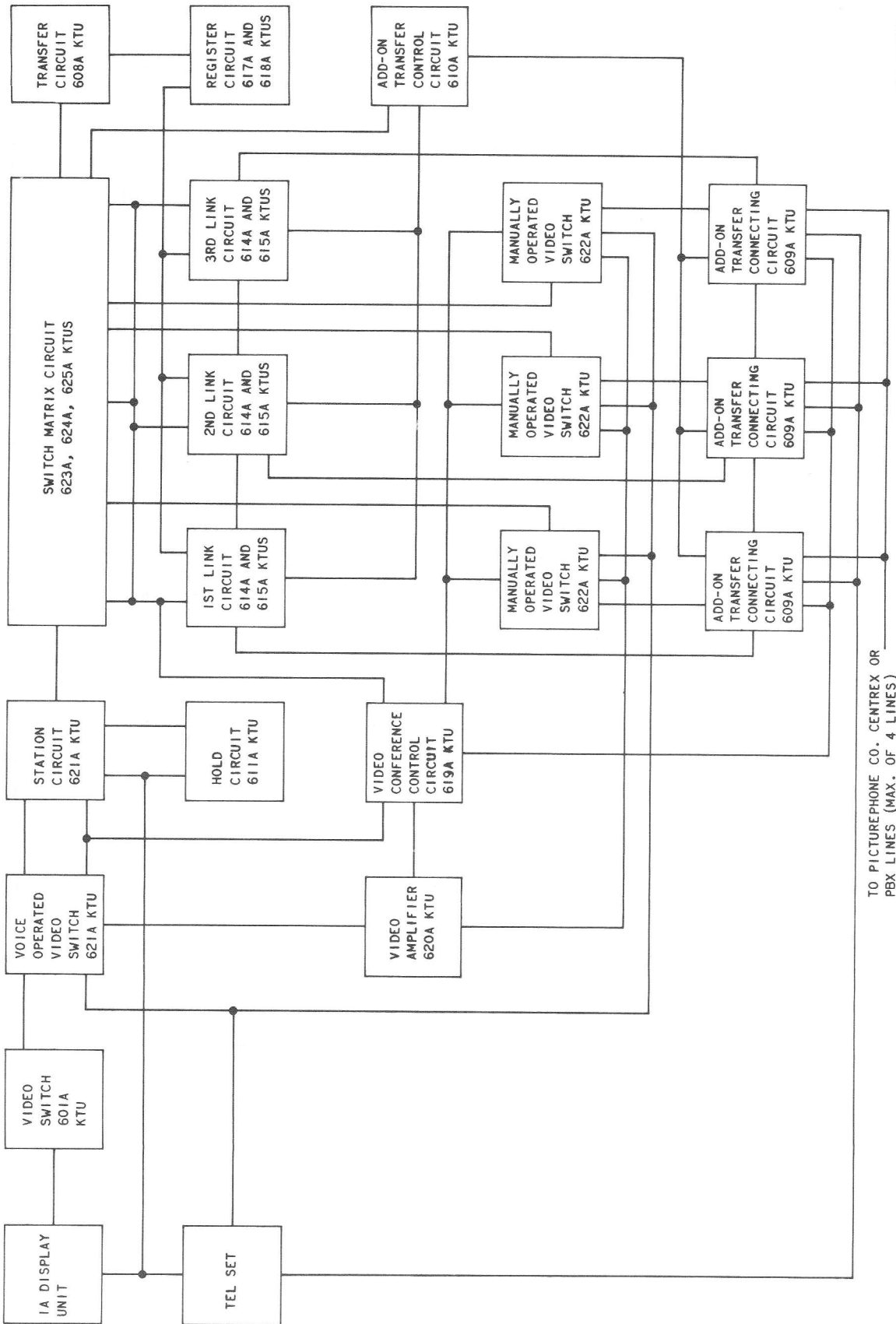

Fig. 10—Single Link Intercom Service One Line, 6-Station Intercom Arrangement



TPA 562551

TO PICTUREPHONE CO. CENTREX OR
PBX LINES (MAX. OF 4 LINES)

◆ Fig. 11—2-or 3-Link Intercom Service Arrangement ◆

TABLE A
KTU'S REQUIRED FOR VARIOUS SERVICE ARRANGEMENTS

| § KTU | LINE SERVICES | | | INTERCOM SERVICE | | | | |
|----------|---------------|---------------------------|---------------------------|-----------------------------------|------------|--------------|--------|------------|
| | SINGLE GROUP | | MULTI- GROUP 1-LINE | SINGLE LINK | | 2- OR 3-LINK | | PICKS † |
| | 1-LINE | 2-LINE ADD-ON CONF. | | 6-STATION WITH ADD-ON CONF. | 10-STATION | 2-LINK | 3-LINK | |
| 407B | | | | | 1 | | | |
| 412A | 1* | 1* | 1* | | | 1* | 1* | |
| 413A | | | | | | 1* | 1* | |
| 417A | | 1 | | 1 | | | | |
| 421A | | | | † | † | | | |
| 422B | | | | 1 | 1 | | | |
| 423A | | | | 1 | 1 | | | |
| 424A | | | | | | 1 | 1 | |
| 425B | | | | 1 | 1 | | | |
| 426A | | | | 1 | 1 | 1 | 1 | |
| 427C | | | | 1 | 1 | 1 | 1 | |
| 600A | 1 | 2 | 1 | | | | | |
| 601A | 1 | 1 | 2 | | | ‡ | ‡ | |
| 602A | | | 1 | | | | | |
| 603A | | | 4 | | | | | |
| 604A | | | | 1 | 1 | | | |
| 605A | | | | 2 | 4 | | | |
| 606A | 1 | 2 | 1 | | | | | |
| 607A | 1 | 2 | 1 | | | | | |
| 608A | | | | | | | | |
| 609A | | | | | | | 1 | |
| 610A | | | | | | ‡ | ‡ | |
| 611A | | | | | | ‡ | ‡ | |
| 612A | | | | | | ‡ | ‡ | |
| 614A | | | | | | ‡ | ‡ | |
| 615A | | | | | | 2 | 3 | |
| 616A | | | | | | 2 | 3 | |
| 617A | | | | | | ‡ | ‡ | |
| 618A | | | | | | 1 | 1 | |
| 619A | | | | | | 1 | 1 | |
| 620A | | | | | | | | 1 |
| 621A | | | | | | | | 2 |
| 622A | | | | | | | | ‡ |
| 623A | | | | | | | | ‡ |
| 624A | | | | | | 8** | 12** | |
| 625A | | | | | | 8** | 12** | |

* Required in each carrier in J53051B bay and once in J53051C bay for signal synchronization with another system.
 † Quantity as required. May be used as a video switch to prevent loss of station code in audio-video station bridging arrangement.

‡ Quantity as required to provide desired service.

§ Refer to Sections 518-215-400 and 518-800-105 for identification of 400- and 600- series KTU's, respectively.

¶ Provide these KTU's in addition to those required for 2- or 3-link intercom.

** For a full complement of 27 stations.

For a maximum of 21 stations these numbers would be 6 and 9. For 14 stations 4 and 6 and for 7 stations 2 and 3.

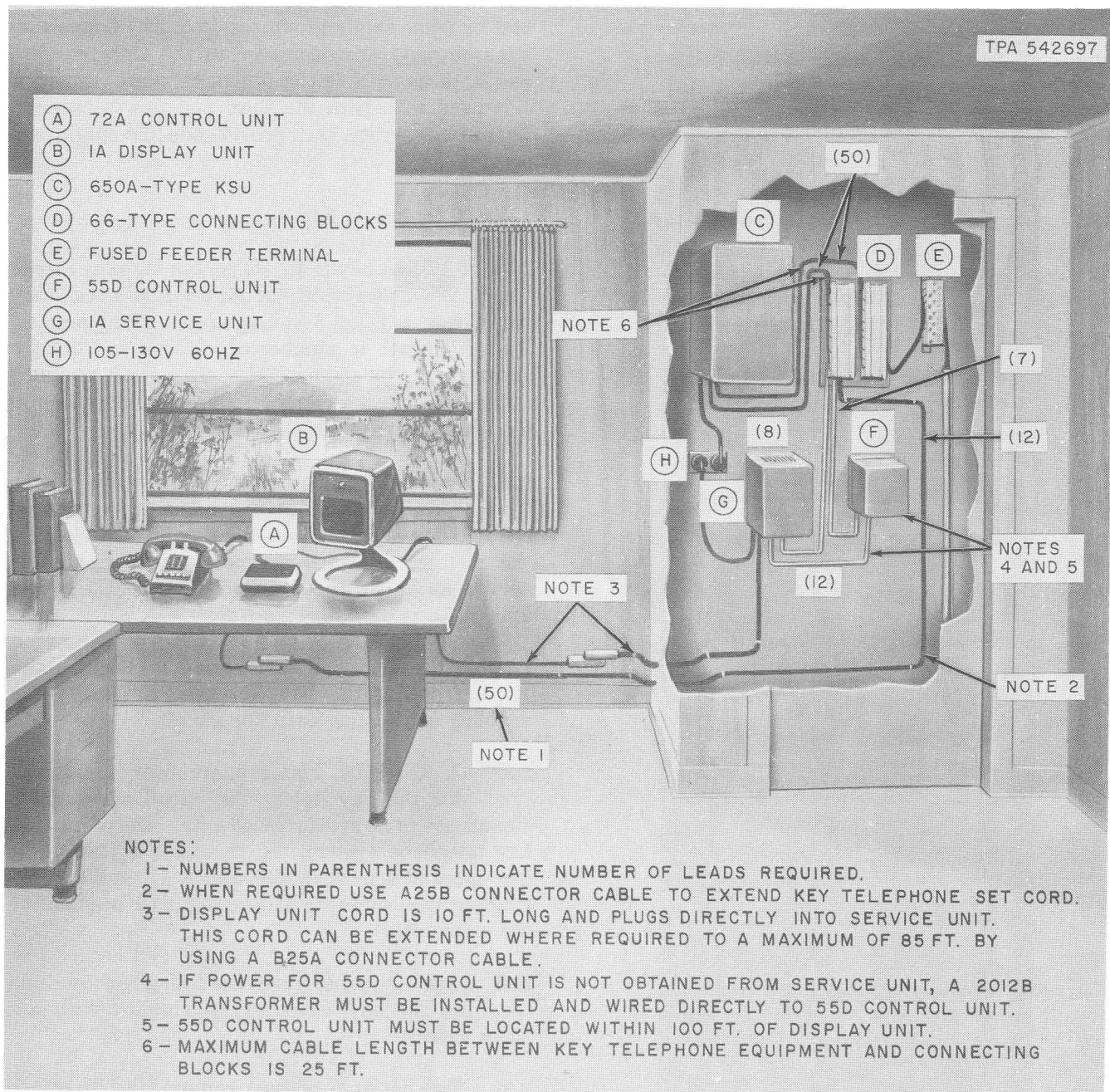

◆ Fig. 13—Typical Installation Layout, 1P2 Key Telephone System Using 650A Key Service Unit ◆

2.29 Each carrier is powered by a 51C1 power unit in the same manner as the J53051A Equipment Bay.

2.30 One KS-15900, List 1 interrupter is required for the bay and one 412A KTU is required for each carrier.

2.31 Each carrier is provided with its own fusing.

2.32 Three internal 66-type connecting blocks are provided for the cross-connection facilities for services and options.

2.33 Connectors A through D are dedicated to the first (upper) two carriers which provide

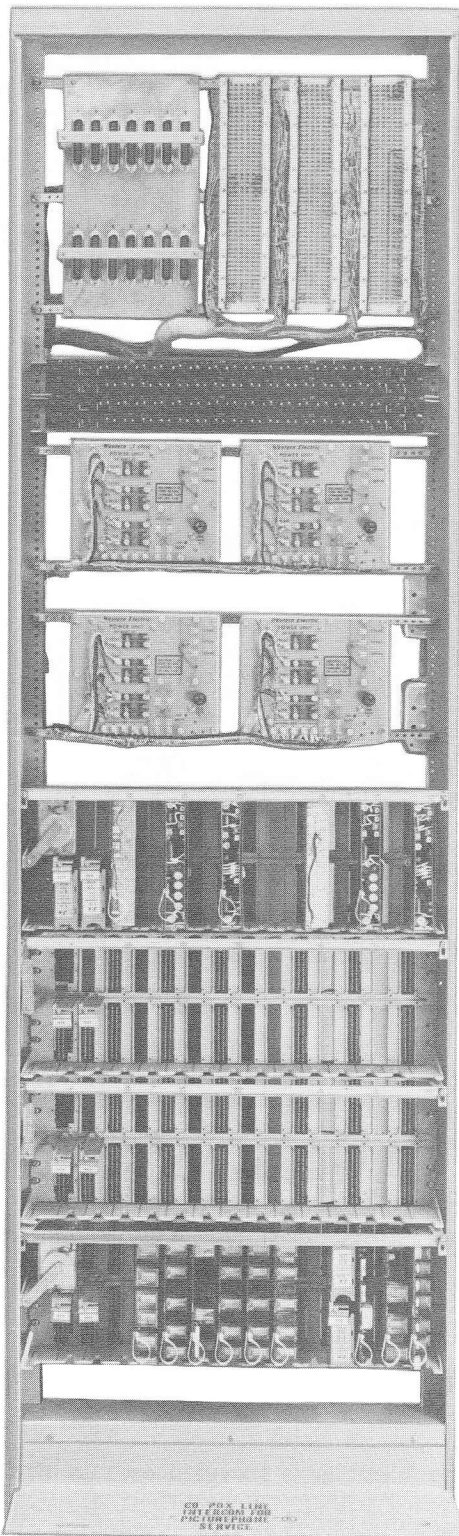

TPA 550468

Fig. 14—J53051A Equipment Bay

one- or 2-line single group service only. Connectors E through H are dedicated to the third carrier, and K through N to the fourth carrier. Connector J is used with both the third and fourth carriers. These two carriers each provide one-line multigroup service.

J53051C Equipment Bay

2.34 A 7-foot bay (Fig. 16) containing nine carrier assemblies which mount the KTUs necessary to provide a 2- or 3-link intercom arrangement. System growth in number of stations and links is accomplished by adding KTUs. Externally mounted apparatus may be required for certain options in the arrangement.

2.35 One 63C1 power unit supplies the power requirements for the bay. An electrical conduit box is located on the bay for terminating the customer-provided commercial power and also serves as an ac receptacle for the 63C1 power unit.

2.36 An alarm and test panel, located on the front of the bay, provides a facility for enabling and testing each link circuit.

2.37 A KS-15900, List 1 interrupter is required for the bay unless the visual and audible signals are to be synchronized with those of another key telephone system. In this case a 412A KTU (for lamp synchronization) and a 413A KTU (for ringing synchronization) are required in place of the interrupter.

2.38 One fuse panel serves the fusing requirements of the bay. The bay is shipped with the fuses installed.

2.39 Two internal 66-type connecting blocks are provided for the cross connections necessary for the various services and options.

External Mountings for KTUs

2.40 In many cases externally mounted KTUs must be powered by an additional externally mounted power unit; type and mounting must be determined locally according to the KTUs to be powered. The external KTUs may be mounted in 69-type apparatus mountings, on 99-type brackets or mounting bars in 16-type apparatus mountings, or on standard relay racks or carriers.

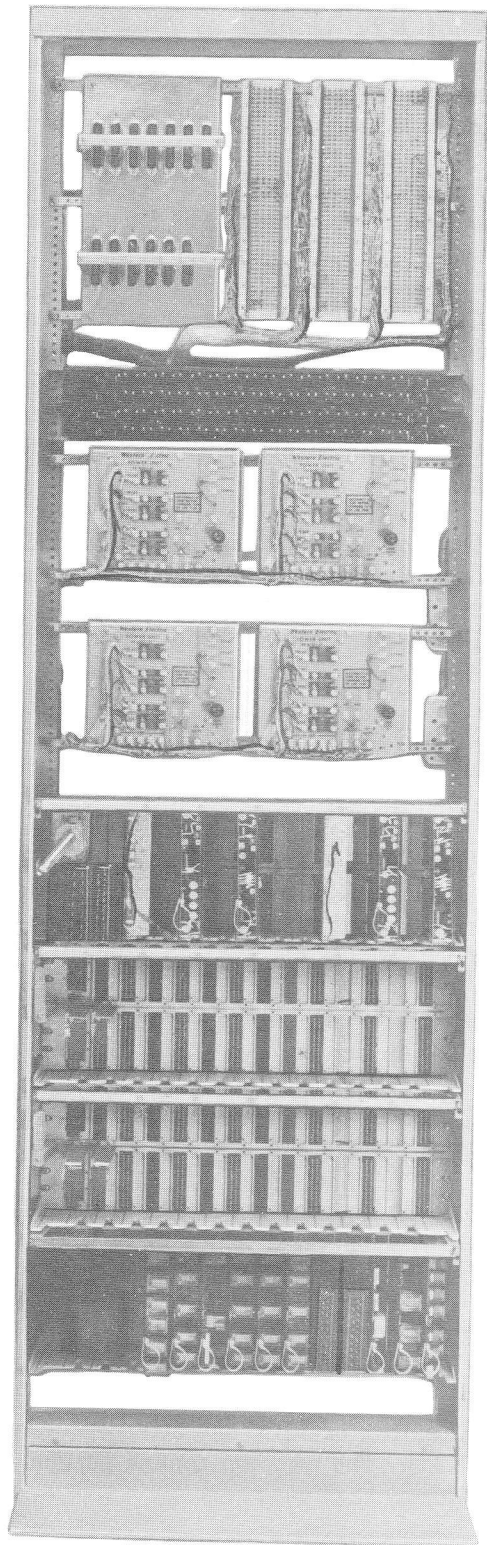

TPA 550469

Fig. 15—J53051B Equipment Bay

2.41 Facilities have been provided in the 650A2 KSU and J53051A and J53051B bays to permit the use of the internal power to supply external KTUs where the capacity of the internal supply will not be exceeded.

2.42 The power unit for the J53051C bay will supply power for a fully equipped bay only. Any externally mounted KTUs must be powered by another power unit.

E. Key Telephone Units

2.43 The key telephone units for PICTUREPHONE service consist of plug-in type 600 series KTUs, which operate in conjunction with 400 series KTUs to provide intercom and line services. See Table A for the KTUs required for a particular type service. Refer to Section 518-215-400 for information on the 400 series KTUs.

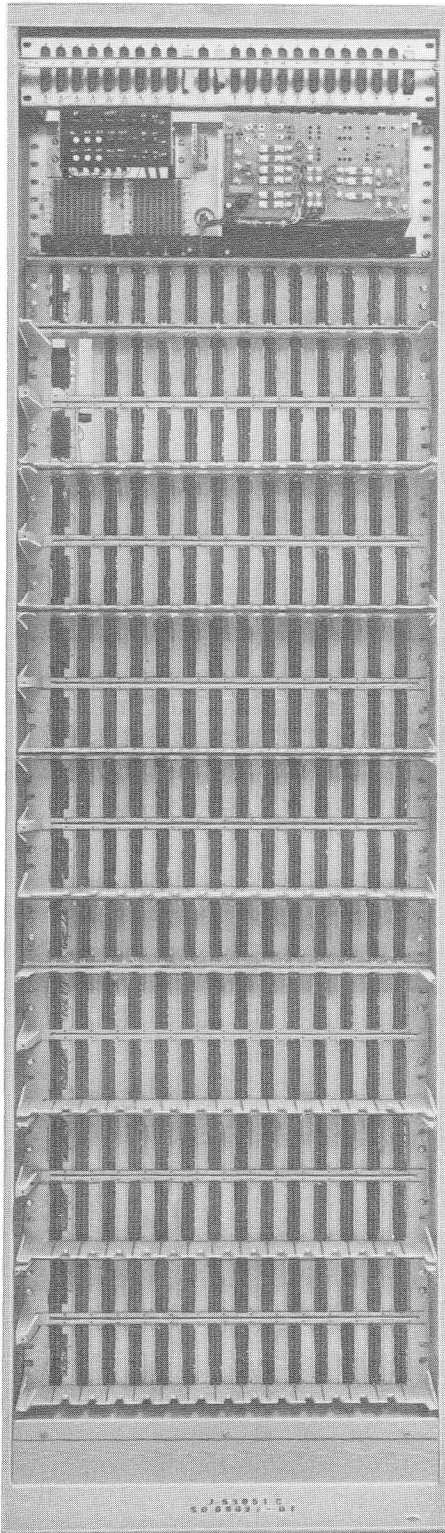

TPA 550470

Fig. 16—J53051C Equipment Bay

2.44 600A KTU (Single or Multigroup Line Circuit): Provides certain functions and features needed for PICTUREPHONE service. These features are:

- Pickup and hold of a CO, Centrex, or PBX line on an audio only basis for an audio/video call
- Choice of line ringing or common audible ringing
- Distinctive flashing lamp and audible signal to distinguish an audio or video incoming call
- Distinctive steady lamp signal to indicate a busy condition on an audio or video call
- Distinctive winking lamp signal to indicate when an audio or video call is held
- Individual line time-out of audible and visual signals on an abandoned incoming call.

2.45 601A KTU (Video Switch for Line or Intercom Service): Consists of two independent 4-wire video switch circuits on one printed wiring board which provide:

- Switching of two video lines to a single video station or
- Switching of two video stations to a single video line and
- An idle line termination for each video pair in the unoperated condition.

2.46 602A KTU (Common Control and Group 1 Switching Circuit for Multigroup CO, Centrex, or PBX Line): Connects Group 1 to the CO, Centrex or PBX line attendant group via a 600A KTU. The common control portion of this unit provides:

- Common control for lockout
- System busy tone
- Termination of video line during idle and hold conditions.

- Priority on simultaneous seizure of the line by different groups.
- Time-out over line switch flash
- Directed call transfer with an external relay.

2.47 603A KTU (Group Switching Circuit for Multigroup CO, Centrex, or PBX Line):

Connects any two groups other than Group 1 via a 600A KTU to the CO, Centrex, or PBX line or to system busy tone when they are locked out. Switching functions are the same as for Group 1 in the 602A KTU.

2.48 604A KTU (Station Lockout Circuit for Single Link Intercom): Provides the following functions:

- Recognizes a PICTUREPHONE call and directs distinctive audible and visual signaling
- Provides idle line termination of video pairs
- Enables selected calling station circuit
- Privacy for connected stations
- Connects a system busy tone to audio/video switches of locked out stations
- Provides a distinctive steady lamp voltage for all stations to indicate a system busy condition (audio or video).

2.49 605A KTU (Audio/Video Link Circuit for Single Link Intercom): Connects the audio and video pairs of the calling and called stations. This unit also provides:

- System busy tone to locked out stations
- Video pair reversal
- Turn-on-set control function
- Circuits to connect three stations

2.50 606A KTU (Common-Half Cable Equalizer): For video pair equalization from the customer to the CO or PBX. It provides:

- An input network which converts the incoming balanced signal to the unbalanced mode for equalization

- A simple static equalizer which is basically a shaped gain amplifier used to compensate for loss in the transmission line. It is not adjustable.

- A sync detector for recognizing the CO originated video supervisory signal which identifies a video call

- A remove loop-back function

- An output network for restoring the static equalizer output to the balanced mode for further transmission.

2.51 607A KTU (Control-Half Cable Equalizer): For video pair equalization from the CO or PBX to the customer: It provides:

- An input and output network similar to the 606A KTU (common-half cable equalizer)
- A static equalizer which is basically a shaped gain amplifier which compensates for loss in the transmission line. Screw adjustments are provided for short, intermediate, or long length cables.

2.52 608A KTU (Transfer Circuit for 2- or 3-Link Intercom): Expands the output leads of the 424A KTU (19-code selector circuit) to a total of 27 output leads (codes).

2.53 609A KTU (Add-on Transfer Connecting Circuit for 2- or 3-Link Intercom) Provides for:

- Removing hold condition of CO or PBX line associated with the intercom
- Connecting the CO or PBX audio/video line to the intercom link being used.
- Connecting lamp voltage to the lamps of all add-on keys associated with the same line
- Holding both intercom stations during the added-on condition and prior to video transfer so that either one may leave the intercom call and return as long as the other station does not hang up.

2.54 610A KTU (Add-on Transfer Control Circuit for 2- or 3-Link Intercom): Consists of three independent circuits mounted on one printed

SECTION 518-800-100

wiring board. Each circuit serves to activate the add-on transfer connecting circuits associated with the same link.

2.55 611A KTU (Hold Circuit for 2- or 3-Link Intercom): Consists of two independent circuits mounted on one printed wiring board. One hold circuit is required for each station equipped with the hold feature. The hold circuit:

- Maintains the associated station circuit operated during the hold condition.
- Causes the associated video crosspoint relay to release, removing video from the held station.
- Controls lamp wink mode of the held intercom station.

2.56 612A KTU (Station Circuit for 2- or 3-Link Intercom): One station circuit is required for each intercom station. It provides the following features:

- Serves as an interface between the video station and the key telephone (intercom) system.
- Signals the register circuit when service is requested
- Differentiates between called and calling party
- Distinguishes between an audio or video incoming call by distinctive flashing lamp and audible signal.
- Provides a choice of audible signaling options.

2.57 614A and 615A KTUs (Link Circuit for 2- or 3-Link Intercom): In conjunction with the register, controls an associated portion of the switch matrix. The link circuit also provides for:

- Station dialing and control functions associated with optional features.
- Talk battery to connected stations
- Audible tones (dial, ringback, station busy and permanent signal timeout)

- Control of CO or PBX lines added to intercom by stations equipped with add-on feature.
- Preventing video connection between more than two stations when a third or fourth station is brought in using the add-on feature.
- Stations to be alerted by use of a DSS (direct station selection) key.
- Recalling of register circuit by means of a register recall key (located at station).

2.58 616A KTU (Paging Control Circuit for 2- or 3-Link Intercom): Permits dial access to a customer-provided paging system via a standard paging trunk circuit. The paging circuit is substituted for a station circuit (612A KTU) in this arrangement. The use of a paging circuit causes the loss of a station code.

2.59 617A and 618A KTUs (Register Circuit for 2- or 3-Link Intercom): Provides the main control functions during the processing of an intercom call. The register circuit:

- Recognizes requests for service and activates the selector (424A KTU)
- Selects and enables an idle link circuit.
- Releases selector and connects it to the selected link circuit
- Causes dial tone to be transmitted to the calling party from the selected link circuit and removes dial tone when the first dial pulse is received by the selector.
- Signals link circuit to connect appropriate audible tones.

2.60 619A KTU (Video Conference Control Circuit, PICKS, for 2- or 3-Link Intercom): Provides the circuitry necessary to establish a PICKS conference connection. It contains a common circuit and three identical control circuits (one for each link). The common circuit provides the memory for leader override and voice-switching. Each control circuit:

- Establishes a PICKS conference on its associated link and excludes PICKS conferencing on the other link(s).

- Applies power to those voice-operated video switches (621A KTU) connected to the PICKS conference.
- Lights CONF key lamps
- Prevents unnecessary seizure of PICKS circuitry
- Connects common video quad leads of the switch matrix to the video amplifiers (620A KTU)
- Disconnects itself if only one party remains on hook.

2.61 620A KTU (Video Amplifier, PICKS, for 2- or 3-Link Intercom): Allows five PICTUREPHONE stations to be bridged with no attenuation of signal strength.

2.62 621A KTU (Voice Operated Video Switch, PICKS, for 2- or 3-Link Intercom): Consists of two identical circuits mounted on one printed wiring board. Each circuit:

- Switches the video pairs to and from the appropriate video amplifiers during a PICKS conference.
- Responds when the speakerphone associated with a PICTUREPHONE station has been switched to the transmit state by an audio signal.
- Operates in five different states: Present Talker, Last Talker, Listener, Leader Override, and Held.

2.63 622A KTU (Manually Operated Video Switch, PICKS, for 2- or 3-Link Intercom): Manually connects a CO or PBX line into a PICKS conference. It allows a CO or PBX station to participate in a video conference but not in the same manner as a voice switched station. It is manually controlled by any intercom station equipped with a line key associated with CO or PBX line. When this occurs, all voice switching is inhibited, and remains in this state until the PBX or CO line key is released.

2.64 623A, 624A and 625A KTUs (Switch Matrix Circuit for 2- or 3-Link Intercom): Each KTU contains seven relays which provide all of

the crosspoint contacts required to interconnect stations with the intercom. The three relays associated with each link circuit provide the switching functions necessary for the audio, video, and features portion of a call. Each KTU provides crosspoint connections for seven stations per link in the intercom; therefore a 3-link intercom (28 stations) requires 12 of each type KTU. ♦

F. Video-Audio Station Bridging

2.65 Allows a bridged audio station to answer or place a call on an audio-only basis. If equipped with a TOUCH-TONE dial it may also place a video call for its associated video station. This arrangement applies to both line and intercom arrangements.

G. Add-on Conference

2.66 Permits a single link intercom line, another single or multigroup line, or some other CO or PBX line to be added on to a single group line to provide a 3-way audio and 2-way video connection under control of one video station having access to both arrangements.

H. Add-on Transfer

2.67 A station (if key equipped) having access to a 2- or 3-link intercom and a single or multigroup CO or PBX line has add-on conference capability between the CO or PBX line and another intercom station as described in 2.66. Also when the controlling intercom station hangs up, video from the the CO or PBX line will be transferred to the remaining intercom station.

I. PICTUREPHONE Intercom Conference Key System (PICKS)

2.68 A properly equipped video station can participate in a voice-switched PICTUREPHONE conference with up to four other similarly equipped video stations. Stations not equipped for PICKS may participate in a PICKS conference on an audio only basis. A PICKS conference may be established on any link of the intercom, but only one conference can be held at one time. Distinctive lamp signals alert PICKS equipped stations that a conference call is in progress. Other PICKS features are:

- Present speaker views last speaker and listeners view present speaker

- Leader override of voice-switching
- One CO or PBX line can be added to the conference
- Computer access via a CO or PBX line

3. OPERATING FEATURES

2C VIDEO TELEPHONE STATION

3.01 Audio-only calls can be made with any type of 1P2 KTS service using a rotary or TOUCH-TONE dial. When video calls are made, the station number or code is prefixed by dialing the #button on the 12-button TOUCH-TONE dial.

3.02 Audio operation of the station is similar to any station equipped with a speakerphone. Additional controls or adjustments necessary for PICTUREPHONE service are located on the 72A control unit (Fig. 4).

3.03 On the 72A control unit the left-side adjustments (knurled finger wheels) BRIGHT and VOLUME are associated with the incoming picture and sound. The right-side adjustments ZOOM and HEIGHT are associated with the size and vertical movement of the transmitted picture which can be monitored by the VU SELF button. Operation of the PRIVACY button transmits a horizontal bar image. To return to normal operation both the VU SELF and PRIVACY buttons must be restored manually. Operation of the ON OR QUIET button turns the speakerphone on, and disables the speakerphone transmitter as long as the button is depressed. The OFF button turns off the station and mechanically restores PRIVACY and VU SELF buttons to the off position if they were not previously restored manually.

3.04 A GRAPHIC VISOR on the display unit, when pulled out, positions a mirror in front of the camera and permits information of a graphic nature, placed on the table at the base of the display unit, to be transmitted to the distant end.

3.05 Incoming video calls will normally be distinguished from audio calls by a tone ringer sounder located in the display unit. Pick-up buttons on the key telephone set associated with a video line (including intercom) are equipped with a special lamp indicating red for video and white for audio calls.

3.06 The camera will adjust automatically for varying lighting conditions; therefore, a light source behind the user or reflected from his glasses may cause the camera to lose facial details. Customer satisfaction will depend upon understanding of this feature.

1P2 KEY TELEPHONE SYSTEM

3.07 The audio portion of the system operates essentially the same as in the 1A2 KTS. Therefore, audio will be discussed only to distinguish it from video.

A. Single Group Line Service

3.08 *Receiving a Video Call:* The CO or PBX applies a video supervisory signal (VSS) to the incoming video pair. The common-half cable equalizer detects VSS and signals the line circuit to go into the video mode. When ringing is detected by the line circuit, distinctive ringing and a flashing red lamp signal are applied to the service unit and telephone set, respectively. When the video station goes off-hook, ringing is retired, the red lamp lights steady, the 2-way video path is completed, and a Turn On Set (TOS) signal is sent to the service unit.

3.09 *Originating a Video Call:* The line circuit operates on line seizure, causing a white lamp indication in the telephone set. On calls prefixed by dialing the # button, the CO or PBX recognizes that a video call has been dialed, and a burst of VSS is sent back to the common-half cable equalizer which causes the line circuit to go into the video mode, which in turn changes the associated telephone lamp to a steady red.

3.10 *Loopback:* When the system is in the idle state, a loopback path is provided between the transmit and receive pairs of the video quad for transmission testing. This loopback path is established by the common-half cable equalizer under control of the line circuit.

3.11 *Priority Stations, Line Terminations:* When video switches are used to provide multistation access on a priority basis, video idle line termination is provided only at the lowest priority switch and is arranged so that it is removed by the operation of any of the switches in the chain. A video station going off-hook, operates its associated video switch. Operation of a given

switch causes lock-out of all lower priority switches. A station of higher priority may preempt the video transmission of a station already using the video line simply by going off-hook. A station may relinquish video transmission to a lower priority station, by simply going on-hook.

3.12 Conferencing Circuit: When connecting the audio portion of two video lines together by using an add-on conference or add-on transfer circuit, the controlling telephone set must have a hold circuit, a nonlocking conference key, and access to two video lines associated with the conference circuit. To initiate a conference, the controlling party establishes a connection on a line associated with the bridging circuit, places this line on HOLD, and establishes a connection on the second associated line. When both parties are available, the conference key is operated and both lines are connected together. The conference can be disconnected by going on-hook or turning off the speakerphone. If the conference circuit is released by use of the conference key, the controlling party can elect which line is to remain connected to the controlling station by depressing the key associated with that line before the conference circuit is released. When both lines associated with the conference are video lines, the controlling party may also select which of the two conferenced parties he wishes to see by depressing the key associated with that party. The display unit of the selected party will receive the transmitted information from the controlling video station, while the display unit of the other party will be blank. The controlling party may depress either key at any time while the conference is established, and may go on HOLD if desired, without losing either party.

3.13 Audio Stations: An audio station has access to the audio portion of a video line and may place or answer calls in the same manner as a video station.

B. Single Link Intercom Service

3.14 Line Seizure and Station Lockout (Fig. 10): When a station picks up the line, it immediately prevents any other station from seizing the line (station lockout). Intercom line lamps in the key telephone stations will indicate white and the calling station will receive dial tone.

3.15 Dial Selection (Audio): Dialing for an audio call can be accomplished with a rotary

or TOUCH-TONE dial. A dial selector circuit recognizes the code of the called station, dial tone is retired, and a tone generator supplies audible ringback to the calling station, while ringing is directed to the called station. The line lamp of the called station flashes white.

3.16 Call Answering (Audio): When the called station answers, its white lamp lights steady and the tone generator is set to the busy tone mode and coupled to all locked out stations.

3.17 Dial Selection (Video): A station is selected for a video call by first dialing the # button. The intercom line lamps switch from steady white to red. When the station code is dialed, the called station line lamp will flash red. The display unit at the calling station is turned on. When the desired station code is dialed, the circuit operates as described in 3.15 except that (a) TOUCH-TONE calling must be used. (b) dial tone is retired by dialing the # number. (c) the display unit of the calling station is turned on. (d) tone ringing occurs at the called station and (e) the line lamp at the called station flashes red.

3.18 Call Answering (Video): When the called station picks up the intercom line, the tone generator is set to the busy tone mode with its output coupled as before, and the video quads of both stations are switched from a common termination to-each other. Because the video output pair of one station becomes the input pair of the other station, the video switch associated with the called station performs a reversal function. All stations now receive a steady red light.

3.19 Video-Audio Station Bridging (Optional):

An audio station may have access to the link to place a call for a video station. The call may be a video call if the audio station is equipped with a 12-button TOUCH-TONE dial. When an audio station originates a call, the station lock-out circuit operates as before. The audio station will have an audio-only connection when the called station answers. Either a video or an audio station may answer a video call. The display units of the video stations are turned on as each picks up the line, and the display units are connected to each other after the last station picks up.

3.20 Signal Key Preset Audio-Only Conference, (Optional): This arrangement can be provided when it is desired to signal and connect

a preselected group of stations for conferencing purposes. A controlling station must be equipped with a signal button. The conference circuit returns to the idle state when the last station hangs up.

3.21 *Dial Selected Preset Audio-Only Conference*

(Optional): This arrangement provides the same service as in 3.20 except that a preselected dial code is used in place of a signal key.

3.22 *Add-On Conference (Optional):*

This arrangement provides add-on conferencing between an intercom connection and a CO or PBX line. Two-way video between a controlling video station and one of the other conferees (depending upon which line key of the control station is depressed) and 3-way audio transmission is made possible by this connection. The conference can be established in two ways. The control station can connect a CO or PBX line to an existing intercom connection by transferring to the CO or PBX line key with the other intercom station remaining off-hook, establishing a CO or PBX line connection, and then operating the nonlocking add-on conference line key; or the control station can connect an intercom station to an existing CO or PBX line connection by placing the existing connection on hold, establishing an intercom connection and then operating the nonlocking add-on conference line key. The video connection can be changed any number of times. The idle video station will have a blank screen. When the conference call is completed, the control station may continue audio-video communication with either of the parties by first operating the line key associated with the desired station and then operating the nonlocking add-on conference key. If the controlling station goes on HOLD and picks up on another line, the remaining two conferees still have an audio connection to each other. If the controlling station goes on-hook, the add-on conference circuit releases and breaks this connection.

3.23 *Busy Video Station Audible Cutoff (BVSAC) for One Station (Optional):*

BVSAC for one video station can be provided so that the called intercom station cannot be rung by another intercom party while it is busy on another line. This arrangement is provided only when an audio station shares its code, so that the audio station can answer the call.

3.24 *Busy Video Station Audible Cutoff (BVSAC) for More Than One Station*

(Optional): BVSAC for more than one video station can be provided as in 3.23 except that additional KTUs must be used for the purpose of recognizing the codes of the called stations to cut off the audible signaling.

3.25 *Station Busy Tone, Optional:* If the circuit is not connected for BVSAC, station busy tone can be provided using a station busy selector mounted externally.

3.26 *Disconnection:* A time delay prevents access to the system by another station before the system reaches its idle condition.

C. *Multigroup Line Service*

3.27 *Line Seizure:* Any video station in group 1 (Fig. 9) going off-hook with the system idle enables an associated video switch and seizes the line circuit.

3.28 The common control circuit excludes (locks out) other groups from access to the system and starts the interrupter.

3.29 The interrupter in turn starts the busy tone generator whose output is applied to tip and ring of all groups except group 1. At this time, the common control circuit also causes the lamps to light steady white at all stations where the line appears.

3.30 An audio station in group 1 going off-hook with the system idle will operate the system as previously described except that no video switch will be enabled.

3.31 All stations in group 1 have audio access to the line, but video access is restricted to the highest priority video station off-hook.

3.32 Groups 2 through 9 operate in the same way as Group 1. All groups higher or lower in the chain will be locked out except in the case of simultaneous line seizure in which case the lowest numbered group will gain access. Any group which has seized the line is thus the controlling group.

3.33 *Dialing (Audio):* The condition of the common control and group switching circuit does not change during dialing and normal key telephone service is provided via the line circuit.

- 3.34 *Dialing (Video):*** When a video call is dialed by a video station, the line circuit responds to VSS and changes to video mode. The line circuit now changes station lamps from white to red and operates the previously enabled group video switch.
- 3.35 *Operation of a video switch:***
- (a) Connects the video quad from the common cable equalizer to the calling video station and turns on its display unit.
 - (b) Isolates video from all lower priority stations in the group.
 - (c) Removes the video idle line termination.
- 3.36** If a video call is placed by an audio station, no video switch will operate until a video station in the group picks up the line. The video switch in a group switching circuit will operate only when the highest priority station in the group picks up the line.
- 3.37 *Incoming Call Attendant Mode:*** The line circuit and common control circuit function to direct audible and visual signals to the attendant station (Group 1). Lamps at other stations in all other groups light steady white.
- 3.38** When a station in any group but Group 1 attempts to seize the line at this time the tip and ring of that station will be connected to busy tone.
- 3.39** When a station in Group 1 goes off-hook, ringing is retired. All stations receive either a steady red or white light depending upon the type of call.
- 3.40 *Incoming Call, Nonattended Mode:*** All stations receive distinctive lamp signals, ringing or tone signals as desired, and all groups have access to the line on a first-come basis.
- 3.41 *Hold:*** When the controlling group places a call on HOLD, the line circuit operates as in single group line service. Busy tone is retired, and the line key releases, the video switch (if operated) associated with the controlling station releases. All stations receive a winking lamp signal and any group now has access to the line.
- 3.42 *Directed Call Transfer (Optional):*** A controlling station, after placing a call on HOLD, can signal a station (or group of stations) to pick up the call through the use of an externally mounted transfer relay which is operated by a nonlocking signal key. Interrupted ringing and flashing lamp signals indicating an audio or video call are directed to the called station. Although one group or station was signaled, a station in any group could seize the line during HOLD.
- 3.43 *Disconnect:*** When an audio station controlling the line goes on-hook, the line circuit is released and all lamps are extinguished.
- 3.44** When a lower priority video station goes on-hook, the video switch (if operated) associated with the station is released, disconnecting the video and restoring idle line termination. The remainder of the disconnect procedure is the same as for an audio station.
- 3.45** When the highest priority video station goes on-hook, the group video switch (if operated) releases. The remainder of the disconnect procedure is the same as for a lower priority video station.
- 3.46 *Switchhook Flash:*** A time-out feature in the common control circuit permits any station using the feature to retain control of the line after flashing for operator assistance. During this interval all station lamps are white.
- 3.47 *Attendant, Nonattended, or Night Service (Optional):*** As previously described, the common control circuit may be connected so that Group 1 is the attendant group with all other groups locked out on incoming calls. By the use of a locking attendant key, the common control circuit can be switched from attendant to nonattended service. In this position the key may also be used to transfer ringing to those stations to be rung on night service. All stations can receive flashing lamp signals in this mode and answer incoming calls. In all three modes outgoing calls can be placed by all stations.
- 3.48 *Add-on Conference:*** When associated with single group line service, the multigroup line must be connected as the added line (line 2) if the add-on conference circuit is internally mounted in the single group equipment. If externally mounted, the multigroup line may have the controlling station.

D. 2- or 3-Link Intercom Service

3.49 Line Seizure: A station going off-hook causes all other idle stations to be locked out during the time (12 seconds or less) required to process the service request. The call request causes an idle link circuit to be enabled (ie, connected to the single-shared register). The register circuit recognizes the requesting station (calling party) and causes it to be connected through the switch matrix to the selected link. Dial tone is then transmitted to the calling party by the link circuit.

3.50 Dialing: Video or audio calls are dialed in the normal manner. Upon receipt of the dialed number, the register makes a busy or idle test on the called station. Distinctive visual alerting signals are used to differentiate between incoming audio and video calls. One of several audible alerting signals signifying either audio or video incoming calls can be selected by the customer at the time of installation. A busy station causes busy tone to be returned to the calling party.

3.51 No indication (lamp or audible tone) is given to idle stations during the time that the register is processing a call. If an idle station attempts to originate a call during this time, the station will not receive dial tone until the register has completed processing the previous call.

3.52 Call Answering: If the called station is idle, an immediate one-half second burst of ringing signal (to the called station) and ringback tone (to the calling station) is applied. Following that, ringing and ringback occur at the normal rate of 1 second on and 4 seconds off. If the called station does not answer within 30 seconds (nominal), ringback tone is tripped and the called station is released from the ringing connection. The calling party may then abandon the call or request dial tone again.

3.53 Register Recall (RRC) (Optional): Register recall allows on off-hook intercom station to recall the register without going on-hook. Depressing the RRC key returns dial tone and allows the station to dial another code. This feature allows a calling party to add on third and fourth parties (audio only) to an established intercom call. This is accomplished by momentarily depressing the RRC key at the calling party station prior to dialing each station code.

3.54 Direct Station Selection (DSS) (Optional):

This feature permits a calling party to alert another station without dialing by momentarily depressing a DSS key associated with the desired station. Up to three stations may be selected for an audio call in this manner. The calling station is advised by appropriate audible tones of the busy or idle status of each of the called stations. If a call is in progress, the calling station may use DSS keys to add up to two additional stations.

3.55 All Links Busy: When all links are busy, a steady red lamp is provided to indicate system busy to all stations not using the intercom. If a station requests service during this time, busy tone is immediately transmitted to that station.

3.56 Station Hold (Optional): This feature, on a per station basis, permits an intercom call to be held, and also provides for lamp wink in the usual manner.

3.57 CO or PBX Add-on Transfer (Optional):

This feature, in conjunction with station hold and an add-on (AO) signal key at the controlling station, permits a call on a CO or PBX line, that appears at the controlling station, to be transferred to any other intercom station. If the CO or PBX call is video, only audio will be added on at the time the key is depressed. The controlling station selects which party (CO or intercom) he wishes to view by line key selection. When either intercom party (including the controlling station) hangs up, the CO or PBX line is transferred to the intercom and the remaining intercom party has a video and audio connection with the CO party.

3.58 Paging Control Circuit (Optional): The paging control circuit replaces the 27th station circuit. A call to the paging control circuit connects ringing voltage to the paging trunk, returns ringback tone to the calling party, and cuts the tip and ring leads though to the paging trunk circuit. The paging control circuit then automatically trips ringing and ringback tone.

3.59 PICTUREPHONE Intercom Conference Key System (PICKS) (Optional):

A nonlocking line key (CONF) is used to originate the voice switched conference. A register recall key (RRC) must be provided to permit adding third and fourth parties to the conference. Add-on transfer is required to permit the addition of a CO or PBX line to the intercom conference via a

manually operated video switch. The CONF key is also used to inhibit voice switching (leader override).

3.60 A video conference is initiated by one of the conferees depressing his CONF key. This applies ground through the switch matrix to energize only the voice operated video switches associated with the selected conferees and connect the common video quad leads of the switch matrix to the video amplifiers. The voice operated video switch performs the logic which switches the video pairs to the appropriate video amplifier during a PICKS conference.

3.61 The voice operated video switch uses "last speaker" logic. All conferees see the present speaker, except the present speaker, who sees the previous speaker. When the next speaker seizes control of the voice operated video switch, his image is seen by all other stations and the image on his display unit does not change (he sees the previous speaker). If two conferees do all the talking, the images on their display unit do not change. All other conferees see the image alternate from one speaker to another.

3.62 A manually operated video switch allows a CO or PBX line to be included in a PICKS conference. It is manually switched into the present speaker state whenever one of the conferees depresses the CO or PBX line key. This inhibits all voice switching until the CO or PBX line key is released. Voice switching is reestablished and the CO or PBX line is treated as a listener.

3.63 The Leader Override feature allows a conferee to inhibit voice switching by momentarily operating the CONF key. All other conferees then see the control station conferee while the control station continues to see the last speaker. To release control, the control station momentarily operates the CONF key a second time.◆

4. TESTS AND MAINTENANCE

2C VIDEO TELEPHONE STATION

4.01 Refer to Section 518-800-501 for the use of the 136A test set which has been provided to make operational checks of the station at time of installation and to isolate troubles to the major components of the station when necessary.

1P2 KEY TELEPHONE SYSTEM

4.02 For maintenance and test procedures refer to Section 518-800-505. For single group or multigroup line service, and single link intercom and for 2- or 3-link intercom, refer to Section 518-800-507.

5. VIDEO LOOP ALIGNMENT

5.01 The Cable Equalizer Test Set (CETS) has been provided to check and adjust the alignment of the video loop at the time of installation and periodically afterwards. See Section 518-800-510.

5.02 The Fault Locating Test Set (FALTS) is used in conjunction with the CETS to isolate troubles when required. See Section 518-800-512.

5.03 The CETS is used whether the cable equalizers are located in the 2C Video Telephone Station or in the 1P2 KTS.

6. REFERENCES

6.01 For more detailed information refer to the following documents.

- | | |
|--------------------|--|
| SD-69494-01, Iss 3 | Key Telephone System No. 1A2— 565HK and 2565HK Telephone Set Circuit |
| SD-69561-01, Iss 2 | Key Telephone Systems No. 1A2— Conference Circuit |
| SD-69567-01, Iss 8 | ◆Key Telephone System No. 1A2— Dial Selective Intercommunicating Line Circuit◆ |
| SD-69590-01, Iss 2 | ◆Key Telephone System No. 1A2— Auxiliary Ringup Power Failure Circuits◆ |
| SD-69595-01, Iss 7 | Key Telephone System No. 1A2— TOUCH-TONE Adapter Circuit |
| SD-69605-01, Iss 1 | Key Telephone System No. 1P2— Single Group CO or PBX Line Circuit for PICTUREPHONE Service |

SECTION 518-800-100

| | | | |
|-------------------|---|-------------------|--|
| SD-69606-01,Iss 3 | Key Telephone System No. 1P2— Single Link Intercom for PICTUREPHONE Service | SD-69621-01,Iss 3 | Key Telephone System No. 1P2— 650A Key Service Unit for PICTUREPHONE Service |
| SD-69607-01,Iss 2 | Key Telephone System No. 1P2— Multigroup CO or PBX Line Circuit for PICTUREPHONE Service | SD-69622-01,Iss 3 | Key Telephone System No. 1P2—J53051A Bay for PICTURE- PHONE Service |
| SD-69618-01,Iss 2 | ◆Key Telephone System Cable Equalizer for PICTUREPHONE Service◆ | SD-69623-01,Iss 3 | Key Telephone System No. 1P2—J53051B Bay for PICTURE- PHONE Service |
| SD-69620-01,Iss 3 | ◆2C Video Telephone Circuit◆ | SD-69632-01,Iss 3 | ◆Key Telephone System No. 1P2— 2- or 3-Link Intercom for PICTUREPHONE Service◆ |