

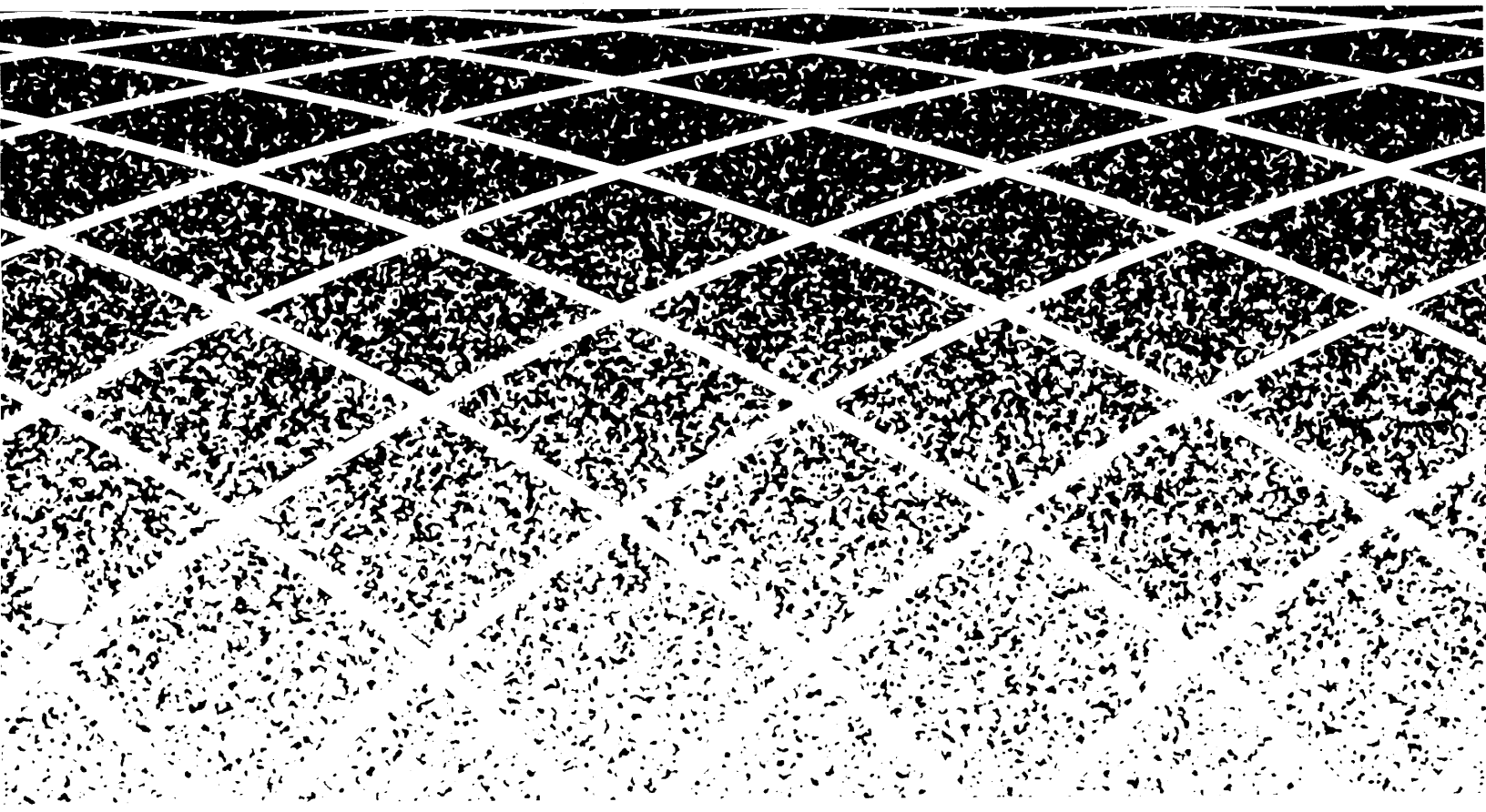

MERLIN LEGEND[®]
Communications System
Basic Rate interface
Supplemental Reference



**Copyright © 1994, AT&T
All Rights Reserved
Printed in U.S.A.**

**AT&T 555-601-111
Issue 1
October 1994**

Notice

Every effort was made to ensure that the information in this book was complete and accurate at the time of printing. However, information is subject to change.

See Appendix B, "Customer Support Information," for important information.

Security of Your System: Preventing Toll Fraud

As a customer of a new telephone system, you should be aware that there exists an increasing problem of telephone toll fraud. Telephone toll fraud can occur in many forms, despite the numerous efforts of telephone companies and telephone equipment manufacturers to control it. For important information regarding your system and toll fraud, see Appendix B, "Customer Support Information."

Federal Communications Commission Statement

This equipment has been tested and found to comply with the limits for a Class A digital device, pursuant to Part 15 of the FCC Rules. These limits are designed to provide reasonable protection against harmful interference when the equipment is operated in a commercial environment. This equipment generates, uses, and can radiate radio frequency energy and, if not installed and used in accordance with the instruction manual, may cause harmful interference to radio communications. Operation of this equipment in a residential area is likely to cause harmful interference, in which case the user will be required to correct the interference at his own expense. For further FCC information, see Appendix B, "Customer Support Information."

Trademarks

5ESS, MERLIN, MERLIN LEGEND, MLX-10, MLX-10D, MLX-20L, MLX-28D, and Magic On Hold are registered trademarks; AUDIX Voice Power, FAX Attendant System, HackerTracker, MERLIN MAIL, PassageWay, PictureTel, and Vistium are trademarks of AT&T in the U.S. and other countries.

Ordering Information

The ordering number for this document is 555-601-111. To order this document, call the AT&T GBCS Publication Fulfillment Center at 1-800-457-1235 or fax your request to 1-800-457-1764. For more information about AT&T documents, refer to the section entitled, "Related Documents" in "About This Book." The *Pocket Reference*, listed in that section, provides full ordering information for replacement parts, accessories, and other compatible equipment; or, contact your AT&T representative.

Support Telephone Number

In the continental U.S., AT&T provides a toll-free customer helpline 24 hours a day. Call the AT&T Helpline at 1-800-628-2888 if you need assistance when installing or using your system.

Outside the continental U. S., contact your local AT&T representative.

Warranty

AT&T provides a limited warranty on this product. Refer to "Limited Warranty and Limitation of Liability" in Appendix B, "Customer Support Information."

Contents

About this Book

■ Intended Audience	xi
■ Conventions Used	xi
■ Related Documents	xii
■ How to Comment on This Document	xiv

Overview

■ Introduction	1-2
■ ISDN and BRI	1-3
■ System Overview	1-4
■ Applications	1-8
■ Modes of Operation	1-10
■ Call Handling	1-11
■ BRI Features	1-14

Equipment and Operation

■ Equipment Requirements for MERLIN LEGEND BRI System	2-2
■ 800 CO-BRI Module	2-3
■ Installation of Equipment	2-7
■ Upgrading the MERLIN LEGEND System	2-9
■ Telephones	2-13
■ Adjuncts	2-14
■ Applications	2-15

Features

■ All-Call Privacy/Per-Call Privacy	3-2
■ Automatic Callback	3-6
■ Automatic Recall	3-10
■ Calling Party Number/Billing Number	3-13
■ CO Transfer	3-15
■ Customer Originated Trace	
■ Multi-Level Precedence and Preemption (MLPP)	3-23

Contents

Planning

■ Planning Overview	4-1
■ System Planning Forms	4-2
■ Control Unit Planning	4-5
■ Line Connections	4-7
■ Line Options	4-8
■ Assigning Telephone Buttons	4-16
■ Features	4-17

System Programming

■ Basic Programming Considerations	5-2
■ Service Profile Identifier (SPID)	5-3
■ Clock Synchronization	5-6
■ BRI Timers	5-10
■ BRI Access Button	5-13
■ System Programming Reports	5-19

Maintenance

■ BRI Maintenance	6-2
■ Accessing Maintenance Screens	6-3
■ Demand Tests	6-4
■ BRI Module and Clock Synchronization	6-13
■ Port Screens — Digital Subscriber Lines	6-16
■ Error Logs and Error Messages	6-18

Contents

A	Planning Forms	A-1
B	Customer Support Information	B-1
AB	Abbreviations	AB-I
GL	Glossary	GL-1
IN	Index	IN-I

Figures

Overview

1-1	MERLIN LEGEND BRI Capabilities	1-2
1-2	PRI VS. BRI	1-3
1-3	800 CO-BRI Module	1-5
1-4	Directory Number Mapping	1-6
1-5	Placement of BRI Access Button on an MLX Telephone	1-7

Equipment and Operation

2-1	800 CO-BRI Module	2-4
2-2	LEDs on an 800 CO-BRI Module	2-5
2-3	Installing the 800 CO-BRI Module	2-8
2-4	Installing the 2.B Feature Module	2-10

Features

3-1	MLX Display Telephone Calling Party Number Information	3-14
-----	--	------

System Programming

5-1	BRI Information Report	5-19
-----	------------------------	------

Tables

Equipment and Operation

2-1	800 CO-BRI Module Specifications	2-3
2-2	800 CO-BRI Module LEDs	2-5
2-3	Pin Assignments for 8-Position Jack on an 800 CO-BRI Module	2-6
2-4	800 CO-BRI Module LEDs	2-5

Planning

4-1	System Planning Forms Needed for BRI Planning	4-3
4-2	Timers	4-12

System Programming

5-1	BRI Timer Settings	5-3
5-2	Timers	5-12

Maintenance

6-1	Error Conditions	6-19
6-2	BRI Error Messages	6-24



The exclamation point in an equilateral triangle is intended to alert the user to the presence of important operating and maintenance (servicing) instructions in the literature accompanying the product.

IMPORTANT SAFETY INSTRUCTIONS

When installing telephone equipment, always follow basic safety precautions to reduce the risk of fire, electrical shock, and injury to persons, including:

- Read and understand all instructions.
- Follow all warnings and instructions marked on or packed with the product.
- Never install telephone wiring during a lightning storm.
- Never install a telephone jack in a wet location unless the jack is specifically designed for wet locations.
- Never touch uninsulated telephone wires or terminals unless the telephone wiring has been disconnected at the network interface.
- Use caution when installing or modifying telephone lines.
- Use only AT&T-manufactured MERLIN LEGEND Communications System circuit modules, carrier assemblies, and power units in the MERLIN LEGEND Communications System control unit.
- Use only AT&T-recommended/approved MERLIN LEGEND Communications System accessories.
- If equipment connected to the analog extension modules (008, 408, 408 GS/LS) or to the MLX telephone modules (008 MLX, 408 GS/LS-MLX) is to be used for in-range out-of-building (IROB) applications, IROB protectors are required.
- Do not install this product near water, for example, in a wet basement location.
- Do not overload wall outlets, as this can result in the risk of fire or electrical shock.
- The MERLIN LEGEND Communications System is equipped with a 3-wire grounding-type plug with a third (grounding) pin. This plug will fit only into a grounding-type power outlet. This is a safety feature. If you are unable to insert the plug into the outlet, contact an electrician to replace the obsolete outlet. Do not defeat the safety purpose of the grounding plug.
- The MERLIN LEGEND Communications System requires a supplementary ground.

- Do not attach the power supply cord to building surfaces. Do not allow anything to rest on the power cord. Do not locate this product where the cord will be abused by persons walking on it.
- Slots and openings in the module housings are provided for ventilation. To protect this equipment from overheating, do not block these openings.
- Never push objects of any kind into this product through module openings or expansion slots, as they may touch dangerous voltage points or short out parts, which could result in a risk of fire or electrical shock. Never spill liquid of any kind on this product.
- Unplug the product from the wall outlet before cleaning. Use a damp cloth for cleaning. Do not use cleaners or aerosol cleaners.
- Auxiliary equipment includes answering machines, alerts, modems, and fax machines. To connect one of these devices, you must first have a Multi-Function Module (MFM).
- Do not operate telephones if chemical gas leakage is suspected in the area. Use telephones located in some other safe area to report the trouble.



WARNING:

- *For your personal safety, DO NOT install an MFM yourself.*
- *ONLY an authorized technician or dealer representative shall install, set options, or repair an MFM.*
- *To eliminate the risk of personal injury due to electrical shock, DO NOT attempt to install or remove an MFM from your MLX telephone. Opening or removing the module cover of your telephone may expose you to dangerous voltages.*

SAVE THESE INSTRUCTIONS

About This Book

This document is a supplement to the standard documentation for the MERLIN LEGEND® Communications System and provides the user with information specific to the use of a MERLIN LEGEND Basic Rate Interface (BRI) system. This information includes the equipment, features, programming procedures, planning procedures, and maintenance procedures that differ from the standard MERLIN LEGEND system.

Intended Audience

This book is intended for use as a reference by anyone needing such information, including support personnel, sales representatives, system managers, and users of the MERLIN LEGEND BRI system. It is also intended for system technicians who are responsible for system installation, maintenance and troubleshooting.

Conventions Used

Certain type fonts and styles act as visual cues to help you rapidly understand the information presented:

<u>Example</u>	<u>Purpose</u>
It is very important that you follow these steps. You <i>must</i> attach the wristband before touching the connection.	Italics indicate emphasis.
The part of the headset that fits over one or both ears is called a <i>headpiece</i> .	Italics also set off special terms.

If you press the **Feature** button on an MLX display telephone, the display lists telephone features you can select. A programmed Auto Dial button gives you instant access to an inside or outside number.

Choose Ext Prog from the display screen.

To activate Call Waiting, dial *11.

The names of fixed-feature, factory-imprinted buttons appear in bold. The names of programmed buttons are printed as regular text.

Plain constant-width type indicates text that appears on the telephone display or PC screen.

Constant-width type in italics indicates characters you dial at the telephone or type at the PC,

Product Safety Labels

Throughout these documents, hazardous situations are indicated by an exclamation point inside a triangle and the word *caution* or *warning*.

A WARNING:

Warning indicates the presence of a hazard that could cause death or severe personal injury if the hazard is not avoided.

A CAUTION:

Caution indicates the presence of a hazard that could cause minor personal injury or property damage if the hazard is not avoided.

Related Documents

in addition to this book, the documents listed below are part of the documentation set. Within the continental United States, these documents can be ordered from the GBCS Publications Fulfillment Center by calling 1-800-457-1235.

Document	Title
	System Documents
555-601-110	<i>BRI Access Button Quick Reference</i>
555-601-111	<i>BRI Supplemental Reference</i>
555-601-112	<i>BRI Provisioning and Planning</i>
555-620-110	<i>Feature Reference</i>
555-620-115	<i>Equipment and Operations Reference</i>
555-640-141	<i>Installation</i>
555-620-116	<i>Pocket Reference</i>
555-620-111	<i>System Programming</i>
555-620-112	<i>System Planning</i>
555-620-113	<i>System Planning Forms</i>
	Telephone User Support
555-601-110	<i>BRI Access Button Quick Reference</i>
555-620-122	<i>MLX-10D, MLX-28D, and MLX-20L Display Telephones User's Guide</i>
555-620-123	<i>MLX-10D, MLX-28D, and MLX-20L Display Telephones Quick Reference</i>
555-620-150	<i>MLX- 10D Display Telephone Tray Cards (6 cards)</i>
555-620-152	<i>MLX-28D and MLX-20L Telephone Tray Cards (5 cards)</i>
555-620-124	<i>MLX-10 Nondisplay Telephone User's Guide</i>
555-620-151	<i>MLX-10 Nondisplay Telephone Tray Cards (6 cards)</i>
555-620-120	<i>Analog Multiline Telephones User's Guide</i>
555-620-121	<i>Analog Multiline Telephones Quick Reference</i>
555-620-126	<i>Single-Line Telephones User's Guide</i>
555-620-127	<i>Single-Line Telephones Quick Reference</i>
555-620-128	<i>MLC-5 Cordless Telephone Quick Reference</i>
	System Operator Support
555-620-134	<i>MLX Direct-Line Consoles Operator's Guide</i>
555-620-135	<i>MLX Direct-Line Consoles Quick Reference</i>
555-620-132	<i>Analog Direct-Line Consoles Operator's Guide</i>
555-620-133	<i>Analog Direct-Line Consoles Quick Reference</i>
555-620-136	<i>MLX Queued Call Console Operator's Guide</i>
555-620-137	<i>MLX Queued Call Console Quick Reference</i>
	Miscellaneous User Support
555-620-130	<i>Calling Group Supervisor's Guide</i>
555-620-131	<i>Calling Group Supervisor's Quick Reference</i>
555-620-129	<i>Data User's Guide</i>

Document	Title
	Software-Linked Information Products
ST-21 29-72	<i>Vistium PV 1200 Installation Guide</i>
ST-2129-73	<i>Vistium PV 1200 User's Guide</i>
ST-2130-88	<i>Vistium PV 1300 Installation Guide</i>
ST-2130-89	<i>Vistium PV 1300 User's Guide</i>
	Documentation for Qualified Technicians
555-620-140	<i>Installation, Programming, & Maintenance (IP&M) Binder</i> (consists of 555-620-141, 555-620-142, 555-620-143, and 555-620-144)
555-620-141	<i>Installation</i>
555-620-142	<i>System Programming & Maintenance (SPM)</i>
555-620-143	<i>Maintenance & Troubleshooting</i>
555-620-144	<i>Programming Summary</i>

How to Comment on This Document

We welcome your comments, both good and bad. Please use the feedback form on the next page to let us know how we can continue to serve you. If the feedback form is missing, write directly to:

Documentation Manager
AT&T
211 Mount Airy Road
Room 2W226
Basking Ridge, NJ 07920.

FEEDBACK FORM
MERLIN LEGEND® BRI Communications System

Title: MERLIN LEGEND BRI Communications System Supplemental Reference
 Order No.: 555-601-111 Date: **October 1994**

1. Please rate the effectiveness of this book in the following areas:

	Excellent	Good	Fair	Poor	Not Applicable
Ease of Use					
Clarity					
Completeness					
Accuracy					
Organization					
Apearance					
Examples					
Illustrations					
Overall Satisfaction					

2. Please check ways you feel we could improve this book:

- ◆ Improve the overview
- ◆ Add more examples
- ◆ Add troubleshooting information
- ◆ Improve the table of contents
- ◆ Add more detail
- ◆ Make it less technical
- ◆ Improve the organization
- ◆ Make it more concise
- ◆ Add more/better quick reference aids
- ◆ Include more illustrations
- ◆ Add more step-by-step procedures
- ◆ Improve the index/glossary
- ◆ Other _____

3. What did you like most about this book?

4. Feel free to write any comments below or on an attached sheet.

If we may contact you about your comments, please complete the following:

Name: _____ Telephone Number: _____
 Company/Organization: _____ Date: _____
 Address: _____

Send completed forms to: Documentation Manager, AT&T, 211 Mount Airy Road,
 Room 2W226, Basking Ridge, NJ 07920. Fax: (908) 953-6912.

THIS FORM MAY BE PHOTOCOPIED

Overview

1

This chapter introduces the MERLIN LEGEND®BRI Communications System. In addition to a short discussion of Integrated Services Digital Network (ISDN) and Basic Rate Interface (BRI), the chapter covers the basic hardware and software requirements and the functions and features of the system. Also included are brief descriptions of the BRI features supported by the MERLIN LEGEND BRI system.

Introduction

To obtain faster rates and precise data, equipment must be able to transmit digitally. Like Primary Rate Interface (PRI), BRI is a standard protocol for accessing Integrated Services Digital Network (ISDN) services. By using BRI, the MERLIN LEGEND Communications System can connect with the speed and accuracy of ISDN services.

BRI lines offer the capability of voice, high-speed data, local area network (LAN) interconnection, and video transmission (see Figure 1-1). In addition to the standard features offered by other releases of the MERLIN LEGEND Communications System, the MERLIN LEGEND BRI system offers the ability to subscribe to several BRI features. Other BRI features have applications specific to Federal Government telephone networks.

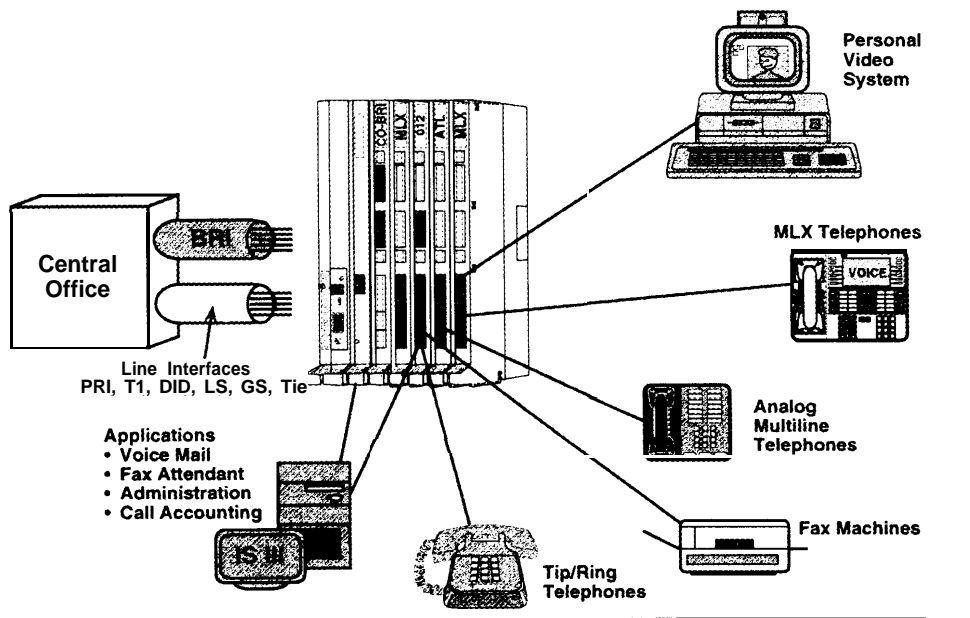

Figure 1-1. MERLIN LEGEND BRI Capabilities

NOTE:

The MERLIN LEGEND system does not support BRI when the MERLIN LEGEND BRI lines are shared by ISDN stations outside the system. "Shared" means that the same lines are connected to more than one station.

ISDN and BRI

To understand the BRI option, the user should be familiar with the Integrated Services Digital Network (ISDN) and the Basic Rate Interface (BRI).

ISDN

The Integrated Services Digital Network (ISDN) is a digital network interface used worldwide for the transmission of voice, data, video, and other services simultaneously over standard telephone wires. It is the leading standard in the world for digital transmission.

With ISDN, a user can talk on the telephone while receiving and sending faxes or data. Because it is digital, ISDN has faster and more accurate data transmission, calling information, and more reliable establishment of calls. ISDN is excellent for video, teleconferencing, and telemarketing.

BRI

Basic Rate Interface (BRI) is a protocol within the ISDN standard. Because it is a station-side protocol, BRI also offers access to other groups of services, such as central office (CO) Transfer and Local Area Signaling Services (LASS) features, which are described later.

While a Primary Rate Interface (PRI) line consists of 23 bearer channels (B-channels) and one data channel (D-channel), a BRI line has two B-channels and one D-channel. The B-channels carry the user information (including data), and the D-channel controls the B-channel communication and initializes ISDN lines. Each B-channel on a BRI line has a capacity of 64 Kbps, and each D-channel has a capacity of 16 Kbps. (See Figure 1-2.)

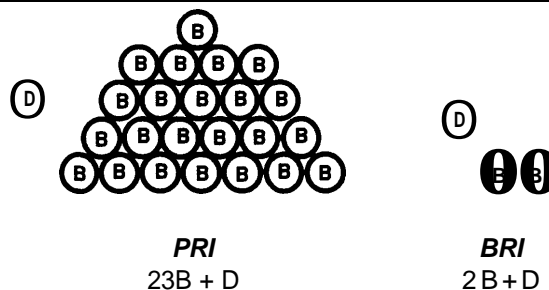

Figure 1-2. PRI vs. BRI

System Overview

A MERLIN LEGEND BRI system has specific requirements and components different from a standard MERLIN LEGEND system.

Hardware and Software Requirements

A MERLIN LEGEND system must have an 800 CO-BRI module to connect to BRI facilities. This module is the interface that connects BRI lines from a 5ESS® G8 central office to the MERLIN LEGEND system. In addition, the Processor module must contain the 2. B Feature module.

NOTE:

If a new MERLIN LEGEND BRI system has been purchased, the 2.B Feature module already resides in the Processor module. If a MERLIN LEGEND system is upgraded to a MERLIN LEGEND BRI system, the 2.B Feature module must be installed in the existing Processor module. (See “installing the 2.B Feature Module” in Chapter 2.)

The MERLIN LEGEND BRI system supports connectivity to a 5ESS Custom Central Office switch servicing the AT&T Custom BRI protocol. The 5ESS central office (CO) must be running 5ESS Generic 8 Custom (5E8) or later software.

The MERLIN LEGEND system must be a base of Release 2.0 or higher to be upgraded to MERLIN LEGEND BRI software release 2.B, and to operate properly with an 800 CO-BRI module. However, a 2.B Feature module can be used in a Release 1.0 Processor module if the Release 1.0 software is upgraded by using the Convert utility of the System Programming and Maintenance (SPM) software.

Ordering BRI Lines

BRI services and features ordered by the customer are configured into a package by the CO. This package is called a User Service Order Profile (USOP). A USOP contains the information needed to provide BRI service from the CO to the MERLIN LEGEND system.

Along with a USOP, the CO provides up to two Service Profile Identifiers (SPIDs) to each BRI line, or Digital Subscriber Line (DSL), coming into the MERLIN LEGEND system at the time of subscription. A SF'ID associates a line on the system with a USOP. The MERLIN LEGEND line's Directory Number is usually a subset of the SPID.

Also at the time of subscription, the type of terminal configuration, in this case Type D, is specified. Although the 5ESS Generic 8 Custom (5E8) software supports two types of services over BRI lines (Point-to-Point and Point-to-Multipoint), the MERLIN LEGEND system only supports Point-to-Multipoint.

800 CO-BRI Module

The 800 CO-BRI (Central Office-Basic Rate Interface) module is the MERLIN LEGEND system interface to BRI lines from the central office. At least one 800 CO-BRI module must be in the system for the system to be connected to BRI lines. Up to five 800 CO-BRI modules can be placed in a system (or any combination of line modules up to the system maximum of 80 lines).



CAUTION:

Because of limitations with the 391A, 391A 1, and 391A2 power supplies, the number of 800 CO-BRI modules plus 100D modules cannot exceed three per carrier.

Each 800 CO-BRI module has eight ports; each port supports two MERLIN LEGEND lines, for a total of 16 lines per module (see Figure 1-3).

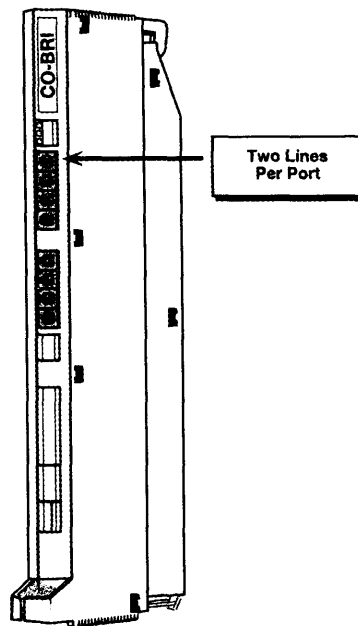

Figure 1-3. 800 CO-BRI Module

Each BRI line, called a Digital Subscriber Line (DSL), coming into the MERLIN LEGEND system contains two Directory Numbers (DNs), one for each B-channel. Usually the Directory Number is the number that is dialed to reach the destination.

The MERLIN LEGEND system maps the Directory Number (DN) to a line number in the Dial Plan. For example, if the 800 CO-BRI module is the first module in the system, DN1 is mapped to Line 801, the first line in the MERLIN LEGEND system. DN2 is mapped to 802, and soon for each DN (see Figure 1-4). A telephone with Line 801 rings any time a call arrives to DN1. Subsequent calls to the same DN can be handled by the 5ESS Multi-Line Hunt Group feature (if the user has subscribed to this feature).

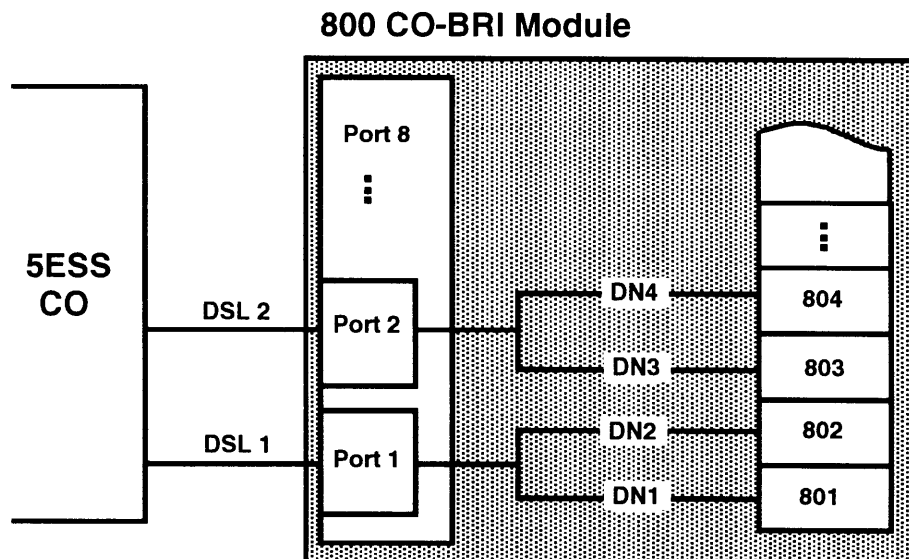

Figure 1-4. Directory Number Mapping

Every BRI line physically plugged into a port on an 800 CO-BRI module equates to two MERLIN LEGEND lines. This is similar to the way one physical PRI line plugged into a 100D module becomes 23 lines on the MERLIN LEGEND system.

Overview

BRI Access Button

The BRI Access button is a button programmed on the telephone console in the same way as a System Access or Intercom button. The BRI Access button is used to initiate a CO Transfer and to identify the last BRI line that placed or received a call. Administered via Centralized Telephone Programming (see Chapter 5, "System Programming"), the BRI Access button can be programmed on any of the first ten buttons on an analog multiline or digital multiline (MLX) telephone (see Figure 1-5).

NOTE:

There can be only one BRI Access button on a telephone.

This identification is used for Local Area Signaling Services (LASS) features (see the section "BRI Features" in this chapter).

Program any of the first ten buttons on the telephone as the BRI Access button.

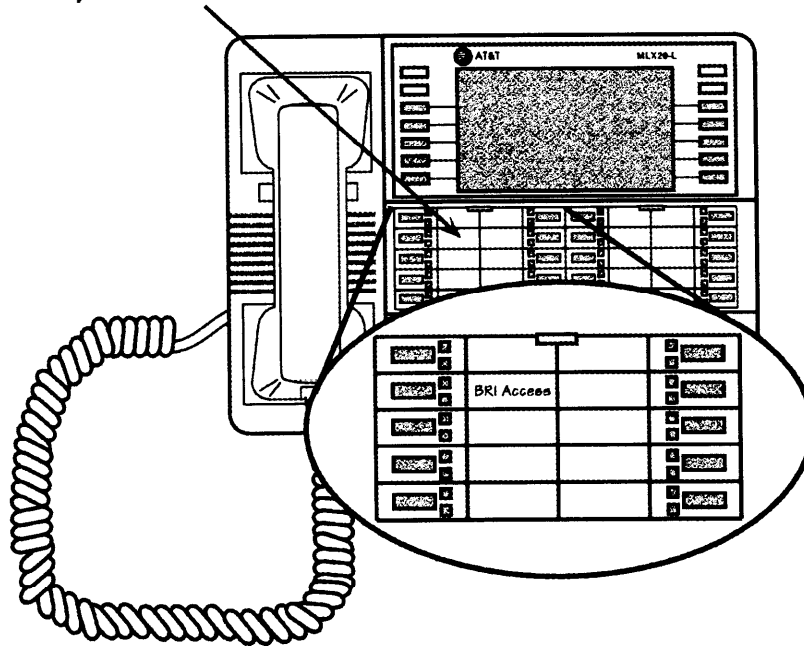

Figure 1-5. Placement of BRI Access Button on an MLX Telephone

Applications

The MERLIN LEGEND BRI system supports almost all of the applications supported by a standard MERLIN LEGEND system. These applications include:

- AT&T Attendant
- DOS Call Accounting System (CAS)
- CAS for Windows
- Call Accounting Terminal (CAT)
- Call Management System (CMS)
- Conversant Voice Information Systems (CVIS) INTRO
- HackerTracker™ System
- Integrated Solution II Release 1.0
 - Integrated Voice Power Automated Attendant Release 1.1
 - AUDIX™ Voice Power (AVP) 2.1
 - MERLIN LEGEND Call Accounting System (CAS) Release 1.0
 - System Programming and Maintenance (SPM) Release 3.18

- Integrated Solution III
 - AUDIX Voice Power (AVP) Release 2.1.1
 - AT&T FAX Attendant™ System (FA) Release 2.1.1
 - MERLIN LEGEND Integrated Solution Call Accounting System (CAS) Release 1.0
 - System Programming and Maintenance (SPM) Release 3.18
 - Integrated Administration

- MERLIN Identifier

- MERLIN MAIL™

- MERLIN MAIL Multi-Lingual Release

- PassageWay™

NOTE:

PassageWay Release 1.0 does not recognize the BRI Access button.
Release 2.0 is recommended.

- PictureTel™ 4000 Group Video system

- Vistium™ 1200/1300 Personal Video system

Modes of Operation

The MERLIN LEGEND BRI system operates in Key mode and, with limitations, in Hybrid/PBX mode. Behind Switch mode is not supported.

Key Mode

The MERLIN LEGEND BRI system was developed primarily to work in Key mode. Consequently, it functions fully in Key mode with the following exception: BRI lines will not default on stations or Direct Line Consoles (DLCs). They must be assigned during system programming.

Hybrid/PBX Mode

BRI is supported in Hybrid/PBX mode with these limitations:

- Queued Call Consoles (QCCs) cannot have BRI Access buttons and therefore cannot initiate CO Transfer (see the “BRI Features” section in this chapter),
- BRI lines in pools should not be mixed with other types of lines (loop-start, ground-start, PRI, etc.).
- All BRI lines in a pool should be configured by the central office (CO) the same way. In other words, the User Service Order Profile should be the same. Otherwise, the user can get confused.
- Since there is no way to identify the last Directory Number used for a call on System Access or Pool buttons, Local Area Signaling Services (LASS) features should not be used on calls made to or from these buttons. LASS features should be used only on Personal Lines (see the “BRI Features” section in this chapter).
- No Automatic Route Selection or Pool dialout code can be used when a Transfer destination is dialed on a BRI Access button.
- BRI lines will not default into any pool on system startup. They must be assigned during system programming.

Call Handling

Placing and receiving calls on a BRI line is the same as placing and receiving calls on loop-start or ground-start lines. Making BRI digital data calls is the same as making Primary Rate Interface (PRI) digital data calls.

Incoming Calls

An incoming call to a BRI line can terminate on Personal Line buttons, Direct Pool Termination (DPT) buttons, Calling Groups, and the Queued Call Console (QCC) queue.

Outgoing Calls

When a user lifts the receiver and presses a BRI line button on a telephone, the MERLIN LEGEND system sets up a call to the 5ESS central office (CO). The button's light-emitting diode (LED) turns to green to show that the line is active. The CO provides dial tone. As the user dials digits, they are sent to the CO.

Like other lines, a BRI line can be accessed via a DPT button or via a System Access button through pool access codes.

Like other lines, a BRI line can be accessed via Automatic Route Selection (ARS). ARS routes calls over outside lines according to the number dialed and the lines available. As with PRI facilities, a user can take advantage of ARS routing for the type of call (voice or data). For example, if data is frequently sent to a particular number in another area of the country, ARS can route calls to that number over high-speed data lines.

Hold

An active call on a BRI line can be placed on hold by using the MERLIN LEGEND Hold feature. All call appearances (such as LEDs) are the same as for other non-BRI lines.

Conference

Calls on BRI lines can be part of a conference call, but the conference is processed by the MERLIN LEGEND system, not by the 5ESS central office (CO). The MERLIN LEGEND system determines the number of active parties on the call.

Like a standard MERLIN LEGEND system, the MERLIN LEGEND BRI system supports up to five people on a conference: two within the system, two outside the system, and the call originator.

NOTE:

If a MERLIN LEGEND user is part of a conference established by an outside party via the CO Conference feature, the MERLIN LEGEND system may play MOH (if so programmed) when the MERLIN LEGEND user puts the call on hold.

Transfer

A user can transfer calls two ways on a MERLIN LEGEND BRI system. One way is to transfer calls by using the standard MERLIN LEGEND Transfer feature. The MERLIN LEGEND Transfer feature works the same with BRI lines as with other lines. With this Transfer feature a user can transfer the following calls:

- Intercom call to a MERLIN LEGEND station

- CO call to a MERLIN LEGEND station

- Intercom call to a station outside the system

- CO call to a station outside the system

This last transfer, called Trunk-to-Trunk Transfer, ties up both CO facilities involved in the transfer.

The second way of transferring calls to outside destinations is to use the CO Transfer feature. With CO Transfer, the user can connect two outside parties without tying up the BRI lines that were used to establish the connection. In essence, when CO Transfer is used, the transfer bounces back to the 5ESS CO, letting the CO handle it and thereby freeing the BRI lines to handle more calls.

For more information, see the “BRI Features” section later in this chapter.

Overview

Recall

Recall is not recognized by the 5ESS central office (CO) on BRI lines. Therefore, pressing the recall button on a telephone is ignored by the CO.

Remote Access

BRI lines can be programmed to use the Remote Access feature.

BRI Features

By using Basic Rate Interface (BRI) lines, the MERLIN LEGEND system can use features offered by the 5ESS central office. The BRI features described below are supported by the MERLIN LEGEND system. The Multi-Level Precedence and Preemption (MLPP) feature can be used only on a private configured network and, therefore, is used primarily by the Federal Government.

NOTE:

All BRI features are ordered from the central office (CO) at the time of subscription for BRI lines. Depending on the CO, the features may be available under a different name and voice prompts may vary.

All-Call Privacy/Per-Call Privacy

The All-Call Privacy feature prevents or allows the Calling Party Number/Billing Number (CPN/BN) to be sent by the central office when an outgoing call is made on a BRI line. If All-Call Privacy is activated for that line, the CPN/BN is not sent. If All-Call Privacy is *not* activated, the CPN/BN is sent.

Per-Call Privacy overrides the All-Call Privacy status for the next call only. For example, if Per-Call Privacy is used on a line that has All-Call Privacy activated (preventing a number being sent), the number is sent for the next call only.

Calling Party Number/Billing Number

The Calling Party Number/Billing Number (CPN/BN) feature provides incoming calling party number information that identifies the originator of a call in the call-handling displays of MLX telephones. If the MERLIN LEGEND system subscribes to this BRI feature, each incoming call to the system over a BRI line can be accompanied either by the calling party number or by the billing number of the calling party supplied by the network. The billing number is the telephone billing number for the department or company.

Preference for a calling party number or a billing number can be specified during subscription to the BRI features.

NOTE:

If the calling party subscribes to the 5ESS feature All-Call Privacy, no number is received.

CO Transfer

When a BRI call comes in from the 5ESS central office (CO) and the user needs to transfer the call back outside the MERLIN LEGEND system, he or she can press the Transfer button, press the BRI Access button, and then dial the destination station. The user presses the Transfer button again to complete the transfer or hangs up. Once the transfer is complete, the BRI line to the MERLIN LEGEND system is free for additional call handling. By contrast, the standard MERLIN LEGEND Transfer feature ties up both the incoming and outgoing lines for the duration of the call.

Local Area Signaling Services Features

Local Area Signaling Services (LASS) features are a group of central office features that use BRI lines to provide MERLIN LEGEND users with call-management capabilities. The MERLIN LEGEND BRI system provides access to three LASS features:

- Automatic Callback
- Automatic Recall
- Customer Originated Trace

Automatic Callback

The Automatic Callback feature allows a user to call back the last number received on a given BRI line. If the far-end is busy, the 5ESS CO “camps” or queues the call and calls the user when the call can be completed. To access Automatic Callback, the user dials a feature access code provided by the CO.

Automatic Recall

The Automatic Recall feature allows a user to call back the last outgoing call he or she dialed on a given BRI line. If the far-end is busy, the 5ESS CO “camps” or queues the call and calls the user when the call can be completed. To access Automatic Recall, the user dials a feature access code provided by the CO.

Customer Originated Trace

The Customer Originated Trace feature allows a user to trace the origin of the last call received on a given BRI line. This information is stored at the 5ESS CO. To retrieve it, the user must contact a CO representative.

NOTE:

Use of the Customer Originated Trace feature depends upon the practices of the local law-enforcement agencies. The local telephone company should be contacted for details on the availability and use of this feature.

Multi-Level Precedence and Preemption

By using the Multi-Level Precedence and Preemption (MLPP) feature, the calling party can identify certain calls as priority calls. Such calls ring with a priority ring and, by government convention, must be answered by either the called party or a designated backup station. At the CO, an MLPP call can “tear down” or preempt a non-priority call to complete the priority call.

NOTE:

The use of the Multi-Level Precedence and Preemption feature requires a private network. As such, MLPP is used primarily by the Federal Government.

Equipment and Operation

2

This chapter describes the hardware used in and with the MERLIN LEGEND BRI system and outlines the procedures for installation.

Except as noted, a MERLIN LEGEND BRI system supports the same telephones and adjuncts as a standard MERLIN LEGEND Communications System.

Equipment Requirements for a MERLIN LEGEND BRI System

The hardware unique to a MERLIN LEGEND BRI system consists of:

- 800 CO-BRI module
- Feature module with 2.B software

If the entire MERLIN LEGEND BRI system is purchased new, the Feature module is already placed in the new Processor module. For procedures for installing a BRI module, refer to the section "installation of Equipment."

If the existing MERLIN LEGEND system is being upgraded to a MERLIN LEGEND BRI system, the 2.B Feature module must be installed in the existing Processor module. For installing the Feature module, refer to the section "Upgrading to a MERLIN LEGEND BRI System."

800 CO-BRI Module

The 800 CO-BRI module serves as the Integrated Services Digital Network (ISDN) Basic Rate, two-wire U-interface between the MERLIN LEGEND system and the central office (CO) Basic Rate Interface (BRI) lines (see Figure 2-1).

The 800 CO-BRI module consists of eight ports. Each port supports a BRI line (also called a Digital Subscriber Line or DSL). Each DSL maps to two MERLIN LEGEND lines and supports two Directory Numbers, for a total of 16 lines or Directory Numbers per 800 CO-BRI module (see Figure 2-1). Up to five 800 CO-BRI modules can exist in a system (80 lines). The system supports a maximum of two 100D modules.



CAUTION:

Because of limitations with the 391A, 391A 1, and 391A2 power supplies, the number of 800 CO-BRI modules plus 100D modules in a carrier cannot exceed three.

Each DSL operates at 160 kbps with the following allocation:

- Two 64-kbps B-channels
- One 16-kbps D-channel
- 16 kbps for framing, maintenance, and synchronization

Table 2-1 shows the basic specifications for the 800 CO-BRI module.

Table 2-1.800 CO-BRI Module Specifications

Module	Line/ Trunk Type	Specifications
800 CO-BRI	BRI	Capacity: 8 ports support 16 lines Signaling: BRI Loop range: 3.4 miles

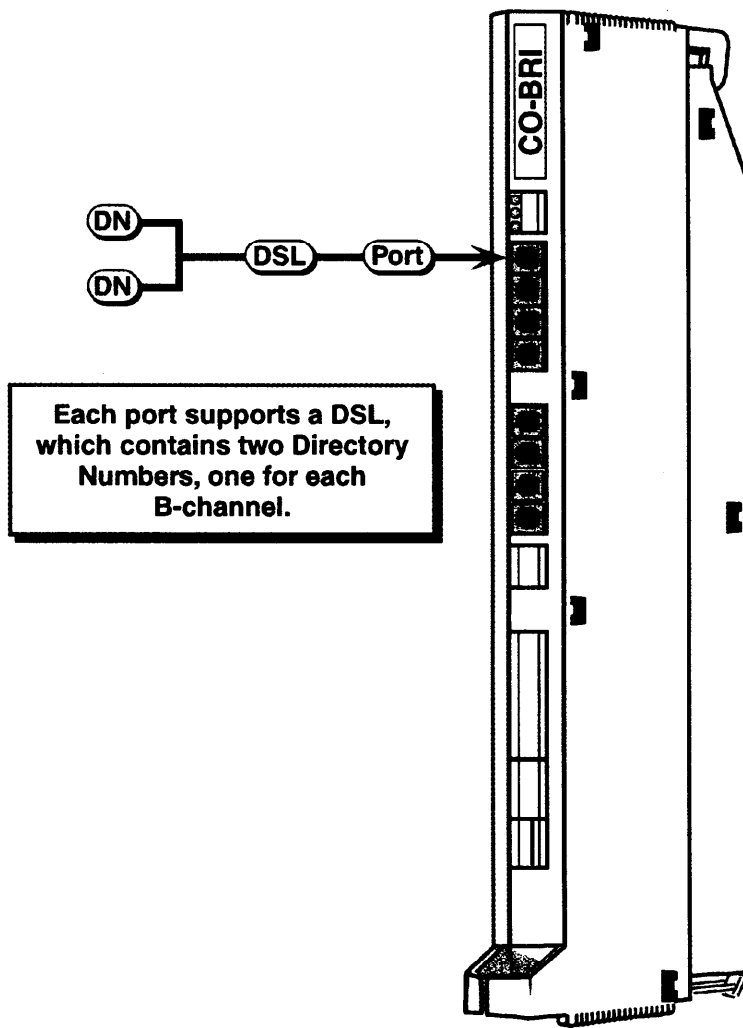

Figure 2-1. 800 CO-BRI Module

Equipment and Operation

Red, green, and yellow LEDs indicate the status of the module (see Table 2-2):

- A lit red LED indicates an active alarm on one or more of the eight active Digital Subscriber Lines (DSLs), or indicates that the module is out of service.
- A lit green LED indicates the module is in a test condition.
- A lit yellow LED indicates an active call on the module.

Table 2-2.800 CO-BRI Module LEDs

Status	LED		
	Red	Green	Yellow
Initialization Mode	On	Off	Off
Standby Mode	On	Off	Off
Test Mode	Off	On	Off
Normal Mode, Off-Hook	Off	Off	On
Normal Mode, On-Hook	Off	Off	Off
Module or Port Alarm	On	Off	Off
Test Mode	Off	On	On

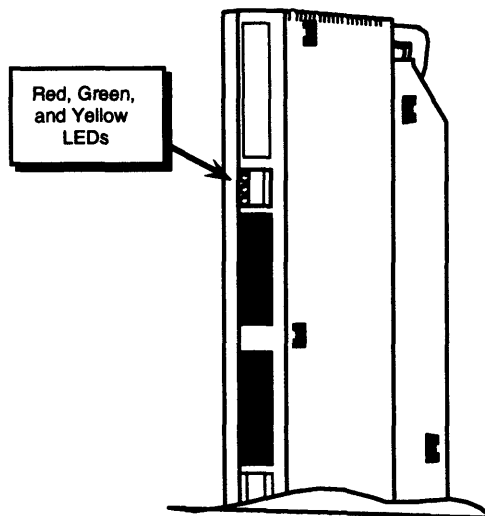

Figure 2-2. LEDs on an 800 CO-BRI Module

Wiring the 800 CO-BRI Module

The wiring running from the network interface to the 800 CO-BRI module is the same as that for other line modules, which is usually a D8W cord. However, this depends upon the network interface used. See the *MERLIN LEGEND Communications System Installation* manual (555-620-1 41) for complete information.

As mentioned, the 800 CO-BRI module is a two-wire interface. This means that the interface operates on two-wire, twisted-pair cables of mixed gauges. The two wires are reversible—they are not polarity sensitive. Table 2-3 shows the pin assignments for an 8-position jack connected to the 800 CO-BRI module.

Table 2-3. Pin Assignments for 8-Position Jack on an 800 CO-BRI Module

Pin Number	Function	Description
1	No connection	Not used
2	No connection	Not used
3	No connection	Not used
4	Signal	Tip or Ring of pair to and from the network interface
5	Signal	Tip or Ring of pair to and from the network interface
6	No connection	Not used
7	No connection	Not used
8	No connection	Not used

Installation of Equipment

As previously discussed, the hardware for a MERLIN LEGEND BRI system consists of an 800 CO-BRI module and a 2.B Feature module. If the entire MERLIN LEGEND BRI system is new, the Feature module is already installed in the Processor module. If the MERLIN LEGEND system is being upgraded to a MERLIN LEGEND BRI system, the old Feature module must be replaced with the 2.B Feature module.

Installing the 800 CO-BRI Module

The installation is similar to installing any line module. Do not leave empty slots between modules in the carrier. The system ignores any modules installed beyond an empty slot.



CAUTION:

To prevent damage from electrostatic discharge (ESD), avoid touching leads, connectors, pins, and other components. Use a properly grounded wrist strap.

Follow these steps to install an 800 CO-BRI module in the control unit. See the *MERLIN LEGEND Communications System Installation* manual (555 -620-1 41) for more information.

1. Review the system planning form to verify the slot placement for the module.



CAUTION:

Remove the protective cover from the module's gold-finger connector before installing the module into the carrier,

2. Lower the module onto the rod on the carrier in the appropriate slot.
3. Swing the module into the slot. Be sure that the connector on the module mates properly with the connector on the carrier, and firmly push the module into the carrier until it locks into place (see Figure 2-3).

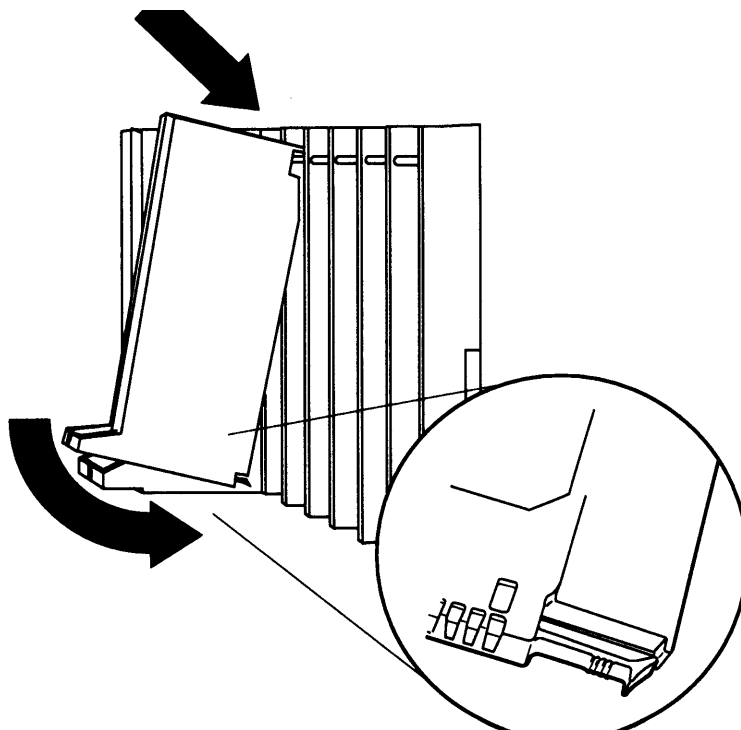

Figure 2-3. Installing the 800 CO-BRI Module

NOTE:

If the module is difficult to install, check it for alignment problems. Inspect the carrier for damage. If no damage is present, the module should snap into place. If the carrier is damaged, it should be replaced. Contact your authorized representative for a replacement carrier.

Upgrading the MERLIN LEGEND System

If you presently have a MERLIN LEGEND system, you need to upgrade your system. Upgrading a MERLIN LEGEND system includes the following tasks:

- Backing up your current system's programming
- Upgrading your hardware
- Upgrading your system's software
- Adding new modules (optional)
- Programming your upgraded system for BRI

Backing Up Your System's Programming

To backup your existing system's programming, you need to run the backup program from the System Programming and Maintenance (SPM) utility. Verify that your backup was successful and that you have all the necessary records to reprogram the system.

For more information on how to back up your MERLIN LEGEND system, refer to the System *Programming and Maintenance Guide* (555-620-1 42).

Upgrading Your Hardware

To upgrade your MERLIN LEGEND system, you need to install the 2.B Feature module.

Installing the 2.B Feature Module

Follow these steps to remove the old Feature module and install the 2.B Feature module. See the MERLIN LEGEND *Communications System Installation Guide* (555-620-1 41) for more information.



CAUTION:

Make sure that you have all the necessary records to reprogram the system before you replace the Feature module. When the Feature module is replaced, all system memory is lost and the system must be reprogrammed or restored.

1. Shut the system power off.
 - a. Turn off the power at the power supply module in the **basic** carrier.
 - b. Turn off the power at the power supply modules in the **expansion** carriers.

- c. Unplug any auxiliary power units. Because the power supply modules are already off, the sequence for removing auxiliary power cords is not important.
2. Remove the Processor module from the carrier.
 - a. Press up on the tab on the bottom of the module.
 - b. Pull the bottom of the module away from the carrier.
 - c. Lift upward to disengage the module from the rod on the top of the carrier.
3. Lay the Processor module on its left side.
4. Grasp the metal rings on the outside of the Feature module and pull up.
5. Align the connectors on the 2.B Feature module with the connectors in the Processor module (see Figure 2-4).
6. Firmly press the 2.B Feature module into the Processor module
7. Insert the Processor module back into the carrier.
8. Turn the power on.
 - a. Plug in any auxiliary power units.
 - b. Set the power switch on the power supply modules in all **expansion** carriers to ON.

The green LED on each expansion carrier's power supply module lights.
 - c. Set the power switch on the **basic** carrier's power supply module to ON.

The green LED on the basic carrier's power supply module lights. The red LED on the Processor module lights for 15 to 45 seconds and then goes off.
9. Perform a system erase.

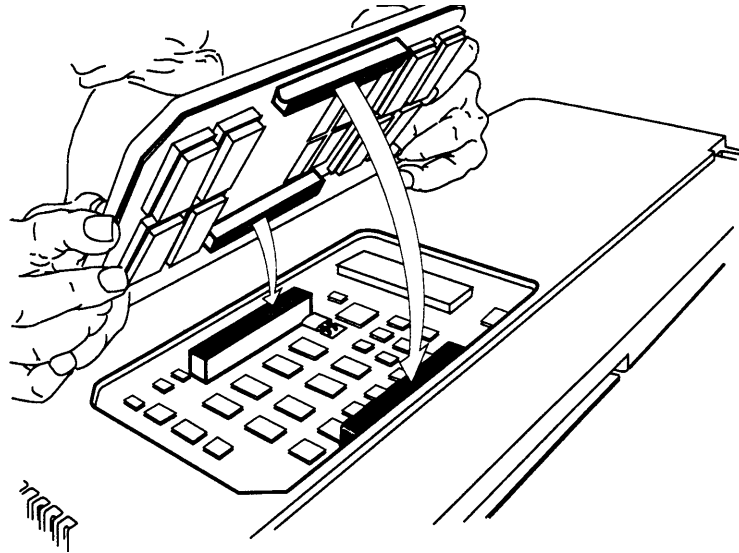

Figure 2-4. Installing the 2.B Feature Module

Upgrading System Software

To upgrade your system software:

- If the system software you backed up is prior to MERLIN LEGEND Release 2.0, you need to upgrade to MERLIN LEGEND 2.B software. Run the Convert feature of the SPM utility, version 3.18, to upgrade Release 1.xx software translations for system programming to Release 2.0. Complete steps 1 and 2.
- If you are installing a new MERLIN LEGEND system, Release 2.0 or later, complete this procedure:
 1. Run the Restore program to “restore” the system software to the 2.B Processor module.
 2. Run the system backup program to save your upgrade.

For more information on the System Programming and Maintenance (SPM) software and performing a system backup, refer to the *System Programming and Maintenance Guide (555-620-1 42)*.

Adding Optional Modules

Once you have performed a complete restoration, depending on your system’s configuration, install your BRI module(s) and any additional modules to your system’s carrier. See the previous section, “installing the 800 CO-BRI Module.”

For more information on installing modules, refer to the *Installation Guide (555-620-1 41)*. For information on assigning lines and trunks, refer to the *System Programming Guide (555-620-111)*.

Programming your Upgraded System

Once you complete installing any additional hardware, perform a complete system backup. You are ready to administer your BRI system.

Refer to Chapter 3 of this guide and the *System Planning Guide (555-620-1 12)* for information on planning and administering your system. Refer to Chapters 4 and 5 of this guide for information on programming your BRI system.

Telephones

The MERLIN LEGEND BRI system supports the same telephones as a MERLIN LEGEND Communications System without BRI with the following exceptions:

- Analog multiline telephones cannot receive Calling Party Number/Billing Number information on their displays.
- A single-line telephone cannot have a BRI Access button, and therefore, cannot initiate a CO Transfer of a call.

NOTE:

It is possible to access a BRI line and dial a 5ESS feature code to access the Local Area Signaling Services (LASS) features. However, the user should not use a single-line telephone because the correct Directory Number needed to activate the LASS features cannot be identified.

- The Secure Telephone Unit III (STU III) 1100 and 1150 series telephones are supported but cannot program a BRI Access button and therefore, cannot use the CO Transfer feature. The STU III 1100M series telephone are fully supported and can program a BRI Access button.

NOTE:

Tip/ring ports and stations cannot have a BRI Access button, and therefore, cannot initiate a CO Transfer of a call.

Adjuncts

The following adjuncts cannot be connected to a port on the 800 CO-BRI module:

- Universal Paging Access Module (UPAM)
- Loudspeaker paging equipment
- Music-On-Hold™ (MOH) software
- Maintenance alarm

Applications

Applications that run on other releases of the MERLIN LEGEND system run on a system with an 800 CO-BRI module. Exceptions are:

- Applications connected to Voice Messaging Interface (VMI) ports cannot access the CO Transfer feature because CO Transfer requires the use of a BRI Access button. However, BRI lines are still terminated at these locations and can be answered. This applies to:
 - Automated Attendant (COBOT)
 - AT&T Attendant (COBOTYX)
 - Integrated Solution AUDIX Voice Power (AVP)
 - MERLIN MAIL Voice Messaging System
- CO-based Octel Voice Messaging Systems are not supported.
- System Programming and Maintenance (SPM) utility-The Convert feature can upgrade all MERLIN LEGEND software prior to Release 2.0 to a MERLIN LEGEND BRI system.
- Release 1.0 of the PassageWay software does not recognize the BRI Access button. Release 2.0 is recommended.

In addition to the standard features offered by other releases of the MERLIN LEGEND Communications Systems, the MERLIN LEGEND BRI system offers the ability to subscribe to several special Basic Rate Interface (BRI) features. Each of the BRI features is described in this chapter. Refer to the *Feature Reference*, (555-620-1 10), for a description of standard MERLIN LEGEND features.

NOTE:

Feature operation may vary in different central offices. Contact the local telephone company for information about feature availability and operation.

For each feature (ordered alphabetically), information is presented under the following sub-headings as applicable:

- **Description** - detailed description of the feature, its functions, and typical applications
- **Feature Use** - instructions on how to use the feature
- **Mode Differences** - functional differences of the feature in the Key or Hybrid/PBX mode of operation
- **Considerations and Constraints** - capacities, constraints, and other information to consider before using or programming the feature
- **Telephone Differences** - the variations in the use of the feature with different telephones
- **Feature Interactions** - describes the differences in operation of standard MERLIN LEGEND system features when the BRI feature is used. If the MERLIN LEGEND feature operates normally, a feature interaction is not listed.

All-Call Privacy/Per-Call Privacy

Description

On outgoing calls, the All-Call Privacy (ACP) feature capability allows or prevents the delivery of the calling party number/billing number (CPN/BN) associated with each BRI line to the destination station. The All-Call Privacy feature should be ordered for each BRI line and specified as either activated or not activated. The Per-Call Privacy (PCP) feature is used to override the All-Call Privacy feature.

NOTE:

For Primary Rate Interface (PRI) users, CPN/BN is known as the station identification (SID) number.

All-Call Privacy Activated

When the All-Call Privacy feature has been activated at subscription time, the CPN/BN for the BRI line is *not* sent to the destination station when the BRI line is used to place an outside call. Using the Per-Call Privacy feature causes the CPN/BN for the BRI line to be sent for the next call only.

All-Call Privacy Not Activated

If the All-Call Privacy feature has not been activated, the CPN/BN for the BRI line *is* sent to the destination station when the BRI line is used to place an outside call. Using the Per-Call Privacy feature prevents the CPN/BN for the BRI line from being sent for the next call only.

Features

Feature Use

All-Call Privacy Activated

When the All-Call Privacy feature is activated, the calling party number/billing number (CPN/BN) for the BRI line is not sent to the destination station when a call is placed. Follow these steps to use Per-Call Privacy to override All-Call Privacy and send the CPN/BN for the BRI line for the next call only:

1. While the handset is on-hook, press the Personal Line button or Pool button associated with the BRI line on which the All-Call Privacy feature is assigned.

The red LED next to the line button lights, indicating that the line button will be used to make the call.

2. Lift the handset or, if the telephone is equipped with a speakerphone, press the Speakerphone button.

The green LED lights.

You hear a dial tone.

3. Dial the feature code assigned by the local telephone company to activate Per-Call Privacy.

You hear the confirmation tone (three-burst tone) followed by a dial tone.

4. Dial the number for your outside call.

The CPN/BN associated with the BRI line used to make the call is sent to the destination station for the current call only.

All-Call Privacy Not Activated

When the All Call Privacy feature is not activated, the CPN/BN for the BRI line is sent to the destination station when a call is placed on the line. Follow these steps to use Per-Call Privacy to override All-Call Privacy and prevent the CPN/BN for the BRI line from being sent for the next call only:

1. While the handset is on-hook, press the Personal Line button or Pool button associated with the BRI line on which the All-Call Privacy feature is assigned.

The red LED next to the line button lights, indicating that the line button will be used to make the call.

2. Lift the handset or, if the telephone is equipped with a speakerphone, press the Speakerphone button.

The green LED lights.

You hear a dial tone.

3. Dial the feature code assigned by the local telephone company to activate Per-Call Privacy.

You hear the confirmation tone (three-burst tone) followed by a dial tone.

4. Dial the number for your outside call.

The CPN/BN associated with the BRI line used to make the call is not sent to the destination station for the current call only.

Considerations and Constraints

Since some BRI lines have the All-Call Privacy feature activated while others have the All-Call Privacy feature not activated, stations should be assigned Personal Line buttons that have the same All-Call Privacy status. This way the user always knows whether using the Per-Call Privacy feature allows or prevents the CPN/BN from being sent to the destination station.

Features

Mode Differences

In the Hybrid/PBX mode, BRI lines with different All-Call Privacy status should not be assigned to the same pool.

Feature Interactions

- Auto Dial** The feature code assigned to Per-Call Privacy by the local telephone company can be programmed on an Outside Auto Dial button.
- Directory** The feature code assigned to Per-Call Privacy by the local telephone company can be programmed as an entry in the Personal or System Directory on an MLX-20L telephone.
- Speed Dial** The feature code assigned to Per-Call Privacy by the local telephone company can be programmed as a System or Personal Speed Dial code.

Automatic Callback

Description

Automatic Callback is one of the Local Area Signaling Services (LASS) features. With the Automatic Callback feature, the user can automatically place a call to the last telephone number from which a call was received on a BRI line, even if the caller's telephone number is not known.

Automatic Callback can be activated on any multiline telephone with a Personal Line button for the BRI line on which the call was received. The telephone from which Automatic Callback is activated does not have to be the telephone used to answer the call.

N OTE:

Depending on the local central office, Automatic Callback may be available under a different name and voice prompts may vary.

Feature Use

Line Button Call Received Is Known

If you know the BRI Personal Line button on which the call was received, follow these steps to activate the Automatic Callback feature:

1. While the handset is on-hook, press the Personal Line button associated with the last BRI line used to receive the call.

The red LED next to the line button lights, indicating that the line button will be used to make the call.

2. Lift the handset or, if the telephone is equipped with a speakerphone, press the Speakerphone button.

The green LED lights.

You hear a dial tone.

3. Dial the feature code assigned by the local telephone company to activate Automatic Callback.

Wait for the confirmation tone (a three-burst tone) to ensure that the feature was activated correctly.

The telephone number from which the last call was received on the BRI line is automatically dialed by the central office.

If the telephone number being called is available, you hear ringback.

If the telephone number being called is busy, the central office "camps" or queues the recall attempt at the called number. When the number becomes available, the central office calls you back on the BRI line used to place the call. All telephones sharing the Personal Line button ring with a priority ring (four-burst ring for MLX telephones and three-burst ring for analog telephones) to indicate the completed call.

Line Button Call Received Is Not Known

If more than one BRI line is assigned as a Personal Line button on the telephone and you do not know which Personal Line button received the last BRI call, follow these steps to activate the Automatic Callback feature:

1. While the handset is on-hook, press the programmed BRI Access button.

The green LED next to the BRI Access button flashes.

If the telephone is an MLX display telephone, the following prompt is shown:

Dial 4 for In, 6 for Out

2. Dial a 4, which represents the letter "I" for incoming call.

The red LED moves to the last Personal Line button used to receive an incoming call on a BRI line.

The green LED next to the BRI Access button goes off.

3. Lift the handset or, if the telephone is equipped with a speakerphone, press the Speakerphone button.

The green LED lights.

You hear a dial tone.

Features

4. Dial the feature code assigned by the local telephone company to activate Automatic Callback.

Wait for the confirmation tone (a three-burst tone) to ensure that the feature was activated correctly.

The telephone number from which the last call was received on the BRI line is automatically dialed by the central office.

If the telephone number being called is available, you hear ringback.

If the telephone number being called is busy, the central office “camps” or queues the recall attempt at the called number. When the number becomes available, the central office calls you back on the BRI line used to place the call. All telephones sharing the Personal Line button ring with a priority ring (four-burst ring for MLX telephones and three-burst ring for analog multiline telephones) to indicate the completed call.

Considerations and Constraints

Automatic Callback should be used for calls received on Personal Line buttons only.

Mode Differences

In the Hybrid/PBX mode, Automatic Callback should not be activated for calls received on any type of System Access button or on a Pool button, because there is no way to identify the last BRI line used to receive a particular call.

Telephone Differences

Automatic Callback should not be used on single-line telephones since a single-line telephone user cannot identify the BRI line on which an incoming call was received.

Features

Feature Interactions

- Auto Dial** The feature code assigned to Automatic Callback by the local telephone company can be programmed on an Outside Auto Dial button.
- Directory** The feature code assigned to Automatic Callback by the local telephone company can be programmed as an entry in the Personal or System Directory on an MLX-20L telephone.
- Speed Dial** The feature code assigned to Automatic Callback by the local telephone company can be programmed as a System or Personal Speed Dial code.

Automatic Recall

Description

Automatic Recall is one of the Local Area Signaling Services (LASS) features. With the Automatic Recall feature, the user can automatically place a call to the last telephone number the user called from a BRI Personal Line button without manually redialing the number.

NOTE:

Depending on the local central office, Automatic Recall may be available under a different name and voice prompts may vary.

Feature Use

Line Button on Which Call Was Placed Is Known

If you know which BRI Personal Line button was used to place the last call, follow these steps to activate the Automatic Recall feature:

1. While the handset is on-hook, press the Personal Line button associated with the last BRI line used to place the call.

The red LED next to the line button lights, indicating that the line button will be used to make the call.

2. Lift the handset or, if the telephone is equipped with a speakerphone, press the Speakerphone button.

The green LED lights.

You hear a dial tone.

3. Dial the feature code assigned by the local telephone company to activate Automatic Recall.

Wait for confirmation tone (a three-burst tone) to ensure that the feature is activated correctly.

The last number dialed on the Personal Line button is automatically dialed by the central office.

If the telephone number being called is available, you hear ringback.

If the telephone number being called is busy, the central office “camps” or queues the recall attempt at the called number. When the number becomes available, the central office calls you back on the BRI line used to place the call. All telephones sharing the Personal Line button ring with a priority ring (four-burst ring for MLX telephones and three-burst ring for analog multiline telephones) to indicate the completed call.

Line Button on Which Call Was Placed Is Not Known

If more than one BRI line is assigned as a Personal Line button on the telephone and you do not know which Personal Line button was used to make the last BRI call, follow these steps to activate the Automatic Recall feature:

1. While the handset is on-hook, press the programmed BRI Access button.

The green LED next to the BRI Access button flashes.

If the telephone is an MLX display telephone, the following prompt is shown:

Dial 4 for In, 6 for Out

2. Dial a 6, which represents the letter “O” for outside.

The red LED moves to the last Personal Line button used to make an outgoing call (excluding calls made on a BRI Access button to initiate a CO Transfer).

The green LED next to the BRI Access button goes off.

3. Lift the handset or, if the telephone is equipped with a speakerphone, press the Speakerphone button.

The green LED lights.

You hear a dial tone.

4. Dial the feature code assigned by the local telephone company to activate Automatic Recall.

Wait for the confirmation tone (a three-burst tone) to ensure that the feature is activated correctly.

The last number dialed on the Personal Line button is automatically dialed by the central office.

If the telephone number being called is available, you hear ringback

Features

If the telephone number being called is busy, the central office “camps” or queues the recall attempt at the called number. When the number becomes available, the central office calls you back on the BRI line used to place the call. All telephones sharing the Personal Line button ring with a priority ring (four-burst ring for MLX telephones and three-burst ring for analog multiline telephones) to indicate the completed call.

Considerations and Constraints

Automatic Recall should be used for calls placed from Personal Line buttons only.

Mode Differences

In the Hybrid/PBX mode, Automatic Recall should not be activated for calls made from any type of System Access button or from a Pool button because there is no way to identify the last BRI line used for a particular call.

Telephone Differences

Automatic Recall should not be used on single-line telephones since a single-line telephone user cannot identify the BRI line on which an incoming call was placed.

Feature Interactions

- | | |
|-------------------|---|
| Auto Dial | The feature code assigned to Automatic Recall by the local telephone company can be programmed on an Outside Auto Dial button. |
| Directory | The feature code assigned to Automatic Recall by the local telephone company can be programmed as an entry in the Personal or System Directory on an MLX-20L telephone. |
| Speed Dial | The feature code assigned to Automatic Recall by the local telephone company can be programmed as a System or Personal Speed Dial code. |

Calling Party Number/Billing Number

Description

The Calling Party Number/Billing Number feature allows an MLX display telephone user to see the caller's calling party number (CPN) or billing number (BN) on the display. The CPN/BN is used by the central office to identify lines. The caller can specify if the CPN/BN should be private.

NOTE:

For Primary Rate Interface (PRI) users, CPN is known as the station identification (SID) number.

On the receiving end, the calling information shown on the display depends on how the MERLIN LEGEND BRI service is configured at the central office:

- Only CPN is displayed, if available
- Only BN is displayed, if available
- CPN is the preference and is displayed, if available; otherwise, BN is displayed, if available
- BN is the preference and is displayed, if available; otherwise, CPN is displayed; if available

NOTE:

Depending on your central office, restrictions may prevent the delivery of either or both of these numbers.

The CPN/BN information is shown only on MLX display telephones, and not on analog multiline display telephones or single-line telephones. However, when a call is received on a BRI line, the analog display telephone shows the label programmed for the BRI line.

When the caller's Calling Party Number information is available from the 5ESS central office, the information is shown on page 1 of the MLX display telephone. The number the caller dialed to reach the MERLIN LEGEND system is shown on page 2.

NOTE:

For calling groups, the information is reversed: the number the caller dialed is shown on page 1 and the CPN information is shown on page 2.

Figure 3-1 shows the information that appears on the different types of MLX display telephones when a call is ringing on a BRI line. On these displays, the BRI line number is 801, the label programmed for the BRI line is "BRI," the Calling Party Number is "505-555-7000," and the number the caller dialed to reach the user is "610-555-1234."

Features

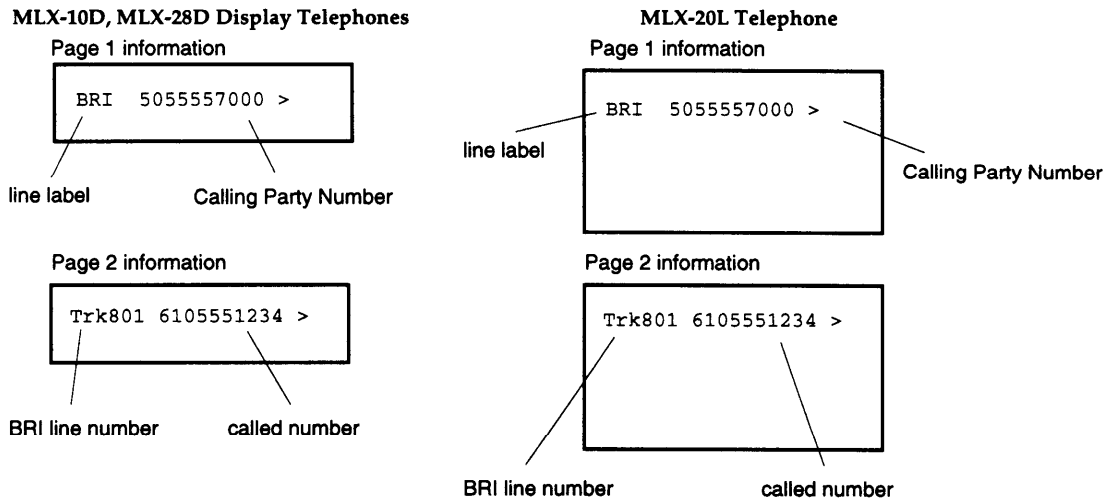

Figure 3-1. MLX Display Telephone Calling Party Number Information

Telephone Differences

The Calling Party Number information is shown only on MLX display telephones, and not on analog multiline display telephones or single-line telephones.

Features

CO Transfer

Description

Similar to the MERLIN LEGEND Trunk-to-Trunk Transfer feature, the Central Office (CO) Transfer feature allows a user to transfer an outside call to an outside destination. For example, a user can connect the caller to a branch location in a distant city or can redirect a misdialed number to the correct telephone number.

To use the CO Transfer feature, the user must select a new programmable button — the BRI Access button. The caller uses the BRI Access button to dial the outside number to complete the transfer of the call. The central office processes the transfer and the lines to the MERLIN LEGEND BRI system are freed immediately for additional call handling. In contrast, the standard MERLIN LEGEND Trunk-to-Trunk Transfer ties up the lines for the duration of the call.

Feature Use

When a call is made or received on a BRI line, you can initiate a CO Transfer on a multiline telephone by following these steps:

NOTE:

The CO-Transfer feature can be programmed to be used for outgoing calls only, incoming calls only or both, depending on programming at the central office. In addition, the CO may impose restrictions to some destinations. Contact the local telephone company for information.

1. While a call is in progress on a BRI line, press the Transfer button.

As in the MERLIN LEGEND Transfer feature, the system puts the BRI call on hold for transfer.

The green LED next to the line button with the held transfer call flutters to indicate that the call is on hold. On other stations that share the line button, the green LED next to the line button with the held transfer is lit to indicate that the line is in use.

The outside party hears Music-on-Hold or ringback, whichever is programmed as the Transfer Audible.

The system also automatically selects a System Access (SA) or Intercom (ICOM) Voice button, or an SA or ICOM Ring button.

Features

2. Press the programmed BRI Access button,

The red and green LEDs next to the BRI Access button go on.

You hear dial tone. The outside caller being transferred hears silence while the call is being connected.

3. Dial the outside telephone number.

NOTE:

Do not use Automatic Route Selection (ARS) or pool dial-out code to dial the outside number even if the system is operating in the Hybrid/PBX mode.

If you receive no answer or a busy signal at the destination telephone number, you can return to the call being held for transfer by pressing the line button associated with the call. This action removes the transfer request and connects you with the original call.

4. To complete the transfer press the MERLIN LEGEND Transfer button, select another line button, or hang up.

Depending on your CO, the party to receive the transferred call must answer the call, or the call must ring at the destination number to complete the transfer, otherwise the call is disconnected.

The LEDs next to both the original BRI line and the BRI Access button go off to indicate that both line buttons are available for use.

Considerations and Constraints

When transferring a call by using the CO Transfer feature, the user should advise the caller that Music-On-Hold or ringback will be heard for a short time and then will stop during the transfer. This prevents the caller from assuming the call is disconnected.

If the user selects any button other than the BRI Access button to initiate the transfer — for example, a System Access (SA) button or Personal Line button, (even with a BRI line assigned) – a MERLIN LEGEND Trunk-to-Trunk Transfer is initiated and both lines used to complete the transfer are in use for the duration of the call.

NOTE:

This feature may operate differently depending on programming at the central office. Contact the local operating telephone company for instructions,

If the BRI caller being transferred hangs up while the CO Transfer is in progress, all transfer conditions are removed. The call to the destination on the BRI Access button is no longer a transfer. The following conditions occur:

Features

- The LEDs next to the line button of the call being transferred goes off to indicate that the call was disconnected. The LEDs next to the BRI Access button and any other shared assignments of the line remain on to indicate that the BRI line is busy with the transfer destination call.
- Incoming calls to the line receive a busy condition unless the Multi-Line Hunt Group (MLHG) feature is assigned. When the MLHG feature is assigned, new incoming calls to the line hunt to the next available line in the group until the call on the BRI Access button is completed.
- The call on the BRI Access button can be put on hold. However, activation of standard features such as Conference or Transfer are blocked for the duration of the call.

If the user selects another line button (for example, to answer a call) before the transfer is complete, the CO Transfer request is removed. The call on hold for transfer remains on hold on the original BRI line button. To reinstate the CO Transfer, the user must press the button next to the held call and begin the transfer procedure from step 1. If the user tries to press the BRI Access button without first returning to the held call, the system ignores the button press and the call remains on hold.

Users with shared appearances of the BRI line cannot bridge onto a call on hold for a CO Transfer. If another user tries to join the call, the attempt is blocked.

Mode Differences

In the Hybrid/PBX mode, do not use an Automatic Route Selection (ARS) or pool dial-out code to dial the destination telephone number on the BRI Access button during a CO Transfer.

Telephone Differences

A BRI Access button cannot be assigned to single-line telephones, and single-line telephone users cannot initiate a CO Transfer,

Features

Feature Interactions

- Allowed Lists** If a restricted user attempts to dial an outside number on a BRI Access button and the number is not on an Allowed List assigned to the telephone, the user hears a reorder tone. The call held for transfer remains on hold, and the user must press the associated line button to return to the call.
- Barge-In** Barge-In cannot be used to join a call on the BRI Access button. While a CO Transfer is in progress, Barge-In cannot be used to join the call on hold for transfer on the BRI line button.
- Calling Restrictions** If a user attempts to dial an outside number on a BRI Access button on an outward-restricted telephone, the user hears a reorder tone. The call held for transfer remains on hold, and the user must press the associated line button to return to the call.
- Conference** A user cannot join the call on hold for transfer, the destination call, or establish a three-way conference as with the standard Trunk-to-Trunk Transfer feature. If the user presses the Conference button while a CO Transfer is in progress, the button press is ignored.
- Coverage** If an incoming BRI call is answered on a Primary, Secondary, or Group Coverage button, the BRI Access button on the recipient's telephone can be used to initiate a CO Transfer of that call.
- Direct-Line Console (DLC)** A DLC system operator can put BRI calls made from a BRI Access button on Automatic Hold. If the DLC system operator puts the call to the destination on Automatic Hold while a CO Transfer is in progress, the system operator cannot return to the held-for-transfer call. The operator should press the BRI Access button and complete the steps for a CO Transfer.
- Directory** Personal and System (MLX-20L telephones only) Directory entries can be used to dial the outside telephone number on a BRI Access button during a CO Transfer. Directory entries including ARS or pool dial-out codes should not be used to dial the destination number.
- Disallowed Lists** If a restricted user attempts to dial an outside number on a BRI Access button and the number is on a Disallowed List assigned to the telephone, the caller hears a reorder tone and the user must press the associated line button to return to the call.

Features

- Hold** BRI calls made from a BRI Access button can be put on hold. If the user puts the call to the destination on hold while a CO Transfer is in progress, the user cannot return to the held-for-transfer call. The user should press the BRI Access button and follow the steps in the Feature Use instructions to initiate the transfer.
- Last Number Dial** The digits of numbers dialed on the BRI Access button during a CO Transfer are stored and can be redialed by using the Last Number Dial feature.
- Park** A call on a BRI Access button cannot be parked on user or operator park zones.
- Pickup** A call on hold at a BRI Access button cannot be picked up by using the Pickup feature, The call on hold for CO Transfer cannot be picked up by using the Pickup feature.
- Queued Call Console (QCC)** The factory-set buttons assigned to a QCC operator position cannot be changed. Therefore, a BRI Access button cannot be assigned to a QCC operator position, and a QCC system operator cannot initiate a CO Transfer.
- The QCC operator can use the Join feature to connect a conference call involving BRI lines. (If the QCC operator drops out of the conference, the standard Trunk-to-Trunk Transfer feature is activated and the two outside BRI lines are used for the duration of the call.) Refer to the Join feature in the Feature Reference, (555-620-110).
- Recall** The Recall feature cannot be used on calls from a BRI line button or from a BRI Access button, While the user is on a call on either type of line button, pressing of the Recall button is ignored.
- Save Number Dial** The digits of numbers dialed on the BRI Access button during a CO Transfer can be stored and can be redialed by using the Save Number Dial feature.

Features

Station Message Detail Recording (SMDR)

A call transferred by using the BRI feature generates only one SMDR record. When a user selects a BRI Access button to initiate a CO Transfer, an "X" appears after the dialed digits (that is, in the far-end disconnect field) to identify the call as CO Transfer based. The call is tagged as a CO Transfer call even if the transfer is canceled and the user returns to the held-for-transfer call.

The digits for the transfer destination are displayed in the Dialed Digits field.

Refer to the *Feature Reference*, (555-620-110), for more detailed information on SMDR classes of calls.

Transfer

The standard Transfer feature can be used to transfer calls on BRI lines to an inside extension number or to transfer an inside call to an outside number using a BRI line button.

If the user selects a button other than a BRI Access button (for example, a System Access or Personal Line button) to transfer a BRI call to an outside number, the MERLIN LEGEND Trunk-to-Trunk Transfer feature is activated.

Customer Originated Trace

Description

Customer Originated Trace is one of the Local Area Signaling Services (LASS) features. With the Customer Originated Trace feature, the user can call the central office to obtain the telephone number from which the incoming call was received on the BRI line without placing a call to the telephone number.

Customer Originated Trace can be activated on any multiline telephone with a Personal Line button for the BRI line on which the call was received. The telephone from which Customer Originated Trace is activated does not have to be the telephone used to answer the call.

The user should select the Personal Line button representing the BRI line as soon as possible after receiving the call. If another call is received on the BRI line assigned to the Personal Line button, the original call can no longer be traced.

NOTE:

The requirements on the release of the telephone number vary depending on locality. In some cases, you are required to obtain the information through the local law enforcement agency. Contact the local telephone company for information on local requirements and on feature use.

Considerations and Constraints

Trace information cannot be requested for a call in progress on a BRI line. The user must hang up before activating the Customer Originated Trace feature.

Customer Originated Trace should be used for calls received on Personal Line buttons only.

Mode Differences

In the Hybrid/PBX mode, Customer Originated Trace should not be activated for calls received on any type of System Access button or on a Pool button because there is no way to identify the last BRI line used to receive a particular call.

Features

Telephone Differences

Customer Originated Trace should not be used on single-line telephones since a single-line telephone user cannot identify the BRI line on which an incoming call was received.

Feature Interactions

- | | |
|-------------------|--|
| Auto Dial | The feature code assigned to Customer Originated Trace by the local telephone company can be programmed as an Outside Auto Dial button. |
| Directory | The feature code assigned to Customer Originated Trace by the local telephone company can be programmed as an entry in the Personal or System Directory on an MLX-20L telephone. |
| Speed Dial | The feature code assigned to Customer Originated Trace by the local telephone company can be programmed as a System or Personal Speed Dial code. |

Multi-Level Precedence and Preemption (MLPP)

Description

The Multi-Level Precedence and Preemption (MLPP) feature is available primarily for Federal Government configurations. MLPP allows a user to place calls of various priorities that alert with a distinctive ring and may preempt lower priority calls.

There are five levels of priority calling defined by the MLPP feature. The levels are indicated by a precedence code, which consists of the digits "0" through "4." The digit "0" indicates the "flash override"- the highest priority — and "4" indicates "routine"- the lowest priority or no priority. Levels are set by the private branch exchange.

Feature Use

Follow these steps to activate the MLPP feature:

1. While the handset is on-hook, press the Personal Line button or Pool button associated with the BRI line on which the MLPP feature is assigned.

The red LED next to the line button lights, indicating that the line button will be used to make the call.

2. Lift the handset or, if the telephone is equipped with a speakerphone, press the Speakerphone button.

The green LED lights.

You hear a dial tone.

3. Dial the feature code assigned by the local telephone company to activate MLPP. The feature code includes the precedence code ("0" through "4") that indicates the priority of the call.

You hear the confirmation tone (a three-burst tone) and followed by a dial tone.

Features

4. Dial the number of your outside call.

If the station being called is idle, an MLPP priority call alerts with a distinctive MLPP ringing pattern. On the MERLIN LEGEND system, you hear the priority ringing pattern (a four-burst ring on an MLX telephone and a three-burst ring on an analog multiline and single-line telephone) instead of the normal ringing pattern associated with an outside call (a two-burst ring on all telephone types).

If the station being called is on a call and the call is being preempted by a higher priority call, the person at the other end of the call hears an announcement advising that "your call is being preempted." The call is cleared as if the person at the other end hung up. The station is then connected to the priority caller.

If an MLPP priority call is not answered within a certain amount of time, the call can be re-routed by the central office.

Considerations and Constraints

Stations should be assigned Personal Line buttons that have the same MLPP privileges.

BRI lines with the MLPP feature assigned should not be mixed in the 5ESS Multi-Line Hunt Group (MLHG) with BRI lines without the MLPP feature.

Mode Differences

In the Hybrid/PBX mode, BRI lines with different MLPP privileges should not be assigned to the same pool.

Feature Interactions

- | | |
|-------------------|---|
| Auto Dial | The feature code assigned to MLPP by the local telephone company can be programmed to an Outside Auto Dial button. |
| Directory | The feature code assigned to MLPP by the local telephone company can be programmed as an entry in the Personal or System Directory on an MLX-20L telephone. |
| Speed Dial | The feature code assigned to MLPP by the local telephone company can be programmed as a System or Personal Speed Dial code. |

Planning

4

Planning ensures proper use of the Basic Rate Interface (BRI) features offered by the MERLIN LEGEND Communications System. This chapter contains guidelines for the following:

- Placing the modules
- Connecting the BRI lines to the system
- Selecting options for those lines
- Assigning lines to the stations

Only those options that involve MERLIN LEGEND BRI lines are contained in this guide.

Planning Overview

Planning for a MERLIN LEGEND BRI communications system is the same as for other releases of the MERLIN LEGEND system, with some exceptions. Only those differences and planning form instructions for BRI lines connected to the 800 CO-BRI module are contained in this chapter.

Refer to the *System P/arming* guide (555-620-112) to make the appropriate decisions and planning form entries for other types of facilities (loop start, ground start, etc.) connected to the system.

On a new system, all lines connected to the system should be planned simultaneously to save time.

System Planning Forms

Whether planning options for a new system or modifying an existing system, record decisions on the appropriate planning form shown in Table 4-1. Work on copies of master forms from the *System Planning Guide* (555-620-112). Appendix A of this guide includes forms for planning BRI features. Planning forms for BRI are also available in the *Provisioning Guide and Planning Forms* (555-601-112).

When planning is completed, see Chapter 5, "System Programming," for instructions on programming the BRI options.

Planning

Table 4-1. System Planning Forms Needed for BRI Planning

To Plan	Use These Forms	To Use as Reference	To Make Entries
Line and station capacity	1, <i>System Planning—Capacity</i>		✓
Module placement	1, <i>System Planning—Control Unit Diagram</i>	✓	✓
Mode of operation	1, <i>System Planning—System Operating Conditions</i>	✓	✓
Equipment and station jack assignment	2a, <i>System Numbering—Station Jacks</i>	✓	
Trunk jack types	2c, <i>System Numbering—Trunk Jacks</i>	✓	✓
Jacks for outside lines	2c, <i>System Numbering—Trunk Jacks</i>	✓	✓
Remote Access	2c, <i>System Numbering—Trunk Jacks</i>	✓	
	3a, <i>Incoming Trunks—Remote Access</i>		✓
Pools	2c, <i>System Numbering—Trunk Jacks</i>	✓	
BRI facility options	3e, <i>Outside Lines—BRI Options</i> (Appendix A, this guide)		✓
Line assignments and Telephone feature: Pool Dial-Out Code	4b, <i>Analog Multiline Telephone</i>		✓
	4d, <i>MLX Telephone</i>		✓
	4e, <i>MFM Adjunct—MLX Telephone</i>		✓
	4f, <i>Tip/Ring Equipment</i>		✓
	5a, <i>Direct-Line Console (DLC)—Analog</i>		✓
	5b, <i>Direct-Line Console (DLC)—Digital</i>		✓
	5c, <i>MFM Adjunct—DLC</i>		✓
Copy an extension's programmed buttons to one or more stations	4a, <i>Extension Copy—Analog Multiline Telephone Template</i>		✓
	4c, <i>Extension Copy—MLX Telephone Template</i>		✓
Group Calling	6e, <i>Group Calling</i>		✓
Labeling	2c, <i>System Numbering—Trunk Jacks</i>		✓

Control Unit Planning

Line Capacity

The 800 CO-BRI module contains eight BRI ports. Each port supports two MERLIN LEGEND BRI lines for a total of 16 lines per module. This allows connection of 16 BRI lines from a 5ESS Generic 8 Custom central office at the local telephone company.

A maximum of five 800 CO-BRI modules can be connected to the system (not to exceed the system capacity of 80 BRI lines).

Planning Form Instructions — System Form 1, System Planning

1. In the table under “Trunks” in the “Capacity” section, find a module type not being used, cross through the module type name, and write “800 CO-BRI.”
2. Change the information in “Trunks Supported by Module” to 16.
3. Multiply the number of CO-BRI modules by 16, and write the results in the “Total Lines by Module Type” column.

Module Placement

The 800 CO-BRI modules should be grouped together whenever possible to save time in system programming.



CAUTION:

Because of limitations with the 391A, 391A 1, and 391A2 power supplies, the number of 800 CO-BRI modules plus 100D modules in a carrier cannot exceed three per carrier.

Planning Form Instructions — System Form 1, System Planning

1. On the “Control Unit Diagram, write “800 CO-BRI” on the slanted lines at the top of each slot containing an 800 CO-BRI module.
2. Indicate the type of jack on each 800 CO-BRI module by writing “T” (Trunk) and the associated logical ID for each of the BRI lines connected to the 800 CO-BRI module. Keep in mind that each 800 CO-BRI module is assigned 16 logical IDs even though the module has only eight physical jacks.

Mode of Operation

Key Mode

The Key mode makes the most efficient use of the Local Area Signaling Services (LASS) features available on BRI lines since users are directly connected with the outside BRI line via a Personal Line button.

In the Key mode, to use the CO Transfer feature to transfer a call and allow the central office to complete the transfer, the user must select a new programmable button-the BRI Access button. The user selects the BRI Access button, dials the outside number, and completes the transfer. The central office processes the transfer and the BRI line to the MERLIN LEGEND system is freed immediately for additional call handling. If another type of line button is selected (for example, Personal Line), the MERLIN LEGEND Trunk-to-Trunk Transfer feature is invoked, which ties up both the incoming and outgoing lines for the duration of the call.

For other types of outside lines (for example, loop start or ground start), the first eight outside lines are automatically assigned to all telephones at system start-up. However, BRI lines are not assigned to line buttons automatically and must be assigned during system programming.

Hybrid/PBX Mode

In the Hybrid/PBX mode, the BRI lines can be grouped together in pools for shared use. In addition, BRI lines can be assigned to Personal Line buttons on multiline telephones for users who require a personal line.

As with a Key system, to use the CO Transfer feature, the user selects the BRI Access button, dials the destination number, and completes the transfer. The central office processes the transfer and the BRI line to the system is freed immediately for additional call handling. When dialing the destination number, the user does not use an Automatic Route Selection (ARS) or Pool Dial-Out code to dial the number. In addition, if other types of lines are selected (for example, Personal Line or Pool buttons), the MERLIN LEGEND Trunk-to-Trunk feature is invoked, which ties up both the incoming and outgoing lines for the duration of the call.

Line Connections

Line Jack Types

The line jack type is determined by the type of module. The line jack type for the 800 CO-BRI module is BRI. Auxiliary equipment such as Music-On-Hold, loudspeaker paging, and maintenance alarms cannot be connected to BRI line jacks.

Planning Form Instructions — System Form 2c, System Numbering-Trunk Jacks

For each 800 CO-BRI module, write “BRI” under “Jack Type.”

Jacks for Outside Lines

Each of the 16 BRI lines on the 800 CO-BRI module is associated with a logical ID and a line number in the System Numbering Plan. For example, if the 800 CO-BRI module is placed in slot 01 of the control unit, the 16 BRI lines are automatically assigned logical IDs 1 through 16 and dial plan numbers 801 through 816. Figure 1-4 shows the directory and dial plan mapping,

The logical ID is shown under the “Log. ID” column and the line numbers are shown under the “Trunk No.” column.

Planning Form Instructions —System Form 2c, System Numbering-Trunk Jacks

1. Using the completed “Control Unit Diagram” from System Form 1, write “800 CO-BRI” and its slot number in the “Module Type and Slot No.” column and draw a line across the column to indicate the 16 logical IDs and trunk jacks that correspond to that module.
2. Write “BRI” under “Jack Type.”
3. Using the BRI line information from the local telephone company, write the type of line in the “Incoming Trunk Type” column:
 - Write “Main No. ” to indicate the main telephone number.
 - Write “Personal Line” to indicate a BRI line used as a personal line.
 - Write “unequipped” to indicate a trunk jack not used at this time, and enter the information when the BRI line is ordered.

Planning

4. Under the "Telephone Number or Equipment" column, write the assigned Directory Number from the local telephone company for each BRI line on the line corresponding with the logical ID for its jack. If the telephone number is not known, leave the column blank and enter the information later.
5. In the "Label" column, write the label for each BRI line. The labels can contain up to seven characters, including capital letters, numbers, ampersand (&), dash (—), space, colon (:), asterisk (*) and pound sign (#). The factory assigned label is "Outside."

Refer to "Selecting Trunks Options" in the System *P/arming Guide (555-620-112)* for the remaining entries on the form.

Jacks for Auxiliary Equipment

Auxiliary equipment cannot be connected to a BRI line jack.

Line Options

QCC Operator to Receive Calls--Hybrid/PBX Mode Only

Assign this option to BRI lines under the following conditions:

- System operates in the Hybrid/PBX mode.
- System includes one or more queued call consoles (QCCs).
- Incoming calls on BRI lines ring into the QCC queue.

Assigning the QCC operator to receive calls on each BRI line determines, first, if incoming calls on each BRI line ring into the QCC queue and, second, which QCC operator position answers the calls.

BRI lines can be programmed to ring into the QCC queue just like other line types. Planning form instructions for the system with the MERLIN LEGEND BRI system are the same as for other releases of the MERLIN LEGEND system.

Planning

QCC Queue Priority-Hybrid/PBX Mode Only

If one or more BRI lines are assigned to ring into the QCC queue, refer to the System Planning Guide (555-620-112) for instructions.

Remote Access

BRI lines can be programmed for Remote Access. Planning for this option for the MERLIN LEGEND BRI system is the same as for other releases of the MERLIN LEGEND system.

Pools

When the system is set up, BRI lines are not automatically assigned to any pool at system start-up.

BRI lines should not be mixed in Pools with other types of lines such as loop-start, ground-start, or PRI. In addition, all BRI lines assigned to one pool should be configured the same way. That is, the User Service Order Profile (USOP) configured at subscription time should be the same. This guarantees that no matter which line the system selects for an outgoing call, the same features are available to the users.

BRI Line Options

To ensure proper operation of the BRI line features, the following options are set during system programming:

- Service Profile Identifier (SPID) for each BRI line
- Clock Synchronization for each BRI module
- Timers for each BRI module

A brief overview for ordering BRI features from your local telephone company follows. See Appendix B for more information.

Service Profile Identifier (SPID)

The SPID is a unique identifier that associates the BRI lines connected to the system with a particular User Service Order Profile (USOP). The USOP is configured on the 5ESS central office at subscription time. The USOP contains information necessary for the central office to provide service to each station connected to the system and consists of the following parameters:

- Each BRI line is assigned a Directory Number. Each Directory Number has two call appearances. The first call appearance is used to process both incoming and outgoing calls, and the second call appearance is used to originate outgoing calls only while performing a CO Transfer.
- The type of terminal supported is specified. The terminal type for the MERLIN LEGEND BRI system is type D.
- The USOP also indicates if the features provided for each BRI line include the following features:
 - Local Area Signaling Services (LASS) features:
 - Automatic Callback (AC)
 - Automatic Recall (AR)
 - Customer Originated Trace (COT)
 - All-Call Privacy (ACP)/Per-Call Privacy (PCP)
 - Calling Party Number/Billing Number (CPN/BN)
 - Multi-Line Hunt Group (MLHG)
 - Multi-Level Precedence and Preemption (MLPP)

The local telephone company provides the SPID for each DSL ordered. The SPID consists of a string of digits 0 through 9 not more than 10 digits in length.

Planning Form Instructions

Transfer the following information from System Form 2c, *System Numbering-Trunk Jacks* to System Form 3e, *Outside Lines-BRI-Options*:

1. Write the logical ID in the "Logical ID" column.
2. Write the line number in the "Line Number" column.

Refer to the information provided by the local telephone company to enter the following information:

3. Write the Directory Number for each BRI line in the "Directory Number" column.
4. Write the SPID assigned to each BRI line in the "Service Profile Identifier" column.

5. Indicate the features available on each BRI line:
 - a. To indicate All-Call Privacy/Per-Call Privacy, put a check mark in the "ACP" column.
 - b. To indicate Calling Party Number/Billing Number, put a check mark in the "CPN" column.
 - c. To indicate Automatic Callback, put a check mark in the "AC" column.
 - d. To indicate Automatic Recall, put a check mark in the "AR" column.
 - e. To indicate Customer Originated Trace, put a check mark in the "COT" column.
 - f. To indicate the Multi-Line Hunt Group feature, put a check mark in the "MLHG" column.
 - g. To indicate Multi-Level Precedence and Preemption, put a check mark in the "MLPP" column.

Clock Synchronization

If the system includes both 800 CO-BRI and 100D modules, clock synchronization planning should be completed at the same time. There is only one primary/secondary/tertiary clock for both 800 CO-BRI modules and 100D modules, with the same system programming screens used for both types.

Plan your clock source administration to minimize the need for clock switching, which is known to cause noise on active calls.

The primary, secondary and tertiary clock sources, all three of which should be administered if possible, should be set in the following order:

- a. The loop clock source on any 100D module connected to the CO.
- b. The loop clock sources on connected BRI DSLs on the same module, with preference given to ones that are used to consistently transmit data (as opposed to voice).
- c. The loop clock source on any 100D module in T1 mode operating in a tie-trunk configuration.
- d. The local clock source on any 100D module.

Extra BRI DSLs which are not connected should never be administered as clock sources.

Planning Form Instructions

Refer to System Form 1, System *Planning*, "Control Unit Diagram." Complete the following information on System Form 3e, *Outside Lines-BRI-Options*, page 2:

1. To keep the factory setting (the first slot and port found in the system provides synchronization for the system) or if assigning a different module to provide primary clock synchronization:
 - Enter the slot and/or DSL number (BRI only) under "Primary Clock Synchronization."
 - Under the "Source" subheading, check "Loop" to indicate that the system uses the clock of the far-end connection (factory setting) or "Local" to indicate the clock is free-running (100D modules only).

NOTE:

The only option for a 800 CO-BRI module is loop.

2. If assigning secondary or tertiary backup synchronization:
 - Enter the slot and DSL number (BRI only) under "Secondary Clock Synchronization" and/or "Tertiary Clock Synchronization."
 - Under the "Source" subheading in each column, check "Loop" to indicate that the system uses the clock of the far-end connection (factory setting) or "Local" to indicate the clock is free-running (100D modules only).

NOTE:

The only option for a 800 CO-BRI module is loop.

Timers

Timers ensure that the system takes the appropriate corrective action when no response is received from the network before the factory-set or programmed settings have expired.



CAUTION:

Since incorrect settings can hinder the operation of BRI facilities, consult with an A T&T representative or authorized dealer before making changes. The factory-set thresholds are standard settings and should rarely be changed.

The timers, descriptions, factory settings, and allowable thresholds are shown in Table 4-2.

Planning Form Instructions

On System Form 3e, *Outside Line-BRI-Options*, under the “Timers and Counters” heading on page 2:

For each timer:

- To keep the factory setting, check the first box under the timer name.
- To change the factory setting, check the second box under the timer name and write the new threshold in the space provided.

Table 4-2. Timers

Name	Description	Factory Setting	Allowable Threshold
T200	The minimum time which Layer 2 must wait for an acknowledgment of an information frame before initiating retransmission procedures.	1,000 ms	1,000-2,500 ms in increments of 500 ms
T203	The maximum time for which the Layer 2 link can remain inactive.	33,000 ms	10,000-33,000 ms in increments of 500 ms
T303	The amount of time the system waits for the CO to respond when the system sends a SETUP message to initiate an outgoing call.	2,500 ms	1,000–4,000 ms in increments of 500 ms
T305	The amount of time the system waits for the CO to respond when the system initiates a Disconnect message for call clearing.	4 seconds	4-30 seconds in increments of 1 second
T308	The amount of time the system waits for the CO to respond when the system sends a RELease message for call clearing.	4 seconds	2–10 seconds in increments of 1 second

Assigning Telephone Buttons

Assigning the kinds of buttons for telephones and direct-line consoles (DLCs) for a MERLIN LEGEND BRI system is the same as for other releases of the MERLIN LEGEND system.

In addition to the other kinds of buttons (such as System Access or ICOM, Personal Line, Pool, and Loudspeaker Page), the BRI Access button used for the CO Transfer and LASS features can be programmed on a MERLIN LEGEND BRI system in either the Key or Hybrid/PBX mode:

In addition to the considerations listed in the *System Planning* guide, consider these BRI-specific considerations when selecting the types of buttons to assign to the telephone:

- In both the Key and Hybrid/PBX modes, BRI lines are not automatically assigned to telephones or to DLCs.
- In the Hybrid/PBX mode, assign a Pool button for a pool containing BRI lines that are used frequently. Also consider assigning a Pool button if Automatic Route Selection (ARS) is not planned and the system includes only one or two pools to allow the user to select the pool without dialing a code.
- Any BRI line can be assigned as a Personal Line as long as it is not included in a pool.
- In either the Key or Hybrid/PBX mode, a BRI Access button can be assigned on buttons 1 through 10, the same as with all types of System Access buttons.
- Only one BRI Access button can be programmed per station.
- A BRI Access button cannot be programmed on a tip/ring station (such as a single-line telephone or answering machine).

Planning

Planning Form Instructions

Complete the "Button Diagram" section of each copy of the following forms:

System Form 4b, *Analog Multiline Telephone*
System Form 4d, *MLX Telephone*
System Form 4e, *MFM Adjunct-MLX Telephone*
System Form 4f, *Tip/Ring Equipment*
System Form 5a, *Direct-Line Console (DLC)-Analog*
System Form 5b, *Direct-Line Console (DLC)-Digits/*
System Form 5c, *MFM Adjunct-DLC*

If assigning BRI Access buttons (Key or Hybrid/PBX mode), write "BRI Access" on the appropriate buttons (1 through 10):

NOTE:

A BRI Access button cannot be assigned to a QCC. Therefore, no entries are required on System Form 5d, *Queued Cal/Console (QCC)*.

Features

Assigning telephone, operator, group-assigned, and system features for a MERLIN LEGEND BRI system is the same as for other releases of the MERLIN LEGEND system. Refer to the *System Planning* guide (#555-620-112) for complete planning instructions.

System Programming

5

This chapter contains the instructions to program a MERLIN LEGEND Basic Rate interface (BRI) system for BRI lines. Programming is done by using either an MLX-20L telephone console or a personal computer (PC) with System Programming and Maintenance (SPM) software.

The chapter also covers the programming of a BRI Access button.

Basic Programming Considerations

Following are various items to consider when programming a MERLIN LEGEND BRI system.

- Up to 16 lines per 800 CO-BRI module can be assigned to Personal lines, pools, and calling groups. The default line label for these lines is "OUTSIDE."
- A BRI line cannot be programmed as a paging, Music On Hold (MOH), or maintenance alarm port.
- BRI line appearances can be copied from station to station, but no special BRI options (for example, Service Profile Identifier) are copied.
- The BRI Access button is programmed through Centralized Telephone Programming.
- An 800 CO-BRI module and all BRI programming options can be programmed in surrogate mode. *Surrogate mode* is the programming of settings on a system that has no line/trunk and station modules. These programmed settings are then saved to be used on a complete system, one with line/trunk and station modules.

See the *System Programming Guide* (555-620-111), for a complete description of surrogate mode programming.

Service Profile Identifier

A Service Profile Identifier (SPID) is a unique identifier that associates a Basic Rate Interface (BRI) line on the MERLIN LEGEND system with a particular User Service Order Profile (USOP). The USOP contains the information needed by the central office (CO) to provide BRI service to the line. Each SPID is provided by the CO at subscription time. The SPID is a string of digits (0-9) that cannot exceed 10 digits in length and can have some or all of a user's Directory Number as a subset.

Follow this procedure to program a SPID for every BRI line in the MERLIN LEGEND system. If a SPID is not programmed for a line, the system considers that BRI line inactive.

Entering Programming

Console: Press **Menu** → **Sys** **Program** → **Exit**
PC/SPM: Type **SPM** → Press any key → **F1** → **F5**

Exiting Without Changes

To exit from any screen without making changes, select **Exit** on the console or press **F5** on the PC before saving your entry or menu selection.

Summary Service Profile Identifier

Programmable by	System technician; system manager
Mode	Key, Hybrid/PBX
Idle Condition	Required
Planning Form	System Form 3e, Outside Lines-BRI Options
Factory Setting	None
Valid Entries	Maximum of 10 digits in length, using digits 0 through 9
Inspect	No
Copy Option	No
Console Procedure	Lines Trunks → More → BRI → ServProfId → Dial line no. → Enter → Dial SPID → Enter → Exit → Exit
PC Procedure	F4 → PgUp → F7 → F1 → Type line no. → F Type SPID → F10 → F5 → F5

System Programming

Procedure: Service Profile Identifier

Step	Display/Instructions	On the console	On the PC
1	<pre>System Programming: > Make a selection System Extensions SysReNUMBER Opt ions Operator Tables LinesTrunks AuxEquip Exit NightSrvce</pre> <p>Select the LinesTrunks menu.</p>	Select LinesTrunks. Press F4 .	
2	<pre>Lines and Trunks: > Make a selection LS/GS/DSL PRI TIE Lines copy TT/LS Disc RemoteAccss DID Pools Exit Toll Type</pre> <p>Move to second page of the Lines and Trunks menu.</p>	Press More .	Press PgUp .
3	<pre>Lines and Trunks: > Make a selection HoldDiscnct ClockSync PrncipalUsr BRI QCC Prior QCC Oper Exit</pre> <p>Select BRI.</p>	Select BRI.	Press F7 .
4	<pre>BRI Lines: Make a selection ServProfId Timers Exit</pre> <p>Select ServProfId.</p>	Select ServProfId.	Press F1 .

System Programming

Step	Display/Instructions	On the console	On the PC
5	<pre>Service Profile Id: Enter line number xxx Backspace Exit Enter</pre> <p>Enter the line number.</p>	Dial the line number (for example, 801) and select Enter	Type the line number (for example, 801) and press F10 .
6	<pre>Line xxxx: Enter service profile id xxxxxxxxxx Backspace Next Exit Enter</pre> <p>Enter the SPID for the line (up to 10 digits)</p>	Dial the SPID for the line. Select Next to enter the SPID for the next BRI line.	Type the SPID for the line. Press F9 to type the SPID for the next BRI line.
7	Save your entry.	Select Enter.	Press F10 .
8	To return to System Programming menu	Select Exit two times.	Press F5 two times.

Clock Synchronization

The time-division multiplex (TDM) clock source in the MERLIN LEGEND system provides the timing needed to synchronize the flow of digital transmission between the central office (CO) and the system. Any 100D module or any port on an 800 CO-BRI module can be the TDM clock source. On an 800 CO-BRI module the clock source is loop source (taken from the 5ESS CO). The 800 CO-BRI module can be the primary, secondary, or tertiary clock source. In general, the primary clock should be the most reliable clock source available.

NOTE:

Both 100D modules and 800 CO-BRI modules can be programmed as primary, secondary, and tertiary clock sources, but not simultaneously. For example, if a 100D module is programmed to be the secondary clock source, an 800 CO-BRI module cannot be programmed as the secondary clock source.

The actual point on the 800 CO-BRI module for the loop clock source is one of the ports (the Digital Subscriber Line port).

The following information must be programmed to assign the clock source on the 800 CO-BRI module:

- The slot numbers of the 800 CO-BRI modules that serve as the primary, secondary, and tertiary clocks
- The number of the port used as the source

When the primary clock is programmed, it automatically is activated to serve as the TDM clock reference for the system. Upon a "system erase," the first 100D module or 800 CO-BRI module port found in the control unit from a sequential search becomes the primary loop clock source. Upon a "system restart," the programmed primary clock acts as the TDM clock reference for the system.

Follow these procedures to program the 800 CO-BRI module to be a TDM clock source for the MERLIN LEGEND system.

NOTE:

If possible, to minimize maintenance errors, all three clock sources should be administered following the guidelines in Chapter 4.

Entering Programming

Console: Select **Menu** → **Sys Program** → **Exit**
PC/SPM: Type **SPM** → Select any key → **F1** → **F5**

Exiting Without Changes

To exit from any screen without making changes, select **Exit** on the console or Press **F5** on the PC before saving your entry or menu selection.







System Programming

Summary: Clock Synchronization

Programming	System technician; system manager
Mode	Key, Hybrid/PBX
Idle Condition	Not required
Planning Form	System Form 3e, Outside Lines-BRI Options
Factory Setting	The first 100D module or 800 CO-BRI port found sequentially in the control unit is the default primary loop clock.
Valid Entries	Primary, Secondary, Tertiary
Inspect	No
Copy Option	No
Console Procedure	LinesTrunks → More → ClockSync → Select type of clock source → Dial slot no. → Enter → Dial port no. → Enter → Exit → Exit
PC Procedure	F4 → PgUp → F6 → Select type of clock source → Type slot no. → F10 → Type port no. → F10 → F5 → F5

System Programming

Procedure: Clock Synchronization

Step	Display/Instructions	On the console	On the PC
1	<pre>System Programming: > Make a selection System Extensions SysReNUMBER Options Operator Tables LinesTrunks AuxEquip Exit NightSrvce</pre> <p>Select the LinesTrunks menu.</p>	Select LinesTrunks.	Select 
2	<pre>Lines and Trunks: > Make a selection LS/GS/DSL PRI TIE Lines copy TT/LS Disc RemoteAccss DID Pools Exit Toll Type</pre> <p>Move to the second page Lines and Trunks menu.</p>	Select More .	Select PgUp .
3	<pre>Lines and Trunks: > Make a selection HoldDiscnct ClockSync PrncipalUsr BRI QCC Prior QCC Oper Exit</pre> <p>Select Clock Sync.</p>	Select clock smc.	Select 
4	<pre>Clock Synchronization: Make a selection Primary Secondary Tertiary Exit</pre> <p>Select the type of clock source (in this case, Primary).</p>	Select the type of clock source (in this case, Primary).	Select the function Key ( ,  , or ) for the type of clock source (in this case, ).

System Programming

Step	Display/Instructions	On the console	On the PC
5	<pre>Primary System Clock: Enter slot number (1-17) x x Delete Backspace Exit Enter</pre>		
	Enter the slot number of the 800 CO-BRI or 100D module. Select Enter,	Dial the slot number of the 800 CO-BRI module.	Type the slot number of the 800 CO-BRI module.
6	Save your entry.	Select Enter.	Select F10
7	<pre>Primary ClkSource Slotxx Select one Loop Local Exit Enter</pre>		
	Select type of clock source.	For BRI, select LOOP.	select Enter.
<p>NOTE: To select a PR1/100D module as your primary clock source, select Local. See your System Programming Guide (555-620-1 11) for more information</p>			
8	<pre>Primary Loop Clk Slotxx: Enter port number (1-8) x Backspace Exit Enter</pre>		
	Enter the number of the port.	Dial the number of the port.	Type the number of the port.
9	Save your entry.	Select Enter.	Select F10
10	To return to System Programming menu	Select Exit two times.	Select F5 two times.

BRI Timers

The programmable times on the 800 CO-BRI module set the time limits for waiting for responses from the central office (CO). When no response is received from the CO, the system takes the appropriate corrective action.



CAUTION:

The factory settings for these timers are standard and rarely need to be changed. If you are not sure of the correct timer settings for your BRI lines, check with your authorized support representative before you make a change.

Incorrect settings can cause the BRI lines to malfunction.

Follow these procedures to program the timers on the 800 CO-BRI module.

The timers are:

- T200 Timer—the minimum time which Layer 2 must wait for an acknowledgment of an information frame before initiating retransmission procedures.
- T203 Timer—the maximum time for which the Layer 2 link can remain active.
- T303 Timer—the amount of time the system waits for the CO to respond when the system sends a SETUP message to initiate an outgoing call. Corrective action is taken if the timer expires before the CO responds with either a SETUP Acknowledge or a call Proceeding message.
- T305 Timer—the amount of time the system waits for the CO to respond when the system initiates a Disconnect message for call clearing. Corrective action is taken if the timer expires before the CO responds with either a Disconnect or RELEase message.
- T308 Timer—the amount of time the system waits for the CO to respond when the system sends a RELEase message for call clearing. Corrective action is taken if the timer expires before the CO responds with a RELEase COMplete message.

NOTE:

If you enter an invalid timer value, the number you enter is truncated to the closest valid value. For example, if you enter 45 for a timer that ranges from 0 through 30, 4 is recorded.

System Programming

Entering Programming

Console: Select Menu → Sys Program → Exit

PC/SPM: Type `SPM` → Select any key → **F** → **F5**

Exiting Without Changes

To exit from any screen without making changes, select `Exit` on the console or press **F5** on the PC before saving your entry or menu selection.

Summary BRI Timers



Programmable by	System technician; system manager
Mode	Key, Hybrid/PBX
Idle Condition	Not required
Planning Form	System Form 3e, Outside Lines—BRI Options
Factory Setting	See Table 5-1.
Valid Entries	See Table 5-1.
Inspect	No
Copy Option	No
Console Procedure	LinesTrunks → More → BRI → Timers → Select timer → Dial value → Enter → Exit → Exit → Exit
PC Procedure	F4 → PgUp → F7 → F3 → Select timer → Type Value → F10 → F5 → F5 → F 5

System Programming

Table 5-1. BRI Timer Settings

Timer	Description	Factory Setting	Valid Range
T200	Minimum wait before retransmission	1000 ms	1000-2500 ms in increments of 500 ms
T203	Maximum time between messages	33,000 ms	10,000-33,000 ms in increments of 500 ms
T303	Setup timeout	2500 ms	1000-4000 ms in increments of 500 ms
T305	Disconnect timeout	4 seconds	4-30 seconds in increments of 1 second
T308	Release timeout	4 seconds	2-10 seconds in increments of 1 second

Procedure: BRI Timers

Step	Display/Instructions	On the console	On the PC
1	<pre>System Programing: > Make a selection System Extensions SysRenumbr Opt ions Operator Tables LinesTrunks AuxEquip Exit NightSrvce</pre> <p>Select the LinesTrunks menu.</p>	Select LinesTrunks.	Select  .
2	<pre>Lines and Trunks: > Make a selection LS/GS/DSL PRI TIE Lines copy TT/LS Disc RemoteAccss DID Pools Exit Toll Type</pre> <p>Move to the second page of the Lines and Trunks menu.</p>	Select More .	Select PgUp .
3	<pre>Lines and Trunks: > Make a selection HoldDiscnct ClockSync PrncipalUsr BRI QCC Prior QCC Oper Exit</pre> <p>Select BRI.</p>	Select BRI.	Select  .

System Programming

Step	Display/Instructions	On the console	On the PC
4	<pre>BRI Lines: Make a selection ServProf Id Timers Exit</pre> <p>Select Timers.</p>	Select Timers.	Select F3 .
5	<pre>BRI Timer Settings: Make a selection T200 Timer T308 Timer T203 Timer T303 Timer T305 Timer Exit</pre> <p>Select the timer.</p>	Select the timer. F2 , F3 ,	Select the time (F1 , F4 , or F6).
6	<pre>BRI Txxx Timer: (Display varies depending on timer) Backspace Exit Enter</pre> <p>Erase current setting.</p>	Select Drop .	Select Alt + P .
7	Specify new setting by using Table 5-1.	Dial [nnnn].	Type [nnnn].
8	Save your entry.	Select Enter .	Select F10 .
9	To return to System Programming menu	Select Exit three times.	Select F5 three times.

BRI Access Button

The BRI Access button is used for the CO Transfer feature and to select a Directory Number for which a Local Area Signaling Service (LASS) feature is activated. However, it is not used to place or receive calls.

The BRI Access button is programmed onto one of the first ten buttons on a multiline telephone. Only one BRI Access button can be on a telephone. The BRI Access button can be copied from one station to another programmed station via the Extension Copy feature.



A BRI Access button cannot be programmed onto:

- Single-line telephone or other tip/ring stations.
- Queued Call Console (QCC).

Except for during a CO Transfer, pressing a BRI Access button is ignored when the telephone is off-hook.

Follow these procedures to program a BRI Access button onto a multiline telephone. They are the same steps used for Centralized Telephone Programming.

Entering Programming

Console: Select **Menu** → Sys Program → Exit
PC/SPM: Type **SPM** → select any key →  → 

Exiting Without Changes

To exit from any screen without making changes, select **Exit** on the console or press  on the PC before saving your entry or menu selection.

Summary: BRI Access Button

Programmable by	System technician, system manager
Mode	Key, Hybrid/PBX
Idle Condition	Telephone must be idle
Planning Forms	System Form 4b, Analog Multiline Telephones System Form 4b, Digital/ISDN Telephone System Form 5a, Direct-Line Console (DLC)Analog System Form 5b, Direct-Line Console (DLC)- Digital/ISDN
Factory Setting	None
Valid Entries	Not applicable
Inspect	Yes, through station inspect
Copy Option	Yes

Console Procedure

To program extension:











More → Cntr-Prg → Program Ext → Dial extension no. → Enter → Start → Select button on telephone → ListFeature → BRI Access → Sys Prog → Exit → Exit → **More**

To copy extension programming:





More → Cntr-Prg → Copy Ext. → Dial copy from ext. no. → Enter → Dial copy to ext. no. → Enter → Exit → Exit → **More**

PC Procedure

To program extension:

PgUp →  → F1 → Specify telephone →  → F10
→ Select the function key for the telephone button →  → , , , or , depending on the type of station or telephone →  →  →  → PgUp

NOTE:

Depending on the type of station or telephone, the position of the BRI Access field on the display may correspond to , ,  or .

System Programming



To copy extension programming:

PgUp → **F4** → **F2** → Type copy from ext. no. → **F10**
 → Type copy to ext. no. → **F10** → **F5** → **F5** → **F5** → **PgUp**



Procedure: BRI Access Button

Step	Display/Instructions	On the console	On the PC
1	<pre>System Programming: > Make a selection System Extensions SysReNumber Options Operator Tables LinesTrunks AuxEquip Exit NightSrvce</pre> <p>Go to the second screen of the System Programming menu.</p>	Select More .	Select PgUp ,
2	<pre>System Programming: > Make a selection Labeling Language Data Print Cntr-Prg Exit</pre> <p>Select Centralized Programming.</p>	Select Cntr-Prg.	Select F4 .
3	<pre>Centralized Programming: Make a selection Program Ext COPY Ext Exit</pre> <p>Select Program Extension.</p>	Select Program Ext.	Select F1 .
4	<pre>Centralized Programming: Enter extension xxxx Backspace Exit Enter</pre> <p>Enter the telephone extension number.</p>	Dial <i>[nnnn]</i> .	Type <i>[nnnn]</i> .
5	Save your entry.	Select Enter .	Select F10 .

System Programming

Step	Display/Instructions	On the console	On the PC
6	<pre> Extension Program Xxxx: Press HOME to Exit Sys Program Start </pre>	Select Start.	Select  .
7	<pre> Select Button: Extension Program xxxxx Page 1 Page 2 Sys Program </pre>	Select one of the first ten buttons on your telephone. Select the button the telephone.	Select the function key for the button on the telephone.
8	<pre> Blank Press HOME to Exit Delete Page 1 Page 2 Sys Program ListFeature </pre>	Select ListFeature.	Select  .
9	<pre> Select a Feature: > Extension Program xxxxx FindFeature AutoAnsIcom AccountCode AutoLineSel Alarm Barge In Auto Dial BRI Access AutoAns All CallWaiting> </pre>	Select BRI Access.	Select  .
<p>NOTE: Screen may be different, depending on the telephone being programmed.</p>			

System Programming

Step	Display/Instructions	On the console	On the PC
10	<div style="border: 1px solid black; padding: 5px; width: fit-content;"><p>Select Button: Extension Program xxxx Page 1 Page 2</p><p>Sys Program</p><p>Return to System Programming.</p></div>	Selects Sys Program.	Select 
11	To return to System Programming menu	Select Exit two times and press More .	Select  and then PgUp.

System Programming Reports

The System Programming Reports are revised to include the following BRI information:

- System Information Report adds “800 CO-BRI” to its module types.
- Extension Information Report adds “BRI Access” to its button types.
- Error Log Report includes the new errors associated with BRI functioning (see Chapter 6, *Maintenance*).
- General Trunk Information report includes 800 CO-BRI module information.

In addition to these, a new report, the BRI Information report, has been created for BRI information (see Figure 5-1). For each BRI line this report includes the line number and the Service Profile Identifier (SPID) and the Calling Party Number (CPN) to be sent to the called party.

These reports are accessed by selecting the Print option from the System Programming menu.

```
BRI INFORMATION
Line      Service Profile Id
Xxxx     XXXXXXXXXXXX
```

Example:

```
Line      Service Profile Id
 801     0155512340
```

Figure 5-1. BRI Information Report

Maintenance

6

Maintenance on the MERLIN LEGEND Communications System consists of automatic and demand tests and error messages. Similarly, there are automatic and demand tests that run on the 800 CO-BRI module. Errors appear in error logs, and error messages appear on the maintenance terminal display (the MLX-20L telephone or the PC).

BRI Maintenance

Maintenance for the Basic Rate Interface (BRI) focuses on the functioning of the 800 CO-BRI module. Because the MERLIN LEGEND system is using those BRI features offered by the central office (CO), the system maintenance is the responsibility of the CO. Still, there are automatic and demand tests that check the functioning of the module, logs in which errors are recorded, error messages that tell the user when errors occur, and alarms that also alert the user to errors.

Maintenance for the BRI is similar to maintenance for other modules: the status of the module can be viewed on the Slot Status screen, and additional information about the module is displayed by the System Inventory screen. Like other modules, the 800 CO-BRI module must be “busied-out” or reset before demand tests or replacement can be done. (See the *Installation, Programming, and Maintenance* manual, 555-620-140, for more information on basic maintenance procedures.)

The demand tests associated with BRI maintenance are:

- Internal (DSE) Loopback test (located on the Demand Test menu)
- Board Controller test (located on the Demand Test menu)
- B-Channel Loopback test (located on the Slot menu)

In addition, users can check the following information:

- Clock status of the 800 CO-BRI module
- Digital Subscriber Line (DSL) error events
- Error logs

Accessing Maintenance Screens

Accessing the maintenance screens in the MERLIN LEGEND BRI system is the same as for other MERLIN LEGEND releases. Follow the screens and instructions below.

Step	Screen Display	Procedure
1	<pre>18 Sep 18:34 Show. Number Next Page</pre>	While viewing the Home screen, press Menu.
2	<pre>MENU MODE: Select Feature Press HOME to Exit Directory Messages Posted Msg Sys Program Alarm Clock Maintenance Timer Ext Program</pre>	At the Menu Mode screen, select Maintenance.
3	<pre>Maintenance: Make a selection System slot Port Exit</pre>	<p>The Maintenance menu is displayed.</p> <p>Select System for an overview of modules and error conditions.</p> <p>Select Slot for information specific to a slot and for busy-outs and demand tests.</p> <p>Select Port to view information specific to a port.</p>

Demand Tests

Demand tests are diagnostic tests that check the functioning of hardware and software.

Before running a demand test, the user must take the 800 CO-BRI module out of service. This can be done by choosing “Busy-Out” or “Reset” from the slot maintenance screens. Choosing Busy-Out is preferred because Busy-Out does not disrupt calls in progress. Busy-Out and Reset work the same for the 800 CO-BRI module as they do for any module (see the *Maintenance and Troubleshooting* manual, #555-620-143).

Three demand tests can be run on the 800 CO-BRI module: the Board Controller Test, the Internal (DSE) Loopback Test (DSE is the abbreviation for ‘digital switching element’), and the B-Channel Loopback Test. The first two tests are run from the Demand Test menu. The B-Channel Loopback Test is selected from the Slot menu.

These three tests should be run in the following order:

1. Internal Loopback Test
2. Board Controller Test
3. B-Channel Loopback Test

Internal (DSE) Loopback Test

The Internal (DSE) Loopback Test checks the communication path between the Processor module and the 800 CO-BRI module. If the test fails, the 800 CO-BRI module usually should be replaced.

Follow the screens and instructions below to run an Internal Loopback Test.

Step	Screen Display	Procedure
1	<pre>slot : Enter slot number (00-17) xx Backspace Exit Enter</pre>	At the Slot screen, enter the number of the slot in which the 800 CO-BRI module resides. Select Enter.
2	<pre>slot xx: Make a selection Status Demand Test Busy-Out Reset Restore Clock BchLoopback Exit</pre>	At the menu for that slot, select Busy-out.
3	<pre>Busy-Out Slot xx: Do you want to continue? Yes Cancel Exit</pre>	At the Busy-Out Slot screen, select Yes.
4	<pre>Busy-Out Slot xx: Busy-Out Complete Exit</pre>	When the busy-out of the slot is complete, the Busy-Out Complete screen appears. Select Exit. NOTE: If the busy-out cannot be completed, a screen showing "Busy-Out FAILED" appears. Repeat steps 2 through 4 until the slot can be busied-out.

Step	Screen Display	Procedure
5	<pre>slot xx: Make a selection Status Demand Test Busy-Out Reset Restore Clock BchLoopback Exit</pre>	<p>You return to the menu for that slot. Select Demand Test.</p>
6	<pre>Demand Test Slot xx: Make a selection Note:Busy out slot first BoardCntrlr IntLoopback Exit</pre>	<p>At the Demand Test Slot screen, select IntLoopback.</p>
7	<pre>Demand Test Slot xx: Board 800 CO-BRI Internal Loopback: Test Once Repetitive Exit</pre>	<p>Select Test Once for a single testing Or Repetitive for repeated testing.</p>
8	<pre>Demand Test Slot xx: Board 800 CO-BRI Internal Loopback Test in Progress Exit</pre>	<p>The internal Loopback Test in Progress screen appears. The test takes approximately one minute to run.</p>
9	<pre>Demand Test Slot xx: Board 800 CO-BRI Internal Loopback Test Successfully Completed Exit</pre>	<p>If the test is successful, you receive a “Successfully Completed” message.</p>

Maintenance

Step	Screen Display	Procedure
10	<pre>Demand Test Slot xx: Board 800 CO-BRI Internal Loopback Test FAILED XXXXXXXXXXXXXXXXXXXXXXXXX xx xx xx xx xx xx xx xx Exit</pre>	If the test fails, you receive error messages and error counts.

After the test is run, restore the 800 CO-BRI module and exit maintenance as you would for any demand test (see the *Maintenance and Troubleshooting Guide*, #555-620-143).

Board Controller Test

The Board Controller Test checks the circuitry, firmware, and other electronic elements of the 800 CO-BRI module. If the module fails the test, it usually should be replaced. If the test fails during the firmware test, one or more of the following messages appear on the MLX-20L telephone or PC display:

- Boot ROM Failure
- RAM Failure
- Timer Failure
- Transceiver Failure
- HDLC Failure
- Flash ROM Failure
- Dual Port RAM Failure

Maintenance

Follow the screens and instructions below to run a Board Controller Test,

Step	Screen Display	Procedure
1	<pre>slot : Enter slot number (0 0-17) xx Backspace Exit Enter</pre>	At the Slot screen, enter the number of the slot in which the 800 CO-BRI module resides. Select Enter.
2	<pre>slot xx: Make a selection Status Demand Test Busy-Out Reset Restore Clock BchLoopback Exit</pre>	At the menu for that slot, select Busy-Out,
3	<pre>Busy-Out Slot xx: Do you want to continue? Yes Cancel Exit</pre>	At the Busy-Out Slot screen, select Yes.
4	<pre>Busy-Out Slot XX: Busy-Out Complete Exit</pre>	<p>When the busy-out of the slot is complete, the Busy-Out Complete screen appears. Select Exit.</p> <p>NOTE: If the busy-out cannot be completed, a screen shows "Busy-Out FAILED." Repeat steps 2 through 4 until the slot can be busied-out.</p>
5	<pre>S l o t x x : Make a selection Status Demand Test Busy-Out Reset Restore Clock BchLoopback E x i t</pre>	You return to the menu for that slot. Select Demand Test.

Maintenance

Step	Screen Display	Procedure
6	Demand Test Slot xx: Make a selection Note:Busy out slot first BoardCntrlr IntLoopback Exit	At the Demand Test Slot screen, select BoardCntrlr.
7	Demand Test Slot xx: Board 800 CO-BRI Board Controller: Test Once Repetitive Exit	Select Test Once for a single test Repetitive for repeated testing.
8	Demand Test Slot xx: Board 800 CO-BRI Board Controller Test in Progress Exit	The Board Controller Test in Progress screen is displayed. NOTE: This screen scrolls quickly.
9	Demand Test Slot xx: Board 800 CO-BRI Board Controller Test Successfully Completed Exit	If the test was successful, you receive a "Successfully Completed" message.
	Demand Test Slot xx: Board 800 CO-BRI Board Controller Test FAILED XXXXXXXXXXXXXXXXXXXXXXXXXXXXXXXX XXXXXXXXXXXXXXXXXXXXXXXXXXXXXXXX Exit .	If the test failed, you receive error messages, Press More to get a screen listing more errors.

Maintenance

After the test is run, restore the 800 CO-BRI module and exit maintenance as you would for any demand test (see the *Maintenance and Troubleshooting Guide*, #555-620-143).

B-Channel Loopback Test

The B-Channel Loopback Test checks the communication path between the Processor module and the 800 CO-BRI module interface for BRI lines. If the test fails, the 800 CO-BRI module usually should be replaced. Follow the screens and instructions below to run a B-Channel Loopback Test.

Step	Screen Display	Procedure
1	<pre>slot: Enter slot number (00-17) xx Backspace Exit Enter</pre>	At the Slot screen, enter the number of the slot in which the 800 CO-BRI module resides. Select Enter.
2	<pre>slot xx: Make a selection Status Demand Test Busy-Out Reset Restore Clock BchLoopback Exit</pre>	At the menu for that slot, select Busy-Out.
3	<pre>Busy-Out Slot XX: Do you want to continue? Yes Cancel Exit</pre>	At the Busy-Out Slot screen, select Yes.

Maintenance

Step	Screen Display	Procedure
	<pre>Busy-Out Slot XX: Busy-Out Complete Exit</pre>	<p>When the busy-out of the slot is complete, the Busy-Out Complete screen is displayed. Select <code>Exit</code>.</p> <p>NOTE:</p> <p>If the busy-out cannot be completed, a screen showing "Busy-Out FAILED" appears. Repeat steps 2 through 4 until the slot can be busied-out.</p>
5	<pre>Slot xx: Make a selection Status Demand Test Busy-Out Reset Restore Clock BchLoopback Exit</pre>	<p>You return to the Slot menu. Select <code>BchLoopback</code>.</p>
6	<pre>BchLoopback slot xx: BchLoopback in Progress Exit</pre>	<p>The B-Channel Loopback in Progress screen is displayed.</p>
7	<pre>BchLoopback Slot xx: BchLoopback passed Exit</pre>	<p>If the test is successful, this screen is displayed.</p>

Maintenance

Step	Screen Display	Procedure
8	<pre>BchLoopback Slot xx: BchLoopback Failed XXXXXXXXXXXXXXXXXXXXX xx xx xx xx xx xx xx Exit</pre>	If the test fails, you receive error messages and error counts.

After the test is run, restore the 800 CO-BRI module and exit maintenance as you would for any demand test (see the *Maintenance and Troubleshooting Guide*, 555-620-143).

BRI Module and Clock Synchronization

The time-division multiplex (TDM) clock reference for the system can be a loop source supplied by the CO, or a local source supplied by the MERLIN LEGEND system during certain maintenance conditions and events. The 800 CO-BRI module can be a local source of clock reference, and any Digital Subscriber Line (DSL) port on the 800 CO-BRI module can be the point of a loop source.

If the 800 CO-BRI module is being used as the local clock source for the system, or if one of the DSL ports is being used as the loop clock source, the maintenance software searches for another clock source when the BRI module or DSL port is busied out or reset. The software chooses the programmed secondary clock source; if the secondary source is not available, it chooses the tertiary clock source.

If no programmed clock sources are available, the software searches the system from the first slot to the last in the following order:

1. The first 100D module or 800 CO-BRI module port found is used as the loop clock source.
2. Local clock source (first one found is used).
3. Local clock on the Processor module; the software uses this clock as the system clock.

When the 800 CO-BRI module or DSL port is restored, the maintenance software restores the module or port as the clock source if the module or port is a higher priority clock source than the one currently running. For example, if the 800 CO-BRI module is the primary clock source for the system, once the 800 CO-BRI module is restored, the software transfers the system clock source back to the 800 CO-BRI module.

The 800 CO-BRI Module as the Clock Source

If the 800 CO-BRI module functions as the local clock source, the maintenance software monitors all frame slip counters associated with all the activated Digital Subscriber Line (DSL) ports on the module. (A DSL port is activated when it has at least one Service Profile Identifier assigned to it.) When the counters reach an alarm level, the local clock is considered to be defective and is deactivated; the software switches the clock to another module, in the order described above.

When the slip alarm is removed, the software switches the clock back to the 800 CO-BRI module, if the module has a higher clock priority than the source currently being used.

A DSL Port as the Clock Source

If one of the DSL ports is used as the loop clock source, the maintenance software monitors that DSL's frame slip counter. When the counter reaches an alarm level, the maintenance software deactivates the DSL port as the clock source and finds another clock source, in the order described above. This error condition is called "BRI SLIPS >88" and is a transient error.

When the software detects a loss of synchronization or a network deactivate condition, called "BRI LOSS OF SYNC" or "BRI NET DEACTIVATE," the software deactivates the DSL port as a clock source and finds another source. These errors are permanent errors.

When the maintenance software detects that the above DSL port alarms have been removed, it switches the clock source back to the DSL port if the port has a higher clock priority than the source currently being used.

Maintenance

BRI Clock Status

The status of the clock on the 800 CO-BRI module can be viewed by selecting clock from the Slot menu.

Follow the screens and instructions below to check the clock status of the 800 CO-BRI module.

Step	Screen Display	Procedure
1	<pre>slot : Enter slot number (00-17) xx Backspace Exit Enter</pre>	At the Slot screen, enter the number of the slot in which the 800 CO-BRI module resides. Select Enter.
2	<pre>Slot xx: Make a selection Status Demand Test Busy-Out Reset Restore Clock BchLoopback Exit</pre>	At the menu for that slot, select Clock.
3	<pre>Clock Slot xx: mm/dd/yy hh:oo-hh:mm Active: Synch source: Port: Exit</pre>	The Clock Slot screen displays the clock information for the 800 CO-BRI module. A yes or no appears next to Active. Loop or Local appears next to Synch source. The number of the port (1-8) being used appears next to Port.

NOTE:

The Synch source and Port fields are relevant only if the Active field is Yes.

Port Screens—Digital Subscriber Lines

The ports on the 800 CO-BRI module are linked to Digital Subscriber Lines (DSLs). Therefore, a DSL option has been added to the Port menu. By choosing DSL from this menu, the user can check the status of, busy-out, restore, or check the error events for the DSL port.

Follow the screens and instructions below to get to the DSL menu.

Step	Screen Display	Procedure
1	<pre> Port: Make a selection Line /Trunk Modem Station B-Channel RS232 Port1 DSL RS232 Port2 Exit </pre>	From the Port menu, select DSL.
2	<pre> DSL : Enter DSL (sspp) xxxx Backspace Exit Enter </pre>	Enter the DSL slot and port number and select Enter. NOTE: The slot number ranges from 01 to 17; the port number ranges from 01 to 08 for the 800 CO-BRI module.
3	<pre> DSL xxxx: Make a selection Status Busy Out Restore Error Events Exit </pre>	At the DSL port menu, select the option you want, and proceed as you would for any other port on the system (see the <i>Maintenance and Troubleshooting Guide</i> , (555-620-143).

Digital Subscriber Line Error Events

To check the error events for a Digital Subscriber Line (DSL), the user must access the maintenance screens via the DSL port menu.

Follow the screens and instructions below to check the error events for a DSL.

Step	Screen Display	Procedure
1	DSL XXXX : Make a selection Status Busy Out Restore Error Events Exit	From the DSL port menu, select Error Events.
2	Error Events DSL xxxx: Make a selection Current hr Previous hr Exit	At the Error Events screen for that DSL, select either current hr or Previous hr. In this case, Current hr was selected.
3	Current hr DSL xxxx: mm/dd/yy hh:00-hh:mm CurAlm aaaa MaxAlm aaaa SLIPS NEBES FEBES Xxxxx xxxxx Xxxxx Exit	The Current hr DSL screen shows the errors that have occurred within the last hour. When you are done viewing the errors, select Exit.

Error Logs and Error Messages

There are two types of errors and two types of alarms:

- Permanent errors, which cause permanent alarms
- Transient errors, which cause transient alarms

A permanent error causes major degradation of service and requires immediate action. A permanent error is recorded in the permanent error log and causes a permanent alarm. This permanent alarm can also trigger the external system alarm, which turns on the red LED on the 800 CO-BRI module for circuit board or port errors, turns on the programmed alarm LEDs on telephones, and seizes the programmed alarm facility.

A transient error causes a reduced level of service, but the system continues to operate normally. If a given threshold is exceeded, a transient error can become a permanent error. A transient error is recorded in the transient error log.

Both permanent and transient errors are removed from their error logs when the system returns to normal operation. The user can also manually remove these errors from their logs while viewing the error log by pressing the Drop button on the MLX-20L telephone or by pressing ALT-P on the PC used for programming.

Errors

Errors are reported by the automatic maintenance tests that scan the 800 CO-BRI module's shared memory status registers and counters. Port-related errors show the specific port affected.

NOTE:

Synchronization and central office-induced errors are tracked only on Digital Subscriber Lines (DSLs) for which a Service Profile Identifier (SPID) has been assigned to one of the facilities on the DSL. However, if no SPIDs have been assigned to any of the facilities on any of the DSLs (for example, on initial system power-up), errors are tracked on all DSLs until the first SPID is assigned. When the first SPID is assigned, all alarms for DSLs not associated with SPIDs are removed.

Table 6-1. Error Conditions

Type of Error	Abbrev.	Permanent?	Transient?	Sys. Alarm?
BRI LOSS OF SYNC	SYNC	Yes	No	Yes
BRI SLIPS >88	—	No	Yes	No
BRI NET REQUESTED CCRCs	CCRC	No	Yes	No
BRI NET DEACTIVATE	DEAC	Yes	No	Yes
BRI NET INV 2B+D LB ACT	2B+D	Yes	No	Yes
BRI NET INV B1 LB ACT	B1LB	Yes	No	Yes
BRI NET INV B2 LB ACT	B2LB	Yes	No	Yes
BRI NET INV IL LB ACT	ILLB	Yes	No	Yes
BRI NET INV QM LB ACT	QMLB	Yes	No	Yes
ENDPT IN RESTRICTED SVCE	T e x t	Yes	No	Yes
LINK ESTABLISHMENT FAIL	—	Yes	No	Yes
ENDPOINT UNINIT (L2, L3)	—	Yes	No	Yes
NW TOOK ENDPOINT 00S	—	No	Yes	No
NW NOT RESPOND TO SETUP	—	Yes	No	Yes
NW NOT RESPOND TO RELEAS	—	Yes	No	Yes
NEBEs	—	No	No	No
FEBEs	—	No	No	No

Synchronization Errors

Some errors occur because of loss of synchronization in framing.

Loss of Synchronization (BRI LOSS OF SYNC)

A loss of synchronization occurs when the synchronization word for establishing basic framing and/or the inverted synchronization word for establishing the superframe has not been detected for 480 milliseconds (ins). A loss of synchronization is a permanent error and causes the system reaction for permanent errors, as described above. The facilities affected by the loss of synchronization are taken out of service until the error condition is removed.

Slips (BRI SLIPS > 88)

A slip occurs when there is the loss of a frame because of clock synchronization. When the slips (negative plus positive) count is greater than 88, a transient error occurs. Once the error is logged, every 15 minutes the slips count is scanned and totaled. Also, every 15 minutes the count is decreased by 10. For example, if 15 slips occur during the 15-minute interval, the transient count increases by a net of 5 (15 slips counted minus 10). The transient alarm condition is automatically removed from the transient error log when the slip counter value decreases to 0.

Central Office-Induced Errors

The 5ESS central office (CO) deliberately sends or receives incorrect information to test the transmission paths between the CO and the MERLIN LEGEND system.

Network-Requested Corrupted CRCs (BRI NET REQUESTED CCRCs)

In this error condition, the CO requests that the 800 CO-BRI module send bad CRCs in the frames. The errors are transient and are listed in the transient error log. When the condition returns to normal operation, the maintenance software clears this error from the log.

Network Deactivation (BRI NET DEACTIVATE)

If the deactivation bit in a transmission is set to zero by the CO, the transceiver in the 800 CO-BRI module deactivates Layer 1 on a DSL. The red LED on the BRI module lights, and the condition is logged as a permanent error. Maintenance software takes the facilities affected out of service. When the condition returns to normal operation, the red LED goes off, the error log entry is removed, and the facilities are put back into service.

Network-Invoked 2B+D Loopback Activation (BRI NET INV 2B+D LB ACT)

The 2B+D loopback testis invoked by the CO at installation to verify error-free transmission. When the MERLIN LEGEND system receives this request from the CO, the maintenance software turns on the red LED on the 800 CO-BRI module, logs the condition as a permanent error, and takes the affected facilities out of service. When the condition returns to normal operation, the red LED goes off, the error log entry is removed, and the facilities return to service.

Network-Invoked B1 Loopback Activation (BRI NET INV B1 LB ACT)

The B1 loopback test is invoked by the CO at installation to verify error-free transmission. When the MERLIN LEGEND system receives this request from the CO, the maintenance software turns on the red LED on the 800 CO-BRI module, logs the condition as a permanent error, and takes the B-channel out of service. When the condition returns to normal operation, the red LED goes off, the error log entry is removed, and the B-channel returns to service.

Network-Invoked B2 Loopback Activation (BRI NET INV B2 LB ACT)

The B2 loopback test is invoked by the CO at installation to verify error-free transmission. When the MERLIN LEGEND system receives this request from the CO, the maintenance software turns on the red LED on the 800 CO-BRI module, logs the condition as a permanent error, and takes the B-channel out of service. When the condition returns to normal operation, the red LED goes off, the error log entry is removed, and the B-channel returns to service.

Network-Invoked Insertion Loss Loopback Activation (BRI NET INV IL LB ACT)

The Insertion Loss loopback test is invoked by the CO at installation to verify the transmission parameters of the loop. When the MERLIN LEGEND system receives this request, the maintenance software turns on the red LED on the 800 CO-BRI module, logs the condition as a permanent error, and takes the affected facilities out of service. When the condition returns to normal operation, the red LED goes off, the error is removed from the permanent log, and the facilities return to service.

Network-Invoked Quiet Mode Loopback Activation (BRI NET INV QM LB ACT)

The Quiet Mode loopback test is invoked by the CO at installation to verify the transmission parameters of the loop. When the MERLIN LEGEND system receives this request, the maintenance software turns on the red LED on the 800 CO-BRI module, logs the condition as a permanent error, and takes the affected facilities out of service. When the condition returns to normal operation, the red LED goes off, the error is removed from the permanent log, and the facilities return to service.

Endpoint Errors

Endpoint is in RESTRICTED mode (ENDPT IN RESTRICTED SVCE)

When the MERLIN LEGEND system is initializing an endpoint, it sends an initialization request message, which contains the Service Profile Identifier (SPID), to the CO. If the SPID is invalid, the CO sends back a message that the endpoint is in RESTRICTED SERVICE mode. In this mode, the CO usually blocks any outgoing calls. When this error is received, the technician should verify the SPID and reprogram it.

Endpoint establishment failed (LINK ESTABLISHMENT FAIL)

When this message is received by the MERLIN LEGEND system, the link establishment request has failed. In other words, the link was not established before the associated timer expired. Either there is a problem with the port on the 800 CO-BRI module or the line has not been properly activated by the CO.

Endpoint uninitialized (ENDPOINT UNINIT L2/L3)

When Layer 1 is up but Layer 2 and/or 3 is down for an endpoint, this error is logged. If this error does not disappear, there is a problem either with the port or at the CO.

Network took endpoint out of service (NW TOOK ENDPOINT OOS)

This error is logged when the MERLIN LEGEND system tries to put an endpoint in service and the network responds by taking it out of service,

SETUP and RELEase Message Errors

Network not responding to a SETUP message (NW NOT RESPOND TO SETUP)

Network not responding to a RELEase message (NW NOT RESPOND TO RELEAS)

If the MERLIN LEGEND system sends a SETUP or RELEase message and the CO does not respond with the appropriate message before the BRI timer expires, the system sends the message again. If the CO still does not respond in time, the system tears down the call and logs this error,

Minor Errors

Near-End Block (CRC) Errors (NEBEs)

When a transceiver on the 800 CO-BRI module receives a superframe that has a bad CRC error, the condition is called a Near-End Block Error (NEBE). Automatic maintenance programs scan the NEBE error counter every 15 minutes and clear it hourly. The total NEBE count is kept for the previous hour and the current hour. NEBE errors are not permanent or transient errors; therefore, no action is taken. However, the NEBE count does appear on the maintenance screens.

Far-End Block (CRC) Errors (FEBEs)

When the receiver on the 5ESS central office's BRI circuit module receives a superframe that has a bad CRC error from the MERLIN LEGEND's 800 CO-BRI module, the error condition is called a Far-End Block Error (FEBE). Automatic maintenance programs scan the FEBE error counter every 15 minutes and clear it hourly. The total FEBE count is kept for the previous hour and the current hour. FEBE errors are not permanent or transient errors; therefore, no action is taken. However, the FEBE count does appear on the maintenance screens.

Error Messages

Along with alarm indicators, error messages are the best indicators that an error has occurred in the system. Error messages appear on the displays of the MLX-20L telephone or the PC used for maintenance (System → *Error Log* → *Last 30, Permanent, or Transient*). Table 6-2 lists the error messages and the possible solutions for each. Because many of the errors are caused by tests invoked by the CO, the system technician has little to do on the MERLIN LEGEND side.

NOTE:

Routine maintenance tests performed by the CO on BRI lines can result in the appearance of invalid "BRI errors" as the last 30 errors in your log.

Table 6-2. BRI Error Messages

Code	Description of Error	Possible Solution
6COC	BRI LOSS OF SYNC: Service on the link has been lost.	Usually no action is required. Check the BRI module. If problem persists, contact the National Technical Service Center (NTSC).
6COD	BRI SLIPS > 88: Slip count > 88 Service on the link is still operative.	Usually no action is required. Check the BRI module. If problem persists, contact the NTSC.
6COE	BRI NET REQUESTED CCRCs: Outgoing signal to the CO does not have valid framing information. Service on the link is still operative.	Usually no action is required. The link should return to normal once the test is completed. If problem persists, contact the NTSC.
6COF	BRI NET DEACTIVATE: Layer 1 on the link is down. Service on the link has been lost.	Usually no action is required. The link should return to normal once the test is completed. If problem persists, contact the NTSC.
6C10	BRI NET INV 2B+D LB ACT: Service on the link has been lost.	Usually no action is required, The link should return to normal once the test is completed. If problem persists, contact the NTSC.
6C11	BRI NET INV B1 LB ACT: Service on the link has been lost.	Usually no action is required. The link should return to normal once the test is completed. If problem persists, contact the NTSC.
6C12	BRI NET INV B2 LB ACT: Service on the link has been lost.	Usually no action is required. The link should return to normal once the test is completed. If problem persists, contact the NTSC.
6C13	BRI NET INV IL LB ACT: Service on the link has been lost.	Usually no action is required. The link should return to normal once the test is completed. If problem persists, contact the NTSC.
6C14	BRI NET INV QM LB ACT: Service on the link has been lost.	Usually no action is required. The link should return to normal once the test is completed. If problem persists, contact the NTSC.

Table 6-2. BRI Error Messages (Continued)

Code	Description of Error	Possible Solution
3401	ENDPT IN RESTRICTED SVCE Service on the link has been lost.	Usually caused by an incorrect SPID. Check the SPID and reprogram as necessary.
9403	LINK ESTABLISHMENT FAIL Service on the link has been lost.	Check that the line is securely connected to the port and that the LEDs on the 800 CO-BRI module show proper operation. If the module is working properly, the line may not have been activated by the CO.
9404	NW NOT RESPOND TO SETUP Service on the link has been lost.	The CO is not responding to messages sent by the MERLIN LEGEND system. Contact the CO.
9405	NW NOT RESPOND TO RELEAS Service on the link has been lost.	The CO is not responding to messages sent by the MERLIN LEGEND system. Contact the CO.
9406	NW TOOK ENDPOINT OOS Service on the link has been lost.	The CO has taken the endpoint out of service. Contact the CO.
9407	ENDPOINT UNINIT (L2,L3) Service on the link has been lost.	Caused when Layer 1 is up but Layer 2 and/or 3 is down for an endpoint. If problem persists, contact the NTSC.

Planning Form

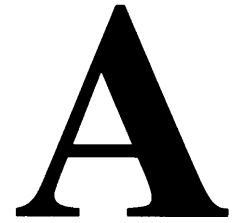

This appendix contains master copies of the system planning form you need to plan and program BRI lines/trunks connected to the system.

Duplicate the master and work on the copy.

MERLIN LEGEND Communications System — CO-BRI
 System Form 3e

Outside Line - BRI Options

Logical ID	Line Number	Directory Number	Service Profile Identifier	Features						
				ACP	CPN	AC	AR	COT	MLHG	MLPP
0 1	8 0 1	5 5 5 - 1 2 3 4	1 0 5 5 5 1 2 3 4 0							
0 2	8 0 2	5 5 5 - 1 2 3 5	1 0 5 5 5 1 2 3 5 0							
0 3										

◆ = Factory Setting -

ACP = All-Call Privacy/Per-Call Privacy
 CPN = Calling Party Number/Billing Number
 AC = Automatic Callback
 AR = Automatic Recall
 COT = Customer Originated Trace
 MLHG = Multi-Line Hunt Group
 MLPP = Multi-Level Precedence and Preemption

Clock Synchronization — 100D or BRI Modules

Primary clock
Synchronization

Slot No. _____

DSL No. _____ (BRI only)

Source

Loop

Local(100D only)

Secondary Clock
Synchronization

Slot No. _____

DSL No. _____ (BRI only)

Source

Loop **◆**

Local (100D only)

Tertiary Clock
Synchronization

Slot No. _____

DSL No. _____ (BRI only)

Source

Loop **◆**

Local (100D only)

Timers

T200 Timer

1,000 ms. **◆**

_____ms. (1,000 to 2,500 ms.
in increments of 500 ms)

T203 Timer

33,000 ms. **◆**

_____ms. (10,000 to 33,000 ms.
in increments of 500 ms.)

T303 Timer

2,500 ms. **◆**

_____ ms. (1,000 to 4,000 ms.
in increments of 500 ms.)

T305 Timer

4 seconds **◆**

_____ seconds (4 to 30 seconds in
increments of 1 second)

T308 Timer

4 seconds **◆**

_____ seconds (2 to 10 seconds in
increments of 1 second)

◆ = Factory Setting

Customer Support Information

B

Support Telephone Number

In the U.S.A. only, AT&T provides a toll-free customer Helpline (1-800-628-2888) 24 hours a day. If you need assistance when installing, programming, or using your system, call the Helpline, or your AT&T representative.

Outside the U.S.A., if you need assistance when installing, programming, or using your system, contact your AT&T representative.

Federal Communications Commission (FCC) Electromagnetic Interference Information

This equipment has been tested and found to comply with the limits for a Class A digital device, pursuant to Part 15 of the FCC Rules. These limits are designed to provide reasonable protection against harmful interference when the equipment is operated in a commercial environment. This equipment generates, uses, and can radiate radio frequency energy and, if not installed and used in accordance with the instruction manual, may cause harmful interference to radio communications. Operation of this equipment in a residential area is likely to cause harmful interference, in which case the user will be required to correct the interference at his or her own expense.

FCC Notification and Repair Information

This equipment is registered with the FCC in accordance with Part 68 of its rules. In compliance with those rules, you are advised of the following:

- **Means of Connection.** Connection of this equipment to the telephone network shall be through a standard network interface jack, USOC RJ11 C, RJ14C, RJ21X. Connection to E&M tie trunks requires a USOC RJ2GX. Connection to off-premises extensions requires a USOC RJ11 C or RJ14C. Connection to 1.544-Mbps digital facilities must be through a USOC RJ48C or RJ48X. Connection to DID requires a USOC RJ11C, RJ14C, or RJ21X. These USOCs must be ordered from your telephone company.
- **Party Lines and Coin Telephones.** This equipment may not be used with party lines or coin telephone lines.
- **Notification to the Telephone Companies.** Before connecting this equipment, you or your equipment supplier must notify your local telephone company's business office of the following:
 - The telephone number(s) you will be using with this equipment.
 - The appropriate registration number and ringer equivalence number (REN), which can be found on the back or bottom of the control unit, as follows:
 - If this equipment is to be used as a Key system, report the number AS593M-72914-KF-E.
 - If the system provides both manual and automatic selection of incoming/outgoing access to the network, report the number AS593M-72682-MF-E.
 - If there are no directly terminated trunks, or if the only directly terminated facilities are personal lines, report the number AS5USA-65646-PF-E.
 - The REN (Ringer Equivalency Number) for all three systems is 1.5A.
 - For tie line connection, the facility interface code (FIC) is TL31M and the service order code (SOC) is 9. OF.
 - For connection to off-premises stations, the FIC is OL13C and the SOC is 9.0F.
 - For equipment to be connected to 1.544-Mbps digital service, the FIC is 04DU9-B for D4 framing format or 04 DU9-C for extended framing format, and the SOC is 6.OP.
 - For equipment to be connected to DID facilities, the FIC is 02RV2-T and the SOC is 9. OF.

- The quantities and USOC numbers of the jacks required.
 - For each jack, the sequence in which lines are to be connected, the line types, the FIC, and the REN by position when applicable.
- **Disconnection.** You must also notify your local telephone company if and when this equipment is permanently disconnected from the line(s).
 - **REN.** The REN is used to determine the number of devices that may be connected to the telephone line. Excessive RENs on the line may result in the devices not ringing in response to an incoming call. In most, but not all, areas the sum of the RENs should not exceed five (5.0). To be certain of the number of devices that may be connected to the line, as determined by the total RENs, contact the telephone company to determine the maximum REN for the calling area.

Installation and Operational Procedures

The manuals for your system contain information about installation and operational procedures.

- **Repair Instructions.** If you experience trouble because your equipment is malfunctioning, the FCC requires that the equipment not be used and that it be disconnected from the network until the problem has been corrected. Repairs to this equipment can be made only by the manufacturers, their authorized agents, or others who may be authorized by the FCC. In the event repairs are needed on this equipment, contact your authorized AT&T dealer or, **in the U.S.A. only**, contact the National Service Assistance Center (NSAC) at 1-800-628-2888.
- **Rights of the Local Telephone Company.** If this equipment causes harm to the telephone network, the local telephone company may discontinue your service temporarily. If possible, they will notify you in advance. But if advance notice is not practical, you will be notified as soon as possible. You will also be informed of your right to file a complaint with the FCC.
- **Changes at Local Telephone Company.** Your local telephone company may make changes in its facilities, equipment, operations, or procedures that affect the proper functioning of this equipment. If they do, you will be notified in advance to give you an opportunity to maintain uninterrupted telephone service.
- **Hearing Aid Compatibility.** The custom telephone sets for this system are compatible with inductively coupled hearing aids as prescribed by the FCC.

■ **Automatic Dialers.** WHEN PROGRAMMING EMERGENCY NUMBERS AND/OR MAKING TEST CALLS TO EMERGENCY NUMBERS:

- Remain on the line and briefly explain to the dispatcher the reason for the call.
- Perform such activities in off-peak hours, such as early morning or late evening.

■ **Direct Inward Dialing (DID).** This equipment returns answer supervision signals to the Public Switched Telephone Network when:

- Answered by the called station
- Answered by the attendant
- Routed to a recorded announcement that can be administered by the customer premises equipment user
- Routed to a dial prompt

This equipment returns answer supervision on all DID calls forwarded back to the Public Switched Telephone Network. Permissible exceptions are when:

- A call is unanswered
- A busy tone is received
- A reorder tone is received

Allowing this equipment to be operated in such a manner as not to provide proper answer supervision signaling is in violation of Part 68 rules.

Security of Your System: Preventing Toll Fraud

As a customer of a new telephone system, you should be aware that there is an increasing problem of telephone toll fraud. Telephone toll fraud can occur in many forms, despite the numerous efforts of telephone companies and telephone equipment manufacturers to control it. Some individuals use electronic devices to prevent or falsify records of these calls. Others charge calls to someone else's number by illegally using lost or stolen calling cards, billing innocent parties, clipping on to someone else's line, and breaking into someone else's telephone equipment physically or electronically. In certain instances, unauthorized individuals make connections to the telephone network through the use of remote access features.

The Remote Access feature of your system, if you choose to use it, permits off-premises callers to access the system from a remote telephone by using a telephone number with or without a barrier code. The system returns an acknowledgment signaling the user to key in his or her barrier code, which is selected and administered by the system manager. After the barrier code is accepted, the system returns dial tone to the user. If you do not program specific outward calling restrictions, the user will be able to place any call normally dialed from a telephone associated with the system. Such an off premises network call is originated at, and will be billed from, the system location.

The Remote Access feature, as designed, helps the customer, through proper administration, to minimize the ability of unauthorized persons to gain access to the network. Most commonly, phone numbers and codes are compromised when overheard in a public location, through theft of a wallet or purse containing access information, or through carelessness (for example, writing codes on a piece of paper and improperly discarding it). Additionally, hackers may use a computer to dial an access code and then publish the information to other hackers. Enormous charges can be run up quickly. It is the customer's responsibility to take the appropriate steps to properly implement the features, evaluate and administer the various restriction levels, protect access codes, and distribute access codes only to individuals who have been fully advised of the sensitive nature of the access information.

Common carriers are required by law to collect their tariffed charges. While these charges are fraudulent charges made by persons with criminal intent, applicable tariffs state that the customer of record is responsible for payment of all long-distance or other network charges. AT&T cannot be responsible for such charges and will not make any allowance or give any credit for charges that result from unauthorized access.

To minimize the risk of unauthorized access to your communications system:

- Use a nonpublished Remote Access number.

- Assign access codes randomly to users on a need-to-have basis, keeping a log of *all* authorized users and assigning one code to one person.
- Use random-sequence access codes, which are less likely to be easily broken.
- Deactivate all unassigned codes promptly.
- Ensure that Remote Access users are aware of their responsibility to keep the telephone number and any access codes secure.
- When possible, restrict the off-network capability of off-premises callers, using calling restrictions, Facility Restriction Levels, and Disallowed List capabilities.
- When possible, block out-of-hours calling.
- Frequently monitor system call detail reports for quicker detection of any unauthorized or abnormal calling patterns.
- Limit Remote Call Forwarding to persons on a need-to-have basis.

Limited Warranty and Limitation of Liability

AT&T warrants to you, the customer, that your MERLIN LEGEND Communications System will be in good working order on the date AT&T or its authorized reseller delivers or installs the system, whichever is later ("Warranty Date"). If you notify AT&T or its authorized reseller within one year of the Warranty Date that your system is not in good working order, AT&T will without charge to you repair or replace, at its option, the system components that are not in good working order. Repair or replacement parts may be new or refurbished and will be provided on an exchange basis. If AT&T determines that your system cannot be repaired or replaced, AT&T will remove the system and, at your option, refund the purchase price of your system, or apply the purchase price towards the purchase of another AT&T system.

If you purchased your system directly from AT&T, AT&T will perform warranty repair in accordance with the terms and conditions of the specific type of AT&T maintenance coverage you selected. If you purchased your system from an AT&T-authorized reseller, contact your reseller for the details of the maintenance plan applicable to your system.

This AT&T limited warranty covers damage to the system caused by power surges, including power surges due to lightning.

The following will not be deemed to impair the good working order of the system, and AT&T will not be responsible under the limited warranty for damages resulting from:

Customer Support Information

- Failure to follow AT&T's installation, operation, or maintenance instructions
- Unauthorized system modification, movement, or alteration
- Unauthorized use of common carrier communication services accessed through the system
- Abuse, misuse, or negligent acts or omissions of the customer and persons under the customer's control
- Acts of third parties and acts of God

AT&T'S OBLIGATION TO REPAIR, REPLACE, OR REFUND AS SET FORTH ABOVE IS YOUR EXCLUSIVE REMEDY.

EXCEPT AS SPECIFICALLY SET FORTH ABOVE, AT&T, ITS AFFILIATES, SUPPLIERS, AND AUTHORIZED RESELLERS MAKE NO WARRANTIES, EXPRESS OR IMPLIED, AND SPECIFICALLY DISCLAIM ANY WARRANTIES OF MERCHANTABILITY OR FITNESS FOR A PARTICULAR PURPOSE.

Limitation of Liability

EXCEPT FOR PERSONAL INJURY, DIRECT DAMAGES TO TANGIBLE PERSONAL PROPERTY PROXIMATELY CAUSED BY AT&T, AND LIABILITY OTHERWISE EXPRESSLY ASSUMED IN A WRITTEN AGREEMENT SIGNED BY AT&T, THE LIABILITY OF AT&T, ITS AFFILIATES, SUPPLIERS, AND AUTHORIZED RESELLERS FOR ANY CLAIMS, LOSSES, DAMAGES, OR EXPENSES FROM ANY CAUSE WHATSOEVER (INCLUDING ACTS OR OMISSIONS OF THIRD PARTIES), REGARDLESS OF THE FORM OF ACTION, WHETHER IN CONTRACT, TORT OR OTHERWISE, SHALL NOT EXCEED AN AMOUNT EQUAL TO THE LESSER OF THE DIRECT DAMAGES PROVEN OR THE PURCHASE PRICE OF THE SYSTEM. IN NO EVENT SHALL AT&T OR ITS AFFILIATES, SUPPLIERS, OR AUTHORIZED RESELLERS BE LIABLE FOR INCIDENTAL, RELIANCE, CONSEQUENTLY, OR ANY OTHER INDIRECT LOSS OR DAMAGE (INCLUDING LOST PROFITS OR REVENUES) INCURRED IN CONNECTION WITH THE SYSTEM. THIS LIMITATION OF LIABILITY SHALL SURVIVE FAILURE OF THE EXCLUSIVE REMEDY SET FORTH IN THE LIMITED WARRANTY ABOVE.

Voice Mail Systems

Your voice mail system permits callers to leave verbal messages for system users or gain access to the backup position in an emergency as well as create and distribute voice messages among system users.

The voice mail system, through proper administration, can help you reduce the risk of unauthorized persons gaining access to the network. However, phone numbers and authorization codes can be compromised when overheard in a public location, are lost through theft of a wallet or purse containing access information, or through carelessness (writing codes on a piece of paper and improperly discarding them). Additionally, hackers may use a computer to dial an access code and then publish the information to other hackers. Substantial charges can accumulate quickly. It is your responsibility to take appropriate steps to implement the features properly, evaluate and administer the various restriction levels, protect and carefully distribute access codes.

Under applicable tariffs, you will be responsible for payment of toll charges. AT&T cannot be responsible for such charges and will not make any allowance or give any credit resulting from unauthorized access.

To reduce the risk of unauthorized access through your voice mail system, please observe the following procedures:

- Employees who have voice mailboxes should be required to use the passwords to protect their mailboxes.
 - Have them use random sequence passwords.
 - Impress upon them the importance of keeping their passwords a secret.
 - Encourage them to change their passwords regularly.
- The administrator should remove any unneeded voice mailboxes from the system immediately.
- AUDIX Voice Power has the ability to limit transfers to subscribers only. You are strongly urged to limit transfers in this manner.
- Use the Hybrid/PBX or Key system administration capability to do the following:
 - Block direct access to outgoing lines and force the use of account codes/authorization codes.
 - Disallow trunk-to-trunk transfer unless required.
 - Assign toll restriction levels to all AUDIX Voice Power ports or other voice mail ports.
 - If you do not need to use the Outcalling feature, completely restrict the outward calling capability of the AUDIX Voice Power ports. Use voice mail application features to do this.
- Monitor SMDR reports or Call Accounting System reports for outgoing calls that might be originated by AUDIX Voice Power ports or other voice mail ports.

Remote Administration and Maintenance

The Remote Administration and Maintenance feature of your telecommunications system, if you choose to use it, permits users to change the system features and capabilities from a remote location.

The Remote Administration and Maintenance feature, through proper administration, can help you reduce the risk of unauthorized persons gaining access to the network. However, telephone numbers and access codes can be compromised when overheard in a public location, are lost through theft of a wallet or purse containing access information, or through carelessness (for example, writing codes on a piece of paper and improperly discarding them). Additionally, hackers may use a computer to dial an access code and then publish the information to other hackers. Substantial charges can accumulate quickly. It is your responsibility to take appropriate steps to implement the features properly, evaluate and administer the various restriction levels, and protect and carefully distribute access codes.

Under applicable tariffs, you will be responsible for payment of toll charges. AT&T cannot be responsible for such charges and will not make any allowance or give any credit resulting from unauthorized access.

To reduce the risk of unauthorized access through Remote Administration and Maintenance, please observe the following procedures:

- The System Administration and Maintenance capability of a Hybrid/PBX or Key system is protected by a password.
 - Change the default password immediately.
 - Continue to change the password regularly.
 - Only give the password to people who need it and impress upon them the need to keep it secret.
 - If anyone who knows the password leaves the company, change the password immediately.
- If you have a special telephone line connected to your Hybrid/PBX or Key system for Remote Administration and Maintenance, you should do one of the following:
 - Unplug the line when it is not being used.
 - Install a switch in the line to turn it off when it is not being used.
 - Keep the Remote Administration and Maintenance telephone number secret. Only give it to people who need to know it, and impress upon them the need to keep it a secret. Do not write the telephone number on the Hybrid/PBX or Key system, the connecting equipment, or anywhere else in the system room.

Customer Support Information

- If your Remote Administration and Maintenance feature requires that someone in your office transfer the caller to the Remote Administration and Maintenance extension, you should impress upon your employees the importance of only transferring authorized individuals to that extension.

Abbreviations

A

AC
Automatic Callback

ACP
All-Call Privacy

AR
Automatic Recall

ARs
Automatic Route Selection

ATL telephone
Analog Multiline telephone

AVP
Integrated Solution Audix Voice Power

B

B-channel
bearer channel

B N
billing number

BRI
Basic Rate Interface

C

CO
central office

COBOT
Automated Attendant

COBOTYX
AT&T Attendant

CO-BRI
Central Office-Basic Rate Interface

COT
Customer Originated Trace

C P N
calling party number

D

D-channel
data channel

DGC
Direct Group Calling

DLC
Direct Line Console

D N
Directory Number

DPT
Direct Pool Termination

D S E
digital switching element

D S L
Digital Subscriber Line

F

FEBE
Far-End Block Error

I

ICOM button
intercom button

ISDN
Integrated Services Digital Network

L

LASS
Local Area Signaling Service

L E D
light-emitting diode

Abbreviations

M

- M F M**
Multi-Function Module
- M L H G**
Multi-Line Hunt Group
- M L P P**
Multi-Level Precedence and Preemption
- MLX telephone**
Multiline Digital telephone
- M O H**
Music-On-Hold
-

N

- N E B E**
Near-End Block Error
- NTSC**
National Technical Service Center
-

P

- PBX**
Private Branch Exchange
- P C P**
Per-Call Privacy
- P R I**
Primary Rate Interface
-

Q

- QCC**
Queued Call Console
-

R

- RAM**
Random-Access Memory
- ROM**
Read-Only Memory
-

S

- SA button**
System Access button
- S I D**
Station Identification
- SMDR**
Station Message Detail Recording
- SPID**
Service Profile Identifier
- S P M**
System Programming and Maintenance
-

T

- TDM**
time-division multiplex
-

U

- UPAM**
Universal Paging Access Module
- USOP**
User Service Order Profile
-

V

- VMI**
Voice Messaging Interface
-

Glossary

A

adjunct

Optional equipment used with the communications system, such as an alerting device that connects to a multiline telephone or to a telephone jack.

analog transmission

A mode of transmission in which information is represented in continuously variable physical quantities such as amplitude, frequency, phase, or resistance. See also digital transmission,

application

Software and/or hardware that adds functional capabilities to the communications system, For example, the Call Management System (CMS) is a DOS-based application that simulates the actions of a system operator by answering calls and distributing them to individual telephones.

Automatic Route Selection (ARS)

Routes calls over outside trunks according to the number dialed and the trunks available,

B

B-channel

A 64-kbps channel that carries a variety of digital information streams, such as voice at 64 kbps, data at up to 64 kbps, wideband voice encoded at 64 kbps, and voice at less than 64 kbps, alone or combined with other digital information streams. Also called *bearer channel*.

Behind Switch mode

A mode of operation in which the communications system control unit is connected to (is "behind") another communications system.

billing number (BN)

A number provided by the central office and is used for billing information.

button

A key on the face of a telephone or console that is used to access a line, activate a feature, or enter a code on a communications system,

C

calling group

A team of agents who answer the same types of calls.

calling party number (CPN)

A number that identifies the originator of a call and is provided either by the originating customer premises equipment or by the originating central office.

Calling Party Number/Billing Number (CPN/BN)

A BRI feature in which the number of the originator of an outside call is transmitted over a BRI line to the MERLIN LEGEND system. Each incoming call to the system over a BRI line can be the CPN/BN of the calling party.

channel

A telecommunications transmission path for voice and/or data.

communications system

A communications system that provides voice and/or data communications services, including access to public and private networks, for telephones and data terminals on a customer's premises.

control unit

The housing, carriers, power supply, processor, and modules of a communications system,

D

D-channel

A D-channel (data channel) monitors and controls B-channel communication and initializes ISDN lines. It conveys the signaling that sets up, maintains, and clears calls. Each D-channel has a capacity of 16 Kbps.

dial-out code

A code (usually a 9) dialed by telephone users with System Access buttons to get an outside line.

digital

The representation of information in discrete elements such as *off* and *on* or 0 and 1. See *a/so* analog transmission

Digital Subscriber Line (DSL)

An ISDN Basic Rate, 2-wire U-interface between the 5ESS central office and the MERLIN LEGEND system. The term "Digital Subscriber Line" is used synonymously with the term "BRI line." Each DSL consists of two 64-Kbps B-channels and one 16-Kbps D-channel. The MERLIN LEGEND system supports two Directory Numbers for each DSL.

digital transmission

A mode of transmission in which the information to be transmitted is first converted to digital form and then transmitted as a serial stream of pulses. See *also* analog transmission

Direct-Line Console (DLC)

An answering position used by system operators to answer calls, transfer calls, make calls, set up conference calls, and monitor system operations. Calls can ring on any of the line buttons, and several calls can ring simultaneously (unlike the QCC where calls are sent to a common QCC queue and wait until a QCC is available to receive a call).

Directory Number (DN)

Usually the Directory Number is the number that was dialed to reach the destination. However, sometimes the CO may change the number to make routing easier. In either case, when an incoming call arrives at a MERLIN LEGEND system, the CO presents the DN to the MERLIN LEGEND system,

F

factory setting

The default state of a device or feature if the user does not choose an optional setting.

feature

A function or service provided by a hardware or software product,

feature code

A code entered on a dialpad to activate a feature. For example, to use Last Number Dial, a user presses the Feature button and dials 84. When not using the Feature, the user dials #84,

feature screen

A display screen on digital display telephones that provides quick access to commonly used features.

H

home screen

The "home base" of the display screen on digital telephones, which shows time, date and call information, and when a feature is in use,

Hybrid/PBX mode

A mode of operation in which the communications system uses trunk pools and Automatic Route Selection (ARS). The Hybrid/PBX mode also provides a single interface to users for both internal and external calling.

I

Inside dial tone

A tone users hear when they are connected to an intercom line.

J

jack

A device, accessed by inserting a plug, that is used to terminate the permanent wiring of a circuit,

K

Key mode

A mode of operation in which the communications system uses direct facility terminations on line buttons with a separate path for internal calling.

L

light-emitting diode (LED)

A semiconductor device that produces light when voltage is applied. LEDs show the operational status of hardware components, the results of maintenance tests, the alarm status of circuit packs, and the activation of telephone features.

lines

Lines are the representations that appear on MERLIN LEGEND telephones. They are used to place and receive calls and can be put into pools. Except for the 800 CO-BRI and the 100D modules, all line modules have a one-to-one correspondence between lines and ports. On the 800 CO-BRI module, 8 ports provide 16 B-channels for transmission. In the MERLIN LEGEND system each B-channel is mapped to a line with a separate dial plan number. Therefore, each 800 CO-BRI module is assigned 16 lines.

line numbering

A numbering sequence used to identify station and trunk locations on the communications system control unit.

M

module

A module in the control unit provides the capability to connect telephone company trunks and/or telephones to the system,

Music-on-Hold

A customer-provided music source or Magic on Hold connected to the communications system via a loop-start (LS) jack. Most Music-on-Hold equipment is designed for LS operation,

N

network

A configuration of communications devices and software connected for information interchange.

network interface

Hardware, software, or both that links two systems in an interconnected group of systems, for example, between the local telephone company and a PBX.

P

personal line

A telephone company line that rings only at the user's telephone.

pool

On a Hybrid/PBX system, a grouping of outside trunks that users can choose with multiple pool buttons or by dialing access codes on a System Access button on the telephone. Pools are also used by the Automatic Route Selection (ARS) feature to choose the least expensive method to route a call.

port

A point of access into a communications system, computer, network, or other electronic device.

Primary Rate Interface (PRI)

A standard interface that specifies the protocol used between two or more communications systems. PRI runs at 1,544 Mbps and, as used in North America, provides twenty-three 64-kbps B-channels (voice or data) and one 64-kbps D-channel (signaling). The D-channel is the 24th channel of the interface and contains multiplexed signaling information for the other 23 channels.

Q

Queued Call Console (QCC)

An answering position available to MLX-20L telephone users only in the Hybrid/PBX mode. The QCC is used by system operators to answer and direct (transfer) calls, serve as a message center, and monitor system operation. Calls are sent to a common QCC queue where they wait until a QCC is available to receive a call (unlike the DLC where calls can ring on any of the line buttons, and several calls can ring simultaneously).

S

Service Profile Identifier (SPID)

A Service Profile Identifier associates a terminal with a User Service Order Profile (see below) that contains the information necessary to provide service to the terminal. At the time of subscription, the network provides each SPID. A station's Directory Number is usually a subset of the SPID. *Compare to* User Service Order Profile.

signaling

The sending of control and status information between devices to set up, maintain, or take down a connection.

single-line telephone

An industry-standard touch-tone or rotary telephone that only handles one trunk and is connected to the communications system via a jack on a basic telephone module.

special character

A pause, stop, or end-of-dialing signal in a programmed dialing sequence such as an Auto Dial or Personal Speed Dial number.

station

The endpoint on the internal side of the communications system. A station can be a telephone with or without an adjunct or can be a data terminal with a modem (analog) or a 7500B Data Module (digital) attached.

station jack

An analog, digital, or tip/ring interface on the control unit module for connecting telephones and other equipment.

Station Message Detail Recording (SMDR)

Captures detailed usage information on incoming and outgoing voice and data calls.

Station Message Detail Recording printer

A printer used for Station Message Detail Recording (SMDR) that is connected to the communications system via an RS-232 jack on the processor.

switchhook flash

Operation of the telephone switchhook in which the on-hook period is in the range of 250-500 ms.

system renumbering

A process used to change the extension numbers assigned to telephones, adjuncts, Calling Groups, Paging Groups, Call Park Zones, Remote Access, and lines/trunks.

System Programming and Maintenance (SPM)

A DOS- or UNIX-based application for programming and maintaining the communications system.

T

tie trunk

A private line directly connecting two communications systems.

tip/ring

The contacts and associated conductors of a single-line telephone plug or jack.

trunk jack

A jack that connects an outside trunk to the communications system control unit.

U

User Service Order Profile (USOP)

A User Service Order Profile contains the service configuration for a BRI line (or lines). It is configured by the 5ESS central office when BRI lines are ordered.

Index

#

- 100D module
 - clock source programming, 5-5—5-7
 - local clock source, as, 6-13
 - maximum number of, 2-3
- 5ESS central office (CO)
 - BRI connection, 1-4
 - outgoing calls, 1-11
 - feature interaction with, 1-12—1-13
- 5ESS Generic 8 Custom (5E8) software, 1-4
- 800 CO-BRI module
 - B channel testing, 6-10
 - clock synchronization, setting, 6-13
 - description, 1-5, 2-2—2-3
 - installation, 2-7—2-8
 - surrogate mode, programming, 5-2
 - wiring, 2-6

A

- accessing Maintenance Screens, 6-3
- adjuncts, unsupported, 2-14
- alarms, 2-5, 6-2, 6-18
- All-Call Privacy
 - activated, 3-3
 - considerations and constraints, 3-4
 - description, 1-14, 3-2
 - feature interactions, 3-5
 - mode differences, 3-5
 - not activated, 3-4
- analog multiline telephones, 1-7, 2-13
- applications, supported, 2-15
- AT&T Attendant (COBOTYX), 1-8, 2-15
- AT&T FAX Attendant (FA), 1-9
- AUDIX Voice Power (AVP), 1-8, 1-9
- Automated Attendant (COBOT), 2-15
- Automatic Callback feature
 - considerations and constraints, 3-8
 - description, 1-15, 3-6
 - feature interactions, 3-9
 - feature use, 3-6, 3-7

- mode differences, 3-8
 - telephone differences, 3-8
- Automatic Recall feature
- considerations and constraints, 3-12
 - description, 1-15, 3-10
 - feature interactions, 3-12
 - feature use, 3-10
 - mode differences, 3-12
 - telephone differences, 3-12
- Automatic Route Selection (ARS), 1-10, 1-11

B

- B-Channel Loopback test, 6-2, 6-4, 6-10-6-15
- B-channels, 1-3, 2-3
- Basic Rate Interface (BRI) lines, see BRI lines
- bearer channels, 1-3
- Board Controller test, 6-2, 6-4, 6-7-6-10
- Boot ROM Failure, 6-7
- BRI Access button
 - applications unsupported, 2-15
 - Automatic Callback, 3-7, 3-8
 - Automatic Recall, 3-11
 - CO Transfer, 2-15
 - description, 1-7
 - Hybrid/PBX mode, with, 1-10
 - programming, 5-2, 5-14-5-18
- BRI Information report, 5-19
- BRI lines
 - error messages, 6-22
 - factory settings, 5-12
 - ordering, 1-4
 - overview, 1-6
 - pools, using, 1-10
 - programming procedure, 5-12-5-16
 - SPID assigning, 4-8, 4-9
 - type of service, 1-5
- BRI LOSS OF SYNC, 6-14
- BRI module, see 800 CO-BRI module
- BRI NET DEACTIVATE message, defined, 6-14
- BRI SLIPS > 88 message, defined, 6-14

C

Call Accounting System (CAS), 1-8
 Call Accounting Terminal (CAT), 1-8
 Call Handling, 1-11-1-14
 Call Management System (CMS), 1-8
 calling groups, 1-11, 5-2
 Calling Party Number/Billing Number
 analog sets with, 2-13
 description, 1-14, 3-13
 Centralized Telephone Programming, 1-7, 5-2, 5-14
 clock status, monitoring, 6-2, 6-15
 clock synchronization
 planning considerations, 4-10
 planning form instructions, 4-11
 programming procedure, 5-8-5-12
 setting clock source, 6-13-6-16
CO Transfer feature
 BRI Access button, using, 1-7, 5-14
 considerations and constraints, 3-16
 description, 1-15, 3-15
 feature interactions, 3-18
 feature use, 3-15
 mode differences, 3-17
 telephone differences, 3-17
 Conference, feature, using 1-12
 Control unit
 line capacity, 4-4
 mode of operation, 4-5
 module placement, 4-4
 planning, 4-4-4-7
 Conversant Voice Information Systems (CVIS) INTRO,
 1-8
 Convert feature, using, 2-15
 Customer Originated Trace, 3-13-3-20
 considerations and constraints, 3-21
 description, 1-16, 3-21
 feature interactions, 3-22
 mode differences, 3-21
 telephone differences, 3-22

D

D-channel, 1-3, 2-3
 data channel, BRI, 1-3
 demand tests, 6-2

Digital Subscriber Line (DSL)
 defined, 1-6, 2-3
 error events, 6-2, 6-17
 monitoring, 6-16, 6-19
 Ports, 5-6, 6-13-6-14
 port as clock source, 5-6
 Direct Line Consoles (DLCs), 1-10
 Direct Pool Termination buttons, 1-11
 Directory Number (DN), 1-4, 1-6, 1-10, 5-3, 5-14
 Drop button, removing errors with, 6-18
 DS1, see 100D module
 DSL, see Digital Subscriber Line
 Dual Port RAM Failure message, 6-7

E

error events, 6-16
 Error Log Report, 5-19
 error logs, 6-2, 6-18
 error messages
 Central Office-Induced Errors, 6-20
 Endpoint errors, 6-22
 Endpoint establishment failed, 6-22
 Endpoint is in RESTRICTED mode, 6-22
 Far-End Block (CRC) errors, 6-23
 Loss of Synchronization, 6-19
 minor errors, 6-23
 Near-End Block (CRC) errors, 6-23
 Network Deactivation, 6-20
 Network Invoked 2B+D Loopback
 Activation, 6-20
 Network Invoked B1 Loopback Activation, 6-21
 Network Invoked B2 Loopback Activation, 6-21
 Network Invoked Insertion Loss Loopback
 Activation, 6-21
 Network Invoked Quiet Mode Loopback
 Activation, 6-21
 Network not responding to a RELease, 6-22
 Network not responding to a SETUP, 6-22
 Network Requested Corrupted CRCs, 6-20
 Network took endpoint out of service, 6-22
 SETUP and RELease Message errors, 6-22
 slips, 6-20
 synchronization errors, 6-19
 Extension Copy feature, 5-14
 Extension Information report, 5-19

F

feature access code, 1-15
feature code, single line telephones with, 2-13
feature interaction, 3-5, 3-9, 3-18
Feature module
 description, 1-4
 installation, 2-9-2-11
 requirements, 2-2
features, BRI, see also specific feature names
 All-Call Privacy, 1-14, 3-2—3-5
 Automatic Call, 1-15, 3-6-3-9
 Automatic Recall, 1-15, 3-10-3-12
 BRI Access button, 1-7, 2-15
 Calling Party Number/Billing Number (CPN/BN),
 1-14, 3-13—3-14
 CO Transfer, 1-15, 3-1 5—3-18
 Customer Originated Trace, 1-16, 3-21—3-22
 LASS, 1-15—1-16
 MLPP, 1-16, 3-23—3-24
 Trunk-to-Trunk Transfer, 1-12
features, MERLIN LEGEND
 Allowed List, 3-18
 Auto Dial, 3-5, 3-9, 3-12, 3-22, 3-24
 Barge-In, 3-18
 Call Handling, 1-11
 Calling Restrictions, 3-18
 Conference, 1-12, 3-18
 Coverage, 3-18
 Disallowed List, 3-18
 Direct Line Console, 3-18
 Directory, 3-5, 3-9, 3-12, 3-18, 3-22, 3-24
 Hold, 1-11, 3-19
 Park, 3-19
 Pick, 3-19
 QCC, 3-19
 Recall, 1-13, 3-19
 Remote Access, 1-13
 Speed Dial, 3-5, 3-9, 3-12,3-22,3-24
 Transfer, 1-12
FEBEs, 6-23
Flash ROM Failure, 6-7
frame slip counters, 6-14

G

General Trunk Information report, 5-19

H

HackerTracker system, 1-8
HDLC Failure, 6-7
Hybrid/PBX mode
 compatibilities, 1-10
 planning considerations, 4-5
 QCC operator, with 4-7

I

Incoming Calls, use with BRI, 1-11
Integrated Administration, supported, 1-9
Integrated Services Digital Network (ISDN), 1-2, 1-3
Integrated Solution AUDIX Voice Power (AVP), 2-15
Integrated Solution 11, supported, 1-8
Integrated Solution III, 1-9
Integrated Voice Power Automated Attendant, 1-8
Intercom call with Transfer feature, 1-12
Internal (DSE) Loopback test, 6-2, 6-4, 6-5—6-8
Internal Loopback Test Procedure, 6-5

J

Jacks, auxiliary equipment, planning, 4-7
Jacks, outside lines, planning, 4-6

K

Key mode, with BRI lines, 1-10, 4-5

L

light-emitting diode (LED), 1-11, 2-5
 line capacity, planning considerations, 4-4
 line connections
 jacks for auxiliary equipment, 4-7
 jacks for outside lines, 4-6
 line jack types, 4-6
 planning, 4-6-4-7
 line jack types, planning, 4-6
 line mapping, 1-6
 line number, 5-19
 line options planning
 clock synchronization, 4-10
 Pools, 4-8
 QCC operator to receive calls, 4-7
 QCC queue priority, 4-8
 Remote Access, 4-8
 Service Profile Identifier (SPID), assigning, 4-8
 timers, 4-12
 Local Area Signaling Services (LASS) features, 1-11, 5-14
 local clock, setting, 6-14
 loop clock source, 6-14
 loop source, 5-6, 6-13
 loss of a frame error, 6-20
 Loudspeaker paging, unsupported 2-14

M

maintenance alarm, 2-14, 5-2
 maintenance software, 6-14
 maintenance tests, 6-18
 MERLIN Identifier, 1-9
 MERLIN LEGEND Call Accounting System (CAS), 1-8
 MERLIN LEGEND Integrated Solution Call Accounting System (CAS), 1-9
 MERLIN LEGEND Transfer feature, 1-12
 MERLIN MAIL Voice Messaging System, 1-9, 2-15
 MERLIN MAIL-Multi-Lingual Release, 1-9
 MLX telephones, 1-7, 1-14
 MLX-20L telephone, 5-1
 module, see 800 CO-BRI module

National Technical Service Center, 6-24
 NEBEs, appearance of, 6-23
 network interface, 2-6

O

Octel Voice Messaging Systems, 2-15
 Ordering BRI Lines, 1-4
 Outgoing Calls, 1-11

P

paging, 5-2
 PassageWay software, 1-9, 2-15
 Per-Call Privacy, 1-14, 3-2-3-5
 considerations and constraints, 3-4
 description, 3-2
 feature interactions, 3-5
 feature use, 3-3—3-4
 mode differences, 3-5
 permanent error log, 6-18
 permanent errors, 6-18
 personal computer (PC), 5-1
 personal line buttons, 1-11
 personal lines, 1-10, 5-2
 PictureTel 4000, supported 1-9
 pin assignments, 2-6

planning forms
 System Form 3e, Outside Lines—BRI Options, 5-3, 5-7, 5-11
 System Form 4b, Analog Multiline Telephones, 5-15
 System Form 4b, Digital/ISDN Telephone, 5-15
 System Form 5a, Direct-Line Console (DLC)—Analog, 5-15
 System Form 5b, Direct-Line Console (DLC)—Digital/ISDN, 5-15
 Point-to-Multipoint service, 1-5
 pool access codes, 1-11
 Pool button, 1-10
 Pool dialout code, 1-10
 pools
 description of, 1-10
 planning considerations, 4-8
 programming considerations, 5-2
 port screens, 6-1 5—6-1 9
 PRI (see primary rate interface)
 primary clock source, 6-13
 primary loop clock source, 5-6
 Primary Rate Interface (PRI), 1-3, 1-11
 Print option, 5-19
 private network, 1-16
 Processor module, 1-4, 6-10, 6-13

Q

QCC operator to receive calls
 planning considerations, 4-7
 QCC queue priority, planning considerations, 4-8
 Queued Call Consoles (QCCs), 1-10, 1-11, 5-14

R

RAM Failure, 6-7
 Recall feature, using, 1-13, 3-19
 Remove Access feature, 4-8
 Reset feature, 6-4

S

secondary clock source, 6-13
 Secure Telephone Unit III (STU III), 2-13
 Service Profile Identifier (SPID)
 errors, tracking, 6-18
 planning considerations, 4-8
 planning form instructions, 4-9
 programming procedure, 5-4—5-8
 Service Profile Identifiers (SPIDs), 1-4
 single-line telephone, 2-13, 5-14
 Slot menu, 6-15
 Slot Status screen, 6-2
 surrogate mode, programming, 5-2
 System Access button, 1-10, 1-11
 system alarm, 6-18
 system erase, 5-6
 System Inventory screen, 6-2
 System Programming and Maintenance (SPM) utility,
 backing up system software, 2-9
 programming BRI, 5-3—5-5
 upgrading system software, 2-12, 2-15
 System Programming Reports, 5-19
 system restart, 5-6

T

telephones
 assigning buttons, 4-13-4-15
 BRI Access button, using, 1-10
 supported, 2-13
 tertiary clock source, 6-13
 time-division multiplex (TDM) clock reference, 5-6, 6-13
 timers
 description, 5-10
 failure messages, 6-7
 planning considerations, 4-12
 planning form instructions, 4-12
 programming BRI, 5-10—5-13
 system planning, 5-14
 tip/ring ports and stations, 2-13, 5-14
 TDM clock, see time-division multiplex clock
 transceiver failure, 6-7
 transient errors, 6-18
 Trunk-to-Trunk Transfer feature, 1-12

U

Universal Paging Access Module (UPAM), 2-14
upgrading the MERLIN LEGEND System, 2-9
User Service Order Profile (USOP), 1-4, 1-10, 5-3

V

Vistium Personal Video system 1200/1300,
supported, 1-9
Voice Messaging Interface (VMI) ports, 2-15

W

wiring, 800 CO-BRI Module, 2-6

555-601-111
October 1994

Graphics @AT&T 1988

