



MERLIN LEGEND[®] Communications System Releases 3.1 and 4.0

MLX-10D[®], MLX-10DP[™], MLX-16DP[™], MLX-28D[®], and
MLX-20L[®] Display Telephones User's Guide

Contents

Your MERLIN LEGEND MLX Display Telephone	1
Describes the phone buttons and screens	
Understanding Your Telephone	2
Line Buttons, Line Button Lights, Tones, Rings	
Feature Finder	3-4
Use to choose the right feature for the activity you want to perform.	
Headsets	5
Headpieces, Headset Features	
Call Handling	6
Making & Answering Calls, Transfer, Hold, Conference	
Messaging	7-8
Leaving Messages, Receiving Messages	7
Posting Messages, Signaling & Notify	8
Using Features	9
Display-Only Features, Other Features, Feature Codes	
Often-Used Features	10-18
Account Codes, Alarm Clock & Timer	10
Authorization Codes, Auto Dial	11
Callback & Line Request, Call Waiting, Camp-On	12
Coverage, Direct Voice Mail	13
Directories: Extension & System Directory, Personal Directory	14
Do Not Disturb, Forward & Follow Me, Last Number Dial	15
Night Service, Paging, Park & Pickup	16
Personal Speed Dial, Privacy, Pickup	17
Saved Number Dial, Special Characters, System Speed Dial, Voice Announce	18
Display Reference	19-20
Display Screens	19
Abbreviations Used on Phones with 2-Line Displays	20
Programming Buttons & Settings	20-21
Display Programming, Code Programming	20
Programming Codes	21



Security Alert

Your Responsibility for Your System's Security

Toll fraud, the unauthorized use of your telecommunications system by an unauthorized party (for example, persons other than your company's employees, agents, subcontractors, or persons working on your company's behalf) can result in substantial additional charges for your telecommunications services. You are responsible for the security of your system. There may be a risk of toll fraud associated with your telecommunications system. Your system administrator should read all installation, instruction, and system administration documents provided with this product to fully understand the features that can introduce the risk of toll fraud and the steps that can be taken to reduce that risk. Lucent Technologies does not warrant that this product is immune from or will prevent unauthorized use of common-carrier telecommunication services or facilities accessed through or connected to it. Lucent Technologies will not be responsible for any charges that result from such unauthorized use.

Your MERLIN LEGEND MLX Display Telephone

DSS Jack (underside) On MLX-20L and MLX-28D telephones is a connection for a Direct Station Selector (DSS) or PassageWay™ Direct Connect Solution or PassageWay Solution.

ADJUNCT Jack (underside) On MLX-10DP and MLX-16DP telephones is a connection for PassageWay™ Direct Connect Solution or PassageWay Solution.

Unlabeled Display Buttons

Press one to select the item next to or above it on the display.

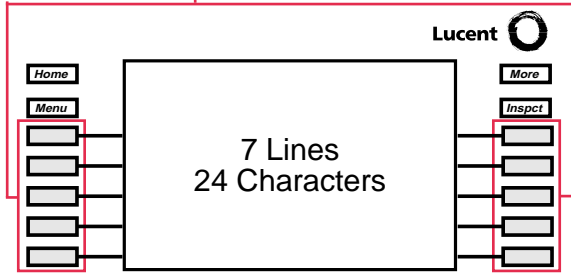

Your Display Screen

Your telephone's display is an alarm clock and timer (see p. 10), telephone directory (see p. 14), and message center (see pp. 7–8). Read the button descriptions on this page to find out how you can use your screen to locate and activate features or see who's calling you. If you have a 2-line display, abbreviations are used on the screen. These are explained in **Display Reference**, pp. 19–20, as are the 4 display screens.

Home

Press to return to the Home screen and exit current activity. Home screen gives calling and timekeeping information, and prompts when you need help.

Volume

Press ∇ or \blacktriangle to change ringer loudness while the phone is ringing, handset volume while you're using the handset, or speaker volume while you're using the speakerphone.

Feature

Press to display Feature screen and select features.

HFAI

(Hands Free Answer on Intercom) Press before calls come in to answer voice-announced calls without lifting the handset.

Mute

Press to turn speakerphone microphone on or off so that you can or cannot be heard by the caller.

User Card Tray

Pull out for quick reference.

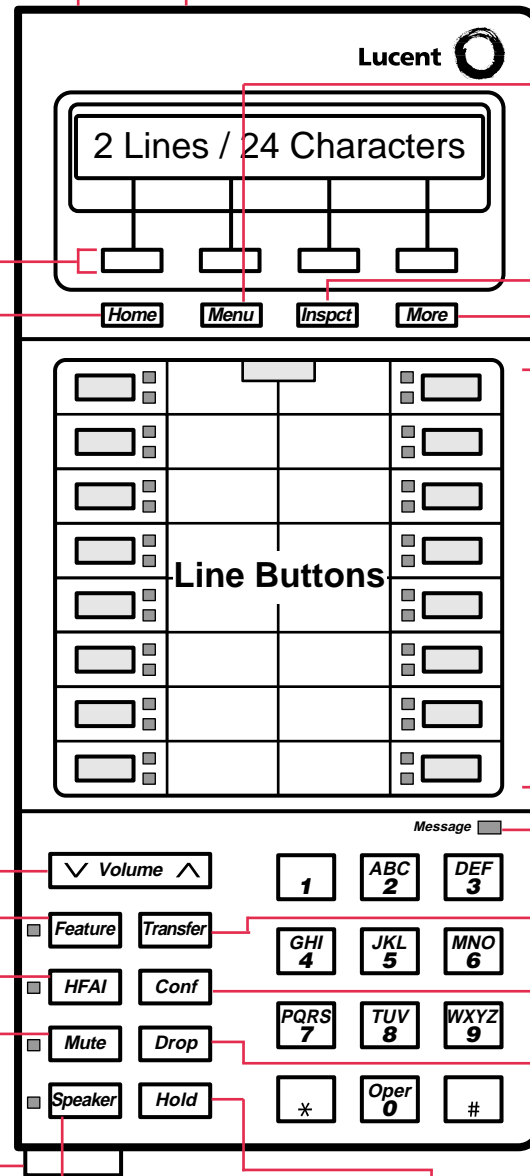

Menu

Press to program the phone, view messages, or select features available only from the display. (See **More** below.)

Inspect

Press **Inspect** and a line button to display information about an incoming or active call or to see what feature is programmed on the button.

More

The > appears on the screen when more information exists. Press **More** to advance through additional menus when necessary or to display more information about an incoming or active call.

Line Buttons

Outside, **Pool**, **SA**, and **ICOM** buttons (see p. 2); blank line buttons can be programmed with features (see p. 20).

- MLX-28D telephone has 28 line buttons.
- MLX-20L telephone has 20 line buttons.
- MLX-16DP telephone (shown) has 16 line buttons.
- MLX-10D telephone and 10DP have 10 line buttons.

Message Light

Indicates a waiting message (see pp. 7–8).

Transfer

Press to send call to another phone (see p. 6).

Conf

Press to add person to a conference (see p. 6).

Drop

Press **Drop** and a line button to disconnect person from a conference call (see p. 6).

Speaker

Press to turn speakerphone on/off for hands-free conversation during a call or when call rings; or press to hang up a speakerphone call.

Hold

Press to put a call on hold (see p. 6).

CAUTION:





To clean your phone, unplug it from the wall jack and use a *slightly* dampened cloth. To prevent permanent damage, do not immerse the phone in water or any liquid, and do not use liquid or aerosol cleaners directly on the telephone.

Understanding Your Telephone







Line Buttons

All Telephones		Telephones with System Access (SA) Buttons	
<i>NNN-XXXX</i>	Make/receive outside calls only.	SA buttons give you access to inside or outside lines for making and/or receiving calls. To make an outside call on an SA button, first dial the dial-out code (usually 9) that your system manager supplies. No dial-out code is necessary when you call another extension.	
Telephones with ICOM Buttons			
ICOM Ring	Make/receive inside ringing calls and receive inside voice-announced calls.	SA Ring	Make/receive inside/outside ringing calls and receive inside voice-announced calls.
ICOM Voice	Make inside voice-announced calls and receive inside ringing and voice-announced calls.	SA Voice	Make/receive outside calls, receive inside ringing and voice-announced calls, make inside voice-announced calls.
ICOM Originate Only	Make (not receive) inside calls only.	SA Originate Only	Make (not receive) inside and outside calls.
		Shared SA (SSA)	Make/answer calls for co-workers or join conversations. One person has an SA button that is shared with one or more others who have SSA buttons corresponding to it. See Rings for information about how calls ring at these buttons.
		Pool	Make/receive outside calls only. Use the dial-out code supplied by your system manager.

Line Button Lights

Light	Meaning
	The line you are using or will use when you lift the handset or press the Speaker button.
	The line is in use, or the feature programmed onto the line button is on.
	An incoming call is ringing on this line button or a call you transferred is returning to this line button (see p. 6).
	You have put a call on hold on this line button.
	Someone else has put a call on hold on this line button.





Tones

Tone	Meaning
	Dial tone (steady) You can make a call.
	Busy (slow repeating tone) The phone you are calling is busy.
	Fast busy (fast repeating tone) No lines are available.
	Error (alternating high-low tones) You dialed a number or used a feature incorrectly.
	Confirmation (double break in dial tone followed by steady tone) You used a feature correctly.
	Callback (5 short beeps) This call is receiving Callback treatment (see p. 12).
	Call Waiting (1 or 2 beeps) You have an inside (1 beep) or an outside (2 beeps) call waiting (see p. 12).

Rings

The table below helps you identify the different types of ringing. You can also personalize ringing at your telephone or adjust ring timing for the line buttons where calls arrive. **Programming Buttons & Settings**, p. 20, tells you how to change the settings. Listed below are your options:

- **Personalized Ring.** Allows you to give calls ringing at your phone one of 8 distinctive rings.
- **Abbreviated Ring.** When you are on a call and another call arrives at your phone, you can use this feature to give the second call a short ring.
- **Immediate Ring.** Calls ring immediately on line buttons set this way.
- **Delay Ring.** This setting causes calls to ring at your phone after a delay. If your calls are being covered, this allows time for another person to answer a call before you do.
- **No Ring.** Calls do not ring (except for returning transferred and Callback calls). Calls on lines set for No Ring do not receive coverage (see p. 13).
- **Send Ring.** Usually, when a call comes in on an **SA** button, it rings there immediately and rings at the corresponding **SSA** buttons after a delay, giving the person with the **SA** button time to answer before the call is picked up by someone with a corresponding **SSA** button. When busy on another call, the person with the **SA** button can use the Send Ring setting to make calls arriving at other **SA** buttons ring *immediately* on corresponding **SSA** buttons instead of after a delay.

Ring	Meaning
	Inside call
	Outside call
	Priority ring; outside call transferred to you or returning camped-on call (see p. 12)
	Returning Callback call (see p. 12)

Feature Finder

This table shows where to look for information about performing specific telephone activities. Any features that do not have detailed instructions can be used by following the directions in **Using Features** (p. 9) or programmed by following the instructions in **Programming Buttons & Settings** (p. 20).

Calling	
If you want to ...	Then
Dial numbers with the touch of a button.	See Auto Dial , p. 11.
Program codes for numbers you dial often (MLX-10D, MLX-10DP, and MLX-16DP telephones).	See Personal Speed Dial , p. 17.
Quickly dial numbers your company has programmed.	See System Speed Dial , p. 18.
Make a voice-announced call to 1 or more co-workers.	See Line Buttons , p. 2, and Paging , p. 16.
Broadcast over the company's loudspeaker system.	See Paging , p. 16.
Make a call after office hours.	See Night Service , p. 16.
Make and answer calls with no hands.	See HFAI button, p. 1, to answer inside calls hands-free. For information about headsets, see p. 5.
Automatically redial a number you dialed before.	See Last Number Dial , p. 15, and Saved Number Dial , p. 18.
Quickly dial numbers from your phone's display.	See Directories , p. 14.
Connect to an extension or outside line when it's free.	See Callback & Line Request , p. 12.
Enter an account code before or during a call.	See Account Codes , p. 10.
Make a call from another extension, using your own calling privileges.	See Authorization Codes , p. 11.
Set up a conference with as many as 4 others.	See Conference , p. 6.
Transfer a call.	See Transfer , p. 6, and Park & Pickup , p. 16.
Know if someone is calling you when all your other lines are in use.	See Call Waiting , p. 12.
Reach a voice mailbox without calling the person.	See Direct Voice Mail , p. 13.
Put a call on hold.	See Hold , p. 6.
Customizing Your Phone	
Program a feature on an unused line button.	See Programming Buttons & Settings , p. 20.
Adjust volume of the speaker, handset, or ringer.	Use the Volume button, p. 1.
Give your phone its own distinctive ring.	See Rings , p. 2.
Delay or remove the ring from an outside, SA , or ICOM line button.	See Rings , p. 2, and Coverage , p. 13.
Change your phone's display language.	Use the Language feature. See Using Features , p. 9.

Feature Finder

Covering Calls	
If you want to ...	Then
Have a co-worker answer your calls. Answer all of a co-worker's calls from your telephone. Stop your calls from being covered by others.	See Coverage , p. 13 and Line Buttons , p. 2.
Stop your outside calls from going to your company's voice mail system (or send your calls to voice mail).	See Coverage , p. 13.
Forward your calls to another telephone. Answer your calls from another extension.	See Forward & Follow Me , p. 15.
Answer a call ringing at a co-worker's extension. Answer a call on a line that's not on your phone.	See Pickup , p. 17.
Put a call on hold at a busy extension until your co-worker is ready for it or complete a transfer to an extension that doesn't answer.	If your phone system doesn't have voice mail, try Camp-On. See p. 12.
Hold a call when you're trying to transfer or when your co-worker doesn't answer; page your co-worker while the call waits.	See Park & Pickup , p. 16.
Messaging	
Let a co-worker know you called. Find out if you have a voice mail message, fax, or other message. Signal a co-worker to contact you. Choose a message to leave for co-workers who have display phones.	See Messaging , pp. 7–8.
Reach a voice mailbox without calling the person.	See Direct Voice Mail , p. 13.
Privacy	
Prevent interruptions by blocking calls to your phone.	See Do Not Disturb , p. 15.
Prevent co-workers from joining your calls.	See Privacy , p. 17.
Prevent others on a call from hearing you speak to someone in your office.	Use the Mute button, p. 1. If you have a headset, use the Headset/Handset Mute feature, p. 5.
See who's calling you while you're on the phone.	Use the Inspect button, p. 1.
Receive or not receive voice-announced calls.	See Voice Announce , p. 18.
Timekeeping	
Remind yourself of meetings or appointments. Time calls or meetings. Change the time, day, or date on display.	See Alarm Clock & Timer , p. 10.

Headsets

Headsets for MLX telephones allow one-touch operation, hands-free. Touch a button to answer a call, then touch it again to disconnect. Headsets consist of a headpiece and modular base unit. The base unit plugs into the handset jack. Use the features below to control headset operation.

A calling group agent using a headset must press the **Headset Hang Up** button to complete a call in order to update the supervisor's **Agent** button.

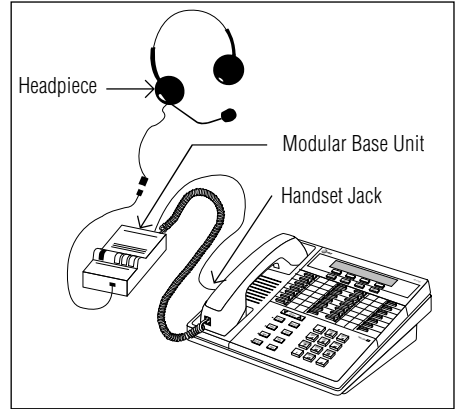

Headpieces

Mirage®. Receiver fits over either ear. Not for noisy environments.

StarSet®. Eartip fits in ear canal.

Supra® Monaural. Adjustable headband and soft ear cushion.

Supra Monaural Noise-Canceling (NC). Same as above with noise-canceling microphone that reduces background noise transmission by up to 75%.

Supra Binaural. Sound in both ears.

Supra Binaural Noise-Canceling (NC). Same as above with noise-canceling microphone on flexible boom; features windscreen and reduces background noise transmission by up to 75%.

Headset Features

To program:

See **Programming Buttons & Settings**, p. 20.

There are 4 features used with headsets: Headset Hang Up, Headset Status, Headset Auto Answer, and Headset/Handset Mute. All must be programmed on buttons. The **Headset Hang Up** button (required) is programmed by your system manager and activates headset operation at your phone.

To use Headset Hang Up:

Press the programmed button to disconnect a call, even if the caller hangs up. Unless you have programmed a **Headset Status** button, headset operation is always on.

To use Headset Status:

Press the programmed button to switch between headset and handset operation; when headset operation is on, the green light is on.

To use Headset Auto Answer:

Connects you automatically to ringing calls during headset operation. When you press the button to activate the feature, the green light goes on; to turn off Headset Auto Answer operation, press the button again.

To use Headset/Handset Mute:

Lets you turn off the microphone in the headset or handset, so that a caller cannot hear your conversation. The red light goes on when the headset (during headset operation) or the handset (during handset operation) microphone is off.

Call Handling

Making & Answering Calls

First, review pp. 1–2 to find out about the buttons, lights, tones, and rings on your telephone. In this guide, instructions for using features may not include all the possible ways you can make a call.

To make a call, lift handset, use a headset, or press the **Speaker** button. The line button with the steady red light is automatically selected for you. To make a call on a specific line (for example, an **SA** or **ICOM Voice** line for a voice-announced call), select an unlit line button and press it before lifting the handset or pressing the **Speaker** button. When using a headset (see p. 5), select a line button first.

To answer a ringing or voice-announced call, lift handset or press the **Speaker** button.

Transfer

To transfer:

1. Press the **Transfer** button. The system selects an **ICOM** or **SA** button and puts the call on hold.
2. Dial the extension or outside number.
3. Announce the call if desired.
4. Press the **Transfer** button or hang up. To cancel the transfer or return to the call on hold, press the flashing **ICOM, SA**, or line button.

To one-touch manual transfer:

1. Press the programmed **Auto Dial** button (p. 11) for the number where you want to transfer the call.
2. Announce the call.
3. Press the **Transfer** button or hang up. To cancel the transfer or return to the call on hold, press the flashing button.

To one-touch auto transfer:

Press the programmed **Auto Dial** button.

Hold

When you have a call or conference on hold, your phone beeps once each minute and the display briefly shows *Call on Hold*.

1. Press the **Hold** button to put a call on hold. (*Do not press the **Drop** button to end a conference while the call is on hold.*)
2. To return to the call or conference, press the flashing **ICOM, SA**, or line button that is holding the call.

Conference

A conference call can have up to 3 inside participants, including yourself, and up to 2 outside participants.

1. Dial the first outside number or extension. Announce the call.
2. Press the **Conf** button to put the call on hold.
3. Select an **ICOM, SA**, or numbered line button.
4. Dial the next number or extension.
5. Announce the call and press the **Conf** button.
6. Repeat Steps 2–5 for each participant.
 - Press the **Drop** button and line button to drop any participant added.
 - Press the **Hold** button to temporarily leave the conference. Then press any participant's line to rejoin the conference.
7. To end the conference, hang up.



SECURITY ALERT:

If the system selects an **SA Voice** button when you add a conference participant, you hear a beep instead of ringing after you dial the extension. If the call is not answered and you press the **Conf** button to complete the call, your conversation with other conference participants is broadcast on the extension's speakerphone. To prevent this, be sure to drop an unanswered extension that you've called on an **SA Voice** button.

Messaging

Your phone system has several features that allow you to leave messages for others in your office. If you use Leave Message or Posted Messages, the person(s) for whom you are leaving a message must have a display phone. If you wish to leave a message for a person who does not have a display telephone, use voice mail and the Direct Voice Mail feature, if available, or ask the system operator to take a message for the person. Here are some guidelines for different messaging features:

- **Leave Message.** This feature simply lets a co-worker know you have called. The message shows your name and the date and time of your call. If you leave one message and then another, the second message replaces the first.
- **Posted Messages.** If you post a message at your telephone, inside callers with display phones see the posted message you have selected. As many as 20 messages may be available for posting.

When a message is waiting for you, your red Message light is lit. The descriptions below explain how to read, cancel, and delete messages you have sent or received.

If your company has voice mail, ask your system manager for details about using the voice mail system. For information about having your phone covered by the voice mail system, see **Coverage**, p. 13.

If you frequently communicate with a small number of people (for example, as a receptionist for a few co-workers), there are two features you can use, both of which require programming a button. These are Signaling and Notify, described on the next page.

Leaving Messages

To program:

See **Programming Buttons & Settings**, p. 20.

To leave a message at a busy or unanswered extension you are calling:

- Press the **Leave Message** button you have programmed,
OR
Press the **Feature** button; then select *Leave Msg [LvMsg]* or dial **25**.
- To leave a voice mail message (if your company has such a system), press the **Feature** button and select *Direct VM [DrcVM]* or dial **56** (see **Direct Voice Mail**, p. 13, for details).

A screen display confirms that the message has been sent, or it alerts you that the message box is full or the message can't be sent (for example, because the called person has no phone display).

To leave a message without calling:

1. Press the **Feature** button and dial **53**.
2. Dial the extension.

To cancel a message:

1. Press the **Feature** button and dial ***53**.
2. Dial the extension.

Receiving Messages

When your red Message light is on, you have a message from a co-worker. Messages are identified by the name or extension of the caller, along with the time and date the person called. Depending on how your system is set up, you may also have a voice mail message or a fax. A message may be identified in these ways:

ATT You have a message from the operator.

FAX You have a fax.

VMS You have a voice mail message.

EXT Indicates the extension number of the person who called.

* Marks a new message.

To read and respond to messages on your display:

1. Press the **Menu** button.
2. Select *Messages [Msgs]*.
3. Choose from:

- *Return Call [Call]* to call your co-worker or voice mail while reading the message.
- *Next Msg [Next]* to see the next message.
- *Delete Msg [Delete]* to delete the message. You can have up to 10 messages; if there are 10, no more are accepted.

Messaging

Posting Messages

A posted message appears on the display of any inside caller who tries to reach you as long as that person has a display phone. (You also see the message posted at your own phone as a reminder.) There may be as many as 20 messages available to you for posting. Message 1 is always *DO NOT DISTURB**; the others may include such choices as: *OUT TO LUNCH*, *OUT SICK*, *IN A MEETING*, depending on how your system manager has programmed them.

To post a message:

1. Press the **Menu** button.
2. Select *Posted Msg [Post]*.
3. Select the message you want to post. Depending upon your phone, you can choose *Next*, *Prev*, or press the **More** button to see more messages.
4. Select *Post*.
5. Press the **Home** button.

To cancel a posted message:

1. Press the **Menu** button.
2. Select *Posted Msg [Post]*.
3. Select *Cancel [Cancel]*.
4. Press the **Home** button.

* If you use the Do Not Disturb feature (p. 15), the appropriate message is posted. When you turn off the Do Not Disturb feature, the posted message is canceled too. However, posting or canceling the message does not activate or deactivate the feature.

Signaling & Notify

To program:

See **Programming Buttons & Settings**, p. 20.

Signaling. Program a button that will cause a co-worker's phone to beep. The other person can then call you in response to the beep. You must program a different line button for each extension you wish to contact. To beep the recipient's phone, just press the button, and the other phone beeps for as long as you hold down the button. A programmed **Signaling** button also acts as an **Auto Dial** button (see p. 11). To dial the extension, lift the handset or press the **Speaker** button; then press the **Signaling** button.

Notify. This feature simply lights a line button on the recipient's phone, providing a silent message light that alerts the other party to call you. To use this feature, you must program a **Notify Send** button (labeled, for example, **Notify Mary**) on your phone and the recipient must program a **Notify Receive** button (labeled, for example, **Call Jim**) on his or her phone. Communication is one-way only, and buttons must be programmed for each extension you notify.

Using Features

There are two ways to activate a feature:

- Directly, as explained below
- By pressing a line button you programmed with the feature (see **Programming Buttons & Settings**, p. 20)

Display-Only Features

To use a Directory of numbers, messages and posted messages, display screen contrast setting (MLX-10D, MLX-10DP, MLX-16DP, and MLX-28D telephones), alarm clock, or timer:

1. Press the **Menu** button.
2. If you see > at the right of the display, there are more options. Press **More** to see them. (Press **More** to use the alarm clock or timer on an MLX-10D, MLX-10DP, MLX-16DP, or MLX-28D telephones.)
3. Respond to display prompts, if necessary.
4. Press the **Home** button to exit at any time.

Other Features

To use a feature from the **Feature Codes** list:

1. Press the **Feature** button.
2. Select the feature from the display, **OR**
Dial the feature code from the **Feature Codes** list.
Note: Some features can only be used by entering a code (see the **Feature Codes** list).
3. Press the **Home** button to exit at any time.

Feature Codes

Account Code Entry	82 + code + #	Messaging	
Authorization Code Entry ●	80 + code + #	cancel message ■	* 53 + extension
Callback	55	leave message	25
Call Waiting		leave message without calling ■	53 + extension
pick up call waiting call ■	87	Paging loudspeaker	9 + line number + zone
Camp-On	57	Personal Speed Dial ■	2-digit code†
Direct Voice Mail ●	56	Pickup	
Follow Me	34 + extension	group	88
Forward		inside	9 + extension
inside	33 + extension	outside	9 + line number
outside	33 + dial-out code + number + #	Privacy	
Forward and Follow Me		off	* 31
cancel from all extensions ■	* 34 *	on	31
cancel from one extension ■	* 34 + extension	Recall	775
cancel from your phone	33 + your extension	Reminders	
Language ▼		set reminder ▼	81 + time + 2 or 7
English	790	cancel reminder	* 81
French	791	System Speed Dial	code (600–729)
Spanish	792		
Last Number Dial	84		

■ Available only by using feature code.

▼ For time functions, English operates on 12-hour clock (2 or 7). French and Spanish operate on 24-hour clock.

● Release 3.0 and later systems only.

† Two-Digit Personal Speed Dial Codes:

01–24 for MLX-10D and MLX-10DP telephones

01–18 for MLX-16DP telephone

Often-Used Features

Account Codes

To program:

See **Programming Buttons & Settings**, p. 20.

In some companies you enter an account code before or during a call to indicate client billing information. You may be *required* to enter an account code for all outside calls, or an account code may be optional for incoming and outgoing calls. Check with your system manager for account code operation and account codes.

You can program a button for this feature and label it **Acct.** See also **Auto Dial**, (p. 11) to program an account code on an outside **Auto Dial** button.

To enter an account code:

1. Press the button you have programmed,
OR
Press the **Feature** button and dial **82 OR** select *Account Code [Acct]* from the display.
2. Dial the account code and **#**.
3. Lift the handset or press the **Speaker** button to make a call. (If necessary, press an outside line, **Pool**, or **SA** button.)
4. Dial the outside number (including dial-out code, if required).

To enter or change an account code during a call (the other party cannot hear your entry), follow Steps 1 and 2. If you enter an account code for an incoming call before it arrives, you cannot change that code during the call.

Alarm Clock & Timer

The Alarm Clock and Timer features are only available from the display and cannot be activated with a feature code. Alarm Clock causes your phone to beep at a certain time; you can set only one alarm. Until canceled, the display shows a bell reminding you that the alarm is on, and the alarm sounds each day at the same time. Timer times calls or other activities for up to 59 minutes, 59 seconds, displaying the elapsed time on your screen. You must turn Timer off when timing is over; it does not turn off automatically at the end of a call.

To set an alarm:

1. Press the **Menu** button.
2. Select *Alarm Clock [AIClk]*.
3. If your display is English, dial a 4-digit time from 0100 to 1259 and select a.m./p.m. to switch between AM and PM.
If your display is French or Spanish, dial a 4-digit code between 0000 to 2359.
If you make an error, select *Reset* and redial.
4. Select *On*.
5. Press the **Home** button. The display shows a bell to remind you that the alarm is on.

To cancel the alarm:

1. Repeat Steps 1 and 2 above.
2. Select *Off*.
3. Press the **Home** button. The display no longer shows a bell.

To time a call or other activity or to turn Timer off:

1. Press the **Menu** button.
2. Select *Timer*.

Often-Used Features

Authorization Codes*

To program:

See **Programming Buttons & Settings**, p. 20.

This feature is useful at companies where there are telephones in public areas that are restricted from making some calls.

If your system manager has given you an authorization code, you can pick up someone else's telephone, enter your authorization code, and make an outside call with your own calling privileges. You must activate the feature and enter your code for each call you make, even when you are adding people to a conference. It is not necessary to use your authorization code for inside calls. Using an authorization code does not affect the button assignments on your own phone or the phone where you enter the code.



Security Alert

Compromise of authorization codes could lead to toll fraud or unauthorized charges.

Memorize your authorization code, and do not share it with anyone.

The way you activate the Authorization Code feature depends upon the type of telephone you are using to make the call.

- *If the telephone has a programmed **Authorization Code** button, press it. The system selects a line and automatically activates the **Speaker** button (an available line button is selected for you); then continue with Step 3 below.*
- *On an MLX display telephone, press the **Feature** button, then select *AuthCode* [*Auth*] from the display or dial **80**; then continue with Step 3 below.*

To enter an authorization code at any type of phone (except a QCC):

1. Lift the handset or press the **Speaker** button. (You may first select an **ICOM, SA, or SSA** button.)
2. Dial **#80**.
3. Dial your authorization code, followed by **#**.
4. Dial the dial-out code (usually a **9**) for an outside call and then dial the phone number.
5. To make another call, repeat Steps 1–4.

* Release 3.0 and later systems only.

Auto Dial

This feature must be programmed on a line button; it dials an inside or outside number. Use inside **Auto Dial** buttons to:

- Dial other extensions or groups.
- Page groups (see **Paging**, p. 16).

Use outside **Auto Dial** buttons to:

- Dial outside phone numbers (with dial-out codes but without account codes).
- Enter account codes automatically (when programming, include **#** at the end).
- Dial long-distance access codes.
- Dial emergency contact numbers.

Note that you can also use other features to automate dialing: Directories (p. 14), Last Number Dial (p. 15), Personal Speed Dial (MLX-10D, MLX-10DP, and MLX-16DP telephones only, p. 17), Saved Number Dial (p. 18), and System Speed Dial (p. 18). When programming Auto Dial, use the **Special Characters** table on p. 18, if necessary. Include the complete dialing sequence for the call.

To program on a button:

1. Label a button.
2. Press the **Menu** button.
3. Select *Ext Program* [*Prog*] and *Start*.
4. Press the button to be programmed.
5. Select *ListFeature* [*List#*] and *Auto Dial* [*AutoD*]. For a paging group, select *List Feature* [*List*] and *Group Page* [*GrpPg*] and go to Step 7.
6. Select *Inside* [*In*] or *Outside* [*Out*] and *Enter*.
7. Dial the group paging number, extension, or outside number and select *Enter*.
8. Repeat Steps 1 and 4–7 to program additional numbers.
9. Press the **Home** button.

*To use an **Auto Dial** button:*

1. To make a ringing call to an inside or outside number, press the programmed **Auto Dial** button, **OR** To make an inside voice-announced call, press an **ICOM Voice** or **SA Voice** button and then press the inside **Auto Dial** button.
2. The call is dialed automatically. If it's a voice-announced call, talk after the beep.

Often-Used Features

Callback & Line Request

Your system has two features that you can use when an outside line or extension is busy. These features give you access to the line or extension when it becomes available.

On phones with **SA** buttons, use Callback to reach:

- Busy outside lines on **Pool** or **SA** buttons, when you dial the dial-out code and hear the fast busy signal.
- Busy extensions, when you dial and hear the busy signal.

On phones with **ICOM** buttons, use:

- Line Request to reach a busy outside line when you lift the handset or press the **Speaker** button and do not hear dial tone.
- Callback for busy extensions.

To use Callback when you hear the busy (extension) or fast busy (outside line) signal:

1. Press the button you have programmed, **OR**
Press the **Feature** button and dial **55**.
2. If you are trying to reach an outside line, dial the outside telephone number.
3. After you hear 5 short beeps, hang up. When the line or extension is free, you hear a long ring and 3 short rings.
4. Lift the handset or press the **Speaker** button. You hear dial tone, and the system dials the call.

To cancel a Callback request:

1. Press the same line button you pressed when you tried to make the call.
2. Lift the handset and press the **Drop** button.
3. Press the same line button again.

To use Line Request:

1. When outside lines are busy, hang up and press the line button you want to use. Do not lift the handset or press the **Speaker** button.
2. When a line is available, the phone beeps. Lift the handset or press the **Speaker** button.
3. Dial the outside number.

Call Waiting

If Call Waiting is on, you hear a call-waiting tone when a call comes in and your lines are in use. This feature works only on **SA** and **ICOM** buttons, not on line buttons labeled with phone numbers.

When a call is waiting, you hear a single beep (inside call) or 2 beeps (outside call).

To complete a call and answer a waiting call:

1. When you hear the call-waiting tone, hang up.
2. When the phone rings, lift the handset or press the **Speaker** button.

To put a call on hold and pick up a waiting call:

1. Press the **Hold** button.
2. Press an **ICOM Originate Only** or **SA Originate Only** button. (You must have one of these buttons available to pick up the call.)
3. Press the **Feature** button and dial **87**.
4. To return to the call on hold, press the button with the fast-flashing green light.

To turn Call Waiting on or off:

1. Press the **Menu** button and select *Ext Program [Prog]*.
2. Select *Start* and press any line button.
3. Select *ListFeature [List#]*.
4. Select *CallWaiting [CWait#]* and then select *On or Off*.
5. Select *Enter* and press the **Home** button to exit programming.

Camp-On

To program:

See **Programming Buttons & Settings**, p. 20.

To camp on a busy extension so the call will ring at the extension when your co-worker is available:

1. Press the **Feature** button.
2. Select *Camp-On [Camp]* from the display **OR**
Dial **57**.

NOTE: Do not use the Camp-On feature if your system is equipped with a voice-mail system.

Often-Used Features

Coverage

To program:

See **Programming Buttons & Settings**, p. 20.

Coverage allows calls to your extension to ring elsewhere, so that they can be handled by someone else. If your system has voice mail, your calls can also be covered that way. There are three types of coverage:

- **Primary Coverage.** If your calls are covered this way, they ring immediately at the covering phone.
- **Secondary Coverage.** The covering phone rings after a delay of 2 rings, giving you a chance to answer first.
- **Group Coverage.** Calls for a group of people (coverage group) may be covered by one or more people. Your system manager can tell you how this works at your office.

Covering phones are programmed with **Cover** buttons used to answer calls for others. Delay Ring on the covering phone can add a longer delay before your calls ring there. If line buttons on your phone are set to No Ring, however, calls on those lines are not covered. (See **Rings**, p. 2.)

To control coverage of inside calls, use these programmable settings: Coverage Inside On allows all your inside calls to ring elsewhere. Coverage Inside Off turns inside coverage off.

You can also program buttons for these Coverage features:

- Use a **Coverage VMS** button to prevent or allow coverage of your outside calls by a voice mail system. These calls may still be covered by a person at another extension.
- Use a **Coverage Off** button to turn off or on all coverage of your calls.

Direct Voice Mail*

To program:

See **Programming Buttons & Settings**, p. 20.

Direct Voice Mail allows an inside caller to call directly or transfer a call directly to another user's voice mail. You can also use the feature *after* you have dialed the extension; just do Step 1 below.

To call directly to another user's voice mail or transfer a call directly to another user's voice mail:

1. Press the programmed **Direct Voice Mail** button,
OR
Press the **Feature** button and select *Direct VM [DrcVM]* or dial **56**.
2. Dial the extension whose voice mail you want to call or transfer a call to; you can use a programmed **Auto Dial** button (p. 11) or a Directory listing (p. 14).

Note: If you are transferring a call to an extension that does not have voice mail, you hear an error tone and the call returns to you after a time interval.

* Release 3.0 and later systems only.

Often-Used Features: Directories

Extension & System Directory

Check with your system manager to find out whether these directories have been programmed. The System Directory dials numbers that people in your company call often. The Extension Directory dials inside numbers.

1. Press the **Menu** button.
2. Select *Directory [Dir]*.
3. For the Extension Directory, select *Ext Dir [ExtDir]*,
OR
For the System Directory, select *System Dir [SysDir]*.
4. Select the entry.

- On *MLX-20L* telephones:
 - a) Select the range of letters that includes the first letter of the listing you want. If there are no listings available for the range, you hear a beep.
 - b) View other listings by selecting either *Prev Page* or *Next Page*.
 - c) If you want to check the number, select *Show Number* and press the button next to the listing. Select *Show Number* again to stop viewing numbers.
 - d) To dial a number, press the button next to the listing.
- On *MLX-10D, MLX-10DP, MLX-16DP, and MLX-28D* telephones:
 - a) Use the dialpad to spell the name and then select *Enter*.
 - b) View other entries that match what you entered by selecting either *Prev* or *Next*.
 - c) To call the number, select *Dial*.
 - d) Select *New* to find another entry. Use the dialpad to spell the name and then select *Enter*.

5. Press the **Home** button to exit.

Personal Directory

On *MLX-20L* telephones only, this feature stores up to 50 phone numbers (as well as account codes, area codes, and access codes), then dials those numbers when you wish. You can enter, change, select, dial, and delete listings from the display. You can place often-used listings on the Home screen.

When entering or changing names, use the screen to select letters A–F; use the line buttons, as labeled on the faceplate, to enter G–Z. Select *Punctuation* to use the displayed punctuation marks. You may need to use special characters (p. 18) when entering dialing sequences. Include dial-out codes if needed.

The screen guides you through Personal Directory activities, so the steps are summarized here. Press **Home** to stop the activity. **Bold** type shows the button you press; *italics* indicate a screen selection.

To enter a listing:

Menu → *Directory* → *Personal Dir* → *Enter New* → Type name → *Enter* → Type number → *Enter* → *Yes* or *No* → *Enter* → **Home**

To assign a listing to the Home screen:

Menu → *Directory* → *Personal Dir* → *Put on Home* → Select letter range → Select listing → Select location on the Home screen → **Home**

To dial a listing on the Home screen:

Home → Press an **ICOM**, line, or **SA** button → Select listing

To dial a listing not on the Home screen:

Home → *Next Page* → *Next Page* → Select letter range → Press a line or **SA** button → Select listing

To verify a stored phone number, use the steps above to display the letter range, and:

Show Number → Select listing → *Show Number*

To delete a listing:

Menu → *Directory* → *Personal Dir* → *Delete Entry* → Select letter range → Select listing → *Delete* → **Home**

To change a listing:

Menu → *Directory* → *Personal Dir* → *Edit Entry* → Select letter range → Select listing → Select part of listing to change → Enter new information → *Enter* → *Exit* → **Home**

Often-Used Features

Do Not Disturb

To program:
See **Programming Buttons & Settings**, p. 20.

This feature prevents calls from ringing at your extension, although outside calls cause the green lights at line buttons to flash. If you have coverage, your calls are covered. If you have a programmed **Posted Messages** button, inside callers with display phones see *Do Not Disturb* when they attempt to call you. A system operator or the person providing individual coverage for you can still call you. Callback calls and returning transfers ring at your phone.

To use:

Press the programmed button to turn on or off. When the feature is on, the green light is on.

Last Number Dial

To program:

See **Programming Buttons & Settings**, p. 20.

This feature automatically redials the last number you called. You should program **Last Number Dial** on a button.

To use:

1. Press the same type of line button used to place the first call (for example, **ICOM** or **SA**).
2. Press the programmed **Last Number Dial** button,
OR
Press the **Feature** button and dial **84**.

Forward & Follow Me

To program:

See **Programming Buttons & Settings**, p. 20.

Forward and Follow Me both send your calls to another phone when you are busy and need your calls covered or when you are not working at your own desk. Turn either off from your extension or the one you are visiting.

- If you want your calls handled at another extension or at an outside number, turn on Forward from your extension.
- If you are working away from your phone, turn on Follow Me at the phone where you are.

If Delayed Call Forwarding is turned on through centralized telephone programming, calls ring at the forwarding extension for the programmed number of rings (0–9) before being forwarded. To change the Delayed Call Forwarding setting, contact your system manager.

To forward calls to another extension:

1. Press the button you have programmed, **OR** Press the **Feature** button and dial **33**.
2. Dial the extension.

To forward calls to an outside number (if enabled):

1. Press the button you have programmed, **OR** Press the **Feature** button and dial **33**.
2. Dial the dial-out code, outside number, and **#**.

To set up Follow Me and receive calls at another extension:

1. Press the **Feature** button and dial **34**.
2. Dial your extension.

To cancel Forward and Follow Me:

- To cancel forwarding or following of your own calls: at your extension, press the **Feature** button, dial **33** and your extension.
- To cancel all extensions forwarded or followed to yours: at your extension, press the **Feature** button, dial ***34***.
- To cancel one extension forwarded or followed to yours: at your extension, press the **Feature** button, dial ***34** and that extension.

Often-Used Features

Night Service

Your company may use Night Service to treat calls differently after hours. If Night Service is on, you may not be able to make outside calls, or you may need a password to do so. See your system manager for a password and/or emergency numbers you can dial without a password.

To make an outside call and override Night Service, press the **Hold** button and dial the password. Then lift the handset or press the **Speaker** button and dial the call.

Paging

To program:

See **Programming Buttons & Settings**, p. 20.

You can page an individual at his or her phone by using an **ICOM Voice** or **SA Voice** button (see **Line Buttons**, p. 2). Or you may be able to page all speakerphones or groups of speakerphones, depending upon how your system is set up. If your company has a loudspeaker paging system, use it to page the whole company or just people in a certain paging zone.

To program or use Speakerphone Paging, check with your system manager for Group Paging or Page All numbers, then:

1. Press any **ICOM** or **SA** button and lift the handset.
2. Dial a Group Paging or Page All number, **OR** Press the button you programmed for Group Paging or Page All.
3. After the beep, make the announcement and hang up.

Ask your system manager whether Loudspeaker Paging is available and if there is a list of paging zones. To use:

1. Press any **ICOM** or **SA** button and lift the handset.
2. Press the **Feature** button.
3. Select **Loudsprkr Pg [LdsPg]** and dial the zone, if necessary.
4. Make the announcement and hang up.

To use when a button is programmed:

1. Lift the handset, press the programmed button and dial the zone, if necessary.
2. Make the announcement and hang up.

Park & Pickup

To program:

See **Programming Buttons & Settings**, p. 20.

Park puts a call on a special kind of hold so that it can be answered from any phone in the system. While a call is parked, use Paging to summon the co-worker who should answer. The person picks up the call using Pickup (p. 17) and dialing your extension.

To use Park and Paging:

1. Park the call.
 - Press the **Park** button you programmed, **OR**
 - Press the **Transfer** button, dial your extension, and press **Transfer** again, **OR**
 - Press the **Feature** button and select **Park**.
2. Set up the page:
 - *For Speakerphone Paging:*
 - a) Press the appropriate **Group Page** or **Page All** button, **OR** Press any **ICOM** or **SA** button and dial the Group Page or Page All extension.
 - b) Announce the call and give your extension.
 - *For Loudspeaker Paging:*
 - a) Press the programmed **Loudspeaker Paging** button, **OR** Press the **Feature** button and select **LoudsprkrPg [LdsPg]**. If necessary, dial the zone.
 - b) Announce the call and give your extension.
3. Hang up.

To pick up a parked call:

1. Lift the handset.
2. Press the programmed **Pickup** button, **OR** Press the **Feature** button and dial **9**.
3. Dial the extension where the call is parked.

Often-Used Features

Personal Speed Dial

Use on MLX-10D, MLX-10DP, and MLX-16DP telephones only. For MLX-20L telephones, use Personal Directory (p. 14). For MLX-28D telephones, use programmed **Auto Dial** buttons (p. 11).

Use this feature to program 2-digit codes that you can dial in place of frequently used numbers. Include the complete dialing sequence and press and release the **Hold** button to enter a dialing pause. Using the 2-digit codes ◆, you can program up to 24 numbers on the MLX-10D or MLX-10DP, and up to 18 numbers on the MLX-16DP.

You cannot program an account code together with a phone number in a Personal Speed Dial code.

To program a Personal Speed Dial code:

1. Press the **Menu** button.
2. Select *Ext Program [Prog]*.
3. Dial # (ignore instructions on the display to select a button), a 2-digit code ◆, and then *21.
4. Dial the phone number, including dial-out code. See **Special Characters** table, p. 18.
5. Select *Enter*.
6. Repeat Steps 3–5 for additional codes.
7. Press **Home**.

To use:

1. Select a line button.
2. Press the **Feature** button.
3. Dial the 2-digit code ◆.

- ◆ Two-Digit Personal Speed Dial Codes:
01–24 for MLX-10D and MLX-10DP telephones
01–18 for MLX-16DP telephone

Pickup

Pickup lets you pick up calls that are not ringing at your phone. Using Pickup, you can answer a parked call (see **Park & Pickup**, p. 16), a call ringing at a specific extension, or a call ringing on a specific line. If you are part of a Pickup group, you can pick up a call ringing anywhere in the group. Program a general **Pickup** button that activates the feature or a specific **Pickup** button to take a call for a group (example: **Pickup Sales**) or at a specific line or extension (example: **Pickup Maria**).

Ask your system manager if you are a member of a Pickup group and get the Pickup group number.

To program:

1. Label a button.
2. Press the **Menu** button.
3. Select *Ext Program [Prog]*.
4. Select *Start*.
5. Press the button to be programmed.
6. Select *ListFeature [List]*.
7. Select *Pickup [Pkup]*.
8. Select *General [Genr]* for any line or extension; select *Extension [Ext]* or *Line* for a specific extension or line; select *Group* for a group of extensions.
9. Select *Enter* and follow the prompts on screen; select *Enter* again when you're done.
10. Press the **Home** button.

To use:

- Press the programmed button. For a line or an extension that is not programmed, also dial the extension or line number.
- You can also use Group Pickup by pressing the **Feature** button and selecting *PickupGrp [PkupG]* from the display or dialing **88**.

Privacy

To program:

See **Programming Buttons & Settings**, p. 20.

Privacy prevents co-workers who share a line with you from joining your calls. Turn the feature on before or during a call; it remains on until you turn it off. A call on hold is not protected by Privacy. You should program Privacy on a button so that you will have a green light to remind you when the feature is on.

Often-Used Features

Saved Number Dial

Must be programmed on a button. To program:
See **Programming Buttons & Settings**, p. 20.
Use this feature to redial a busy or unavailable number that you want to try later.

To use:

1. Before hanging up, press the programmed **Saved Number Dial** button.
2. Press the same type of button used to place the call (for example, **ICOM**, **Pool**, or **SA**).
3. To redial, press the programmed **Saved Number Dial** button.

System Speed Dial

To program:

See **Programming Buttons & Settings**, p. 20.

You can program 3-digit System Speed Dial codes on a button. These are the same numbers that are available from the System Directory (p. 14). Dial these directly by pressing the **Feature** button and dialing the code (600–729).

Special Characters

Features that dial numbers automatically may need special characters to allow for correct dialing or system response.

Press...	See...	Means...
Drop	s	Stop. Halts dialing sequence to allow for system response.
Hold	p	Pause. Inserts 1.5-sec pause in dial sequence. Multiple consecutive pauses allowed.
Conf	f	Flash. Sends switchhook flash. Must be first entry in sequence.
##	#	For Extension Programming only (<i>Ext Program [Prog]</i>): End of Dialing. Use to signal end of dialing sequence or to separate grouped digits.
#	#	For dialing and Directory listings: End of Dialing. Use to signal end of dialing sequence or to separate grouped digits.

Voice Announce

To program:

See **Programming Buttons & Settings**, p. 20.

Make voice-announced calls from **ICOM Voice** or **SA Voice** buttons on your phone (see **Line Buttons**, p. 2) or use Paging (p. 16). The Voice Announce feature allows you to prevent voice announcements and paging calls from interrupting you. Instead, the calls ring. Voice Announce is a setting that you can turn on or off without programming a button for it. If you have a data station at your extension and Voice Announce on, you should turn Voice Announce off.

Display Reference

MLX-28D, MLX-10DP, MLX-16DP, and MLX-10D telephones have a 2-line screen, 24 characters wide. MLX-20L telephones have a 7-line screen, 24 characters wide. Your phone has 4 basic displays, described below.

The display is controlled by the **Home**, **Menu**, **Feature**, and **Inspct** buttons, which bring up the 4 basic screens. (See p. 1 for a picture of the **Feature** and **Inspct** buttons.) The **Home**, **Menu**, and **Inspct** buttons are located either below or next to your screen, as is the **More** button. The **More** button is available when a > appears next to or above it on the screen; the > means that you can press the **More** button to see additional choices or information. Unlabeled display buttons are positioned next to or below your choices. Press one to select an item from the screen.

Note:* If your company has Caller ID services and Caller ID is supported in a caller's area, an outside caller's phone number may appear on your display when an outside call comes in or is transferred to you. When caller information is not available because of the caller's local phone company or because the caller has blocked the service, you may see *Out of Area*, *No Caller ID*, or *Private*.

Home Screen

The Home screen is displayed when you have not chosen another screen or by pressing the **Home** button. The screen contains different information, depending upon your activity. In general, during a calling activity Lines 1 and 2 of the Home screen show prompts and feedback to guide you.

When phone is idle, shows posted message, if any. When a call comes in or is made, shows number called, name or number of caller, or other call-handling information.

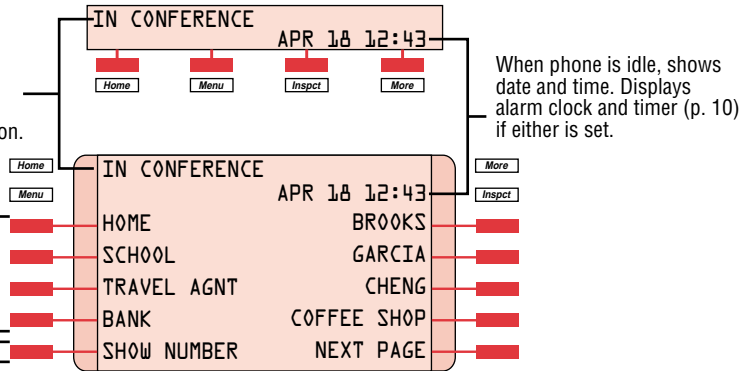

MLX-20L telephone users can assign up to 16 Personal Directory (p. 14) listings to this screen.

This line shows Directory and navigational options.

Menu Screen

Press the **Menu** button to list features available only from the display and program your phone or line buttons. MLX-28D, MLX-10DP, MLX-16DP and MLX-10D telephone users can display additional choices by pressing the **More** button.

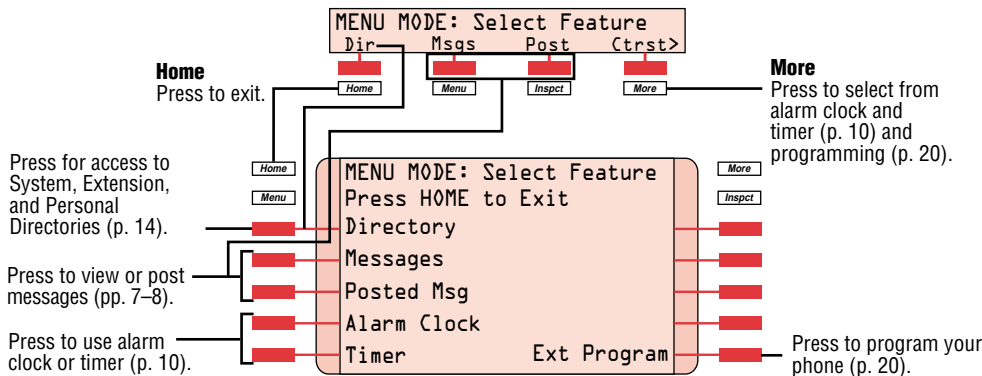

Feature Screen

This screen provides rapid access to often-used features; press the **Feature** button to display it. Available features vary according to your calling activity and how your phone is programmed. The picture below shows the Feature screen when you have just selected an **ICOM** or **SA** button or when you are not on a call. The table below shows the sets of features available on each of the other 3 Feature screens. (If you have an MLX-28D, MLX-16DP, MLX-10DP, or MLX-10D telephone, you may need to press the **More** button to see all of the features in a set.) The MLX-28D, MLX-16DP, MLX-10DP, and MLX-10D telephones display abbreviations are shown in [].

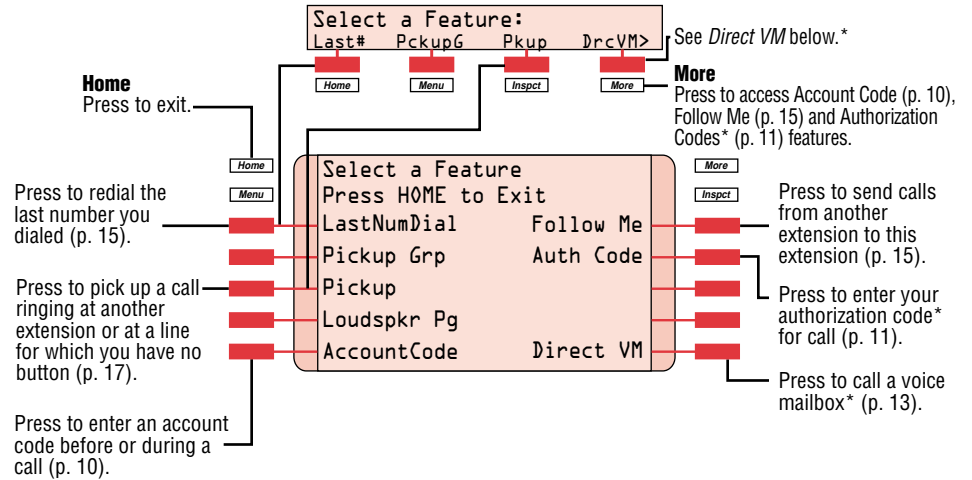

Feature Screen Options		
When you:	These options are available:	
Have reached a busy extension	<i>Cback Sel</i> [CbckS] <i>Leave Msg</i> [LvMsg]	<i>Camp On</i> [Camp] [†]
Have made a call to an extension and it is ringing or you are on an inside call	<i>Leave Msg</i> [LvMsg] <i>Park</i> [Park]	<i>Camp On</i> [Camp] [†] <i>Direct VM</i> [DrcVM]
Are connected to an outside line	<i>LastNumDial</i> [Last#] <i>Park</i> [Park] <i>Camp On</i> [Camp] [†]	<i>AccountCode</i> [Acct] <i>Follow Me</i> [FlwMe] <i>Direct VM</i> [DrcVM]

[†] Do not use if your company has a voice mail system.

Inspct Screens

An Inspct Screen appears when you press the **Inspct** button and then press a line button.

- If you are on a call, calling information is displayed. If you are on a call and another call comes in, press the **Inspct** button and then the line button for the ringing call to display information about the new call without interrupting your current activity.
- If you are not on a call, the line or feature programmed on the button is displayed. If the button is programmed with Last Number Dial or Saved Number Dial, the last or saved number is shown on the screen.

To exit from the Inspct screen, press the **Home** button.

Display Reference

Feature Name	2-Line Display Abbreviation	Feature Name	2-Line Display Abbreviation
Account Code Entry	<i>Acct</i>	Notify	<i>Ntfy</i>
Alarm Clock	<i>AlClk</i>	notify receive	<i>Recv</i>
Authorization Code Entry	<i>Auth</i>	notify send	<i>Send</i>
Auto Dial	<i>AutoD</i>	Paging	
inside (extension)	<i>In</i>	group paging	<i>GrpPg</i>
outside	<i>Out</i>	loudspeaker paging	<i>LdsPg</i>
Callback	<i>CbckS</i>	Park	<i>Park</i>
Call Waiting	<i>CWait</i>	Personalized Ring	<i>PRing</i>
Camp-On	<i>Camp</i>	Pickup	<i>Pkup</i>
Conference	<i>Conf</i>	general	<i>GenI</i>
Contrast	<i>Crst</i>	group pickup	<i>PkupG</i>
Coverage	<i>Cover</i>	inside (extension)	<i>Ext</i>
Coverage VMS	<i>CvVMS</i>	outside (line)	<i>Line</i>
group	<i>Group</i>	Privacy	<i>Prvcy</i>
primary individual	<i>Prmry</i>	Recall	<i>Recll</i>
secondary individual	<i>Secnd</i>	Reminder	<i>Rmind</i>
inside only	<i>CvIns</i>	cancel	<i>Cancl</i>
off	<i>CvOff</i>	set	<i>Set</i>
Directory	<i>Dir</i>	Ring Options	
extension	<i>ExtDir</i>	all lines	<i>AllLn</i>
personal	–	one line	<i>1Line</i>
system	<i>SysDir</i>	delayed ring	<i>Delay</i>
Direct Voice Mail	<i>DrcVM</i>	immediate ring	<i>Immed</i>
Do Not Disturb	<i>DND</i>	no ring	<i>No</i>
Drop	<i>Drop</i>	abbreviated ring	<i>Abbrv</i>
Extension Programming	<i>Prog</i>	Send Ring	<i>SnRg</i>
Follow Me	<i>FlwMe</i>	Saved Number Dial	<i>Save#</i>
Forward	<i>Forwd</i>	Signaling	<i>Signl</i>
Group Calling	<i>GrpCl</i>	System Speed Dial	<i>SpdDI</i>
Headset/Handset	<i>Hdset</i>	Timer	<i>Timer</i>
Headset Auto Answer	<i>Auto</i>	Transfer	<i>Trans</i>
Headset/Handset Mute	<i>Mute</i>	Voice Announce	<i>Voice</i>
Headset Status	<i>Stat</i>	place calls	<i>Place</i>
Last Number Dial	<i>Last#</i>	receive calls	<i>Recv</i>
Messaging	<i>Msgs</i>	ringing calls	<i>Ring</i>
delete message	<i>Delete</i>	voice-announced calls	<i>Voice</i>
leave message	<i>LvMsg</i>		
return call	<i>Call</i>		
next message	<i>Next</i>		
posted message	<i>Post</i>		

Programming Buttons & Settings

If you use a feature often, you can program it onto an unused line button for easy access. If you use a feature occasionally, see **Using Features**, p. 9. Keep these facts in mind when setting up your telephone:

- Some features *must* be programmed on a button or they can't be used. (These features are marked with a ♦ on the **Programming Codes** list.)
- Other features (marked with • on the **Programming Codes** list) are settings that affect the way your phone works. Some settings, such as Personalized Ring, affect all the lines on your phone. During programming, you still have to select a line button, but it can be *any* line button the feature affects. Others, such as Delay Ring for a single line, are settings that affect a specific line and require you to press it during programming (these features are noted on the **Programming Codes** list). Settings remain active until you program them again.

To see whether a feature is programmed on a line button, press the **Inspct** button and then the line button. Read the display and press the **Home** button to exit.

While programming, either make a selection from the display (press the button next to or below the item) or use codes. Using codes takes fewer steps, but requires the **Programming Codes** list. As you program, your phone beeps.

Display Programming

To program using the display:

1. If programming a feature on a button, label the button.
2. Press the **Menu** button and select *Ext Program [Prog]*.
3. Select *Start*.
4. Press the line button you are programming. If a feature is already programmed, its name appears on the display. If you are programming a setting, either press the line button affected or press any line button.

5. Select *ListFeature [List]* and search for the feature name. If you see > on the screen, press the **More** button to see more feature names. (Consult the **Display Reference** if you need help with abbreviations.)
6. Select the feature. If additional numbers (such as an extension number) are needed, dial them.
7. Press *Enter* to finish programming. If you wish to program another button, begin again with Step 4. (Label the buttons first.)
8. Press the **Home** button to exit at any time.

Code Programming

To program using programming codes:

1. If programming a feature on a button, label the button.
2. Press the **Feature** button and dial **00**.
3. Press the line button you are programming. If a feature is already programmed, its name appears on the display. If you are programming a setting, either press the line button affected or press any line button.

4. Select the code from **Programming Codes** list and dial it. If additional numbers (such as an extension number) are needed, dial them, too.
5. Press *Enter* to finish programming. If you wish to program another button, begin again with Step 3. (Label the buttons first.)
6. To exit, press the **Feature** button and dial ***00**.

Programming Buttons & Settings

Programming Codes

Account Code Entry	* 82	Park	* 86
Authorization Code Entry ■	* 80	Personal Speed Dial	# + (2-digit code†) + * 21 + phone number + #
Auto Dial♦			# + (2-digit code†) + * 21 + dial-out code + phone number + ##
inside	* 22 + extension		
outside	* 21 + number		
Callback			
automatic callback off ●▲	** 12		
automatic callback on ●▲	* 12		
selective callback	* 55		
Call Waiting ●		Pickup	
off	** 11	general	* 9
on	* 11	group	* 88
Camp-On▲	* 57	inside	* 9 + extension
Coverage		outside	* 9 + line number
Coverage inside on ●	* 48	Privacy	* 31
Coverage inside off ●	** 48	Recall	* 775
Buttons for covering calls♦		Reminders▲	
Primary Cover	* 40 + sender's extension number	set reminder	* 81
Secondary Cover	* 41 + sender's extension number	cancel reminder	** 81
Group Cover	* 42 + sender's group number	Ringing Options ●	
Buttons for sending calls♦		abbreviated on	* 341
Coverage Off	* 49	abbreviated off	* 342
Coverage VMS Off	* 46	delayed all lines	* 346
(outside calls only)		delayed one line	* 36
Direct Voice Mail ■	* 56	immediate all lines	* 347
Do Not Disturb♦	* 47	immediate one line	* 37
Forward	* 33	no ring all lines	* 345
Headset Auto Answer♦	* 780	no ring one line	* 35
Headset Hang Up	* 781	personalized ring	* 32 + ring (1–8)
Headset/Handset Mute♦	* 783	send ring on	* 15
Headset Status♦	* 782	send ring off	* * 15
Last Number Dial	* 84	Saved Number Dial♦	* 85
Messaging		Signaling and Notify♦	
leave message	* 25	signaling	* 23 + extension
Paging group or all	* 22 + group extension	notify receive	* 758 + extension
Paging loudspeaker	9 + line number	notify send	* 757 + extension
		System Speed Dial	* 24 + code (600–729)
		Voice Announce ●	
		on	* 10
		off	* * 10

- ♦ Must be programmed onto a line button.
- Sets up how your phone works. Use a line button to program (turn on or off). The setting is not programmed onto a line button.
- ▲ See your system manager for details.
- Release 3.x systems only.
- † The MLX-16DP telephone has 18 Personal Speed Dial codes (01–18). The MLX-10D and MLX-10DP telephones have 24 Personal Speed Dial codes (01–24).

Feature Codes

Account Code Entry	82 + code + #	Messaging	
Authorization Code Entry ●	80 + code + #	cancel message ■	* 53 + extension
Callback	55	leave message	25
Call Waiting		leave message without calling ■	53 + extension
pick up call waiting call ■	87	Paging loudspeaker	9 + line number + zone
Camp-On	57	Personal Speed Dial ■	2-digit code [†]
Direct Voice Mail ●	56	Pickup	
Follow Me	34 + extension	group	88
Forward		inside	9 + extension
inside	33 + extension	outside	9 + line number
outside	33 + dial-out code + number + #	Privacy	
Forward and Follow Me		off	* 31
cancel from all extensions ■	* 34 *	on	31
cancel from one extension ■	* 34 + extension	Recall	775
cancel from your phone	33 + your extension	Reminders	
Language ▼		set reminder ▼	81 + time + 2 or 7
English	790	cancel reminder	* 81
French	791	System Speed Dial	code (600–729)
Spanish	792		
Last Number Dial	84		

■ Available only by using feature code.

▼ For time functions, English operates on 12-hour clock (2 or 7). French and Spanish operate on 24-hour clock.

● Release 3.0 and later systems only.

† Two-Digit Personal Speed Dial Codes:
01–24 for MLX-10D and MLX-10DP telephones
01–18 for MLX-16DP telephone

Special Characters

Features that dial numbers automatically may need special characters to allow for correct dialing or system response.

Press...	See...	Means...
Drop	s	Stop. Halts dialing sequence to allow for system response.
Hold	p	Pause. Inserts 1.5-sec. pause in dial sequence. Multiple consecutive pauses allowed.
Conf	f	Flash. Sends switchhook flash. Must be first entry in sequence.
##	#	For Extension Programming only (<i>Ext Program [Prog]</i>): End of Dialing. Use to signal end of dialing sequence or to separate grouped digits.
#	#	For dialing and Directory listings: End of Dialing. Use to signal end of dialing sequence or to separate grouped digits.