

## SCHEMATIC SYMBOLS FOR ATTACHED-CONTACT DRAWINGS

CONTENTS	PAGE
1. GENERAL . . . . .	1
2. SYMBOL COMPONENTS . . . . .	2
A. Attached-contact Schematic Symbols .	2
B. Detached-contact Schematic Symbols .	6
3. PRIMARY WIRING SYMBOLS . . . . .	7
4. COMPLETE APPARATUS SYMBOLS . . . . .	9
5. COAXIAL AND WAVEGUIDE SYMBOLS . . . . .	34
REASON FOR REISSUE . . . . .	39
ALPHABETICAL INDEX . . . . .	40

### 1. GENERAL

1.01 This section was previously numbered Section AA612.016, A804.002, and also replaces Section B804.002. It covers schematic symbols specifically used in the preparation of Bell System attached-contact type schematic drawings. When symbols not listed in this section are required, the matter shall be referred, through normal lines of organization, to the Bell Telephone Laboratories, Incorporated, New York, N. Y. (Standards Engineer - Dept 5241) for the establishment of new symbols.

(a) Other symbols not necessarily applicable to Bell System drawings may be found in "Graphical Symbols for Electrical Diagrams Y32.2" prepared by the American Standards Association for use in the electrical industry generally.

(b) Cabling diagrams for schematic drawings shall conform with Section AA610.004.

(c) Detached-contact type schematic drawings shall conform with Section 950.701.01.

(d) Section AA612.001, A804.009 covers wiring symbols, wiring abbreviations, and definitions for wiring and cabling.

1.02 Changes in requirements which have been made with this issue are explained under reason for reissue at the end of the section. Since this reissue covers a general revision, arrows ordinarily used to indicate changes have been omitted.

1.03 The schematic symbols shown herein are designed to indicate the electrical function of the apparatus.

1.04 The standard symbol for a terminal (o) may be added to each point of attachment of conductors to any one of the graphical symbols, but such added terminal symbols should not be considered as part of the individual graphical symbol itself.

1.05 Each symbol shown in this section is the size actually used on the original schematic drawing. The sizes of symbols shown on prints in the field may be shown smaller due to print reduction.

1.06 The orientation of a symbol on a drawing does not alter the meaning of the symbol. In most cases, apparatus symbols may be rotated or reversed in order to simplify the circuit layout. Exceptions to this are made in the case of symbols which require a definite position in order to identify the top, bottom, left, or right side of the apparatus. In such cases, the symbol is considered as looking at the wiring side.

1.07 Functional or reference designations of apparatus are placed at some point near the apparatus. Code designations include the apparatus name only when required to insure complete understanding.

2. SYMBOL COMPONENTS

A. Attached-contact Schematic Symbols

2.01 Symbol components that are used in Bell System applications are found in this section. Symbols used previously, which have been revised to conform with present standards, are indicated as Discontinued and will not be used on new schematic drawings.

2.02 The symbol components listed herein show the general methods of representing particular features of a piece of apparatus.

2.03 Contact

(a) Fixed, adjustable, or sliding contacts

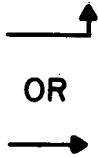

(b) Moving contact or armature for relays, nonlocking keys, etc (circle indicates pivot point and is always shown on moving contacts)

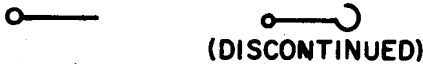

(c) Moving contact for locking keys, jacks, etc



(d) Normally closed and normally open contact

(1) Normally closed (break) contact (NC)



(2) Normally open (make) contact (NO)

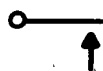

**Note:** Whether a contact is normally open (NO) or normally closed (NC) depends on the position of the contact when the actuating

device is in the de-energized or nonoperated position.

2.04 Core

(a) Core, magnetic (general)



(b) Core for relays, magnets, etc



2.05 Heating Resistor

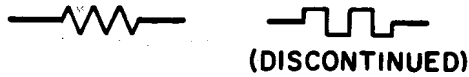

2.06 Inductance — Repeating Coil, Inductor, Transformer, etc (See 4.12)

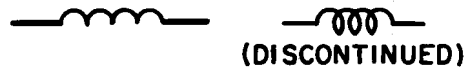

2.07 Thermal Element

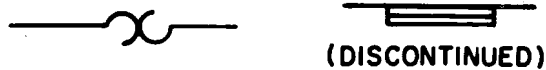

2.08 Transistor (Semiconductor Devices) Components (See 4.17 and 4.65)

(a) Semiconductor region, for example the base region, with one ohmic contact



(b) Semiconductor region with a plurality of ohmic contacts



(c) Transition between P and N regions (either P to N or N to P)

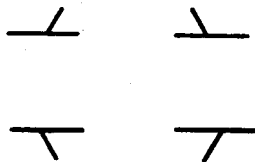

(d) Intrinsic region between regions of similar conductivity type



(e) Intrinsic region between regions of dissimilar conductivity type

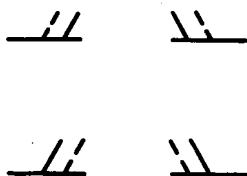

(f) P-emitter on N-region



(g) Plurality of P-emitters on N-region



(h) N-emitter on P-region



(i) Plurality of N-emitters on P-region



(j) Collector on semiconductor region



(k) Plurality of collectors on semiconductor region



(l) P-region rectifying junction

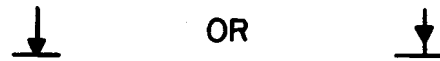

(m) N-region rectifying junction



(n) Notes

(1) Slant lines indicating transitions shall be appreciably shorter than collector and emitter lines. Note that the transition is along the horizontal line and that no ohmic connection is made at the slant line. See 4.65 (i), (k), and (p) as examples.

(2) The circle enclosing the device symbol is for recognition purposes and its use is recommended.

(3) The following more generally used device properties may be indicated with the aid of identifying letters placed adjacent or within the enclosure.

- B — Breakdown device
- $\tau$  — Storage device
- T — Thermally-actuated device
- $\lambda$  — Light-actuated device

It is recognized that all semiconductor devices are light- and temperature-sensitive, and that they exhibit breakdown and storage characteristics. However, these letters are to be used only if these properties are essential to the operation of the circuit.

2.09 Tube, Electron Components (See 4.67)

(a) Collecting electrode

(1) Anode or plate (including collecting electrode and fluorescent target)



- (2) Target or X-ray anode  
 Drawn at about a 45-degree angle.



- (b) Collecting and emitting electrode

- (1) Dynode



- (c) Alternately collecting and emitting

- (1) Composite anode — photocathode



- (2) Composite anode — cold cathode



- (3) Composite anode — ionically heated cathode with provision for supplementary heating



- (d) Controlling electrode

- (1) Grid (including beam-confining or beam-forming electrodes)



- (2) Deflecting electrodes (used in pairs);  
 reflecting or repelling electrode (used in velocity-modulated tube)

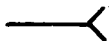

- (3) Ignitor (in pool tubes) (should extend into pool)  
 Starter (in gas tubes)

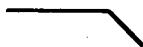

- (4) Excitor (contactor type)



- (e) Coupling (See 5.04)

- (1) Coupling by loop (electromagnetic type)

Coupling loop may be shown inside or outside envelope as desired, but if inside it should be shown grounded.



- (f) Emitting electrode

- (1) Directly heated (filamentary) cathode

Leads may be connected in any convenient manner to ends of the ^ provided the identity of the ^ is retained.



**Note:** A diagram for a tube having more than one heater or filament shall show only one heater or filament symbol ^ unless they have entirely separate connections. If a heater or filament tap is made, either brought out to a terminal or internally connected to another element, it shall be connected at the vertex of the symbol, regardless of the actual division of voltage across the heater or filament.

- (2) Indirectly heated cathode

Lead may be connected to either extreme end of the — or, if required, to both ends, in any convenient manner.



- (3) Cold cathode (including ionically heated cathode)



- (4) Photocathode

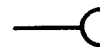

(5) Pool cathode

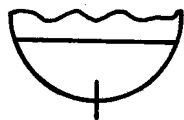

(6) Ionically heated cathode with provision for supplementary heating



(g) Envelope (shell)

The general envelope symbol identifies the envelope or enclosure regardless of evacuation or pressure. When used with electron-tube component symbols, the general envelope symbol indicates a vacuum enclosure unless otherwise specified. A gas-filled electron device may be indicated by a dot within the envelope symbol.

(1) General

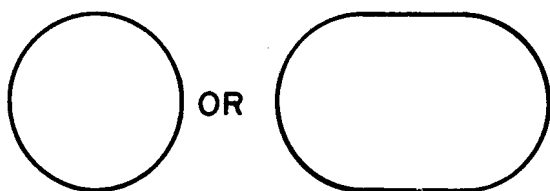

(2) Split envelope

If necessary, envelope may be split.

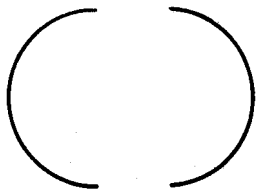

(3) Gas-filled

The dot may be located as convenient

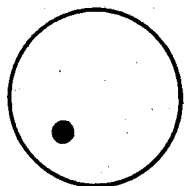

(h) Resonators (cavity type)

(1) Single-cavity envelope and grid-type associated electrodes

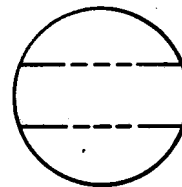

(2) Double-cavity envelope and grid-type associated electrodes

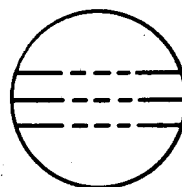

(3) Multicavity magnetron anode and envelope

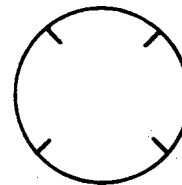

(i) Shield

This is understood to shield against electric fields unless otherwise noted.

(1) Any shield against electric fields that is within the envelope and that is connected to an independent terminal

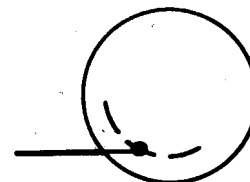

(2) Outside envelope

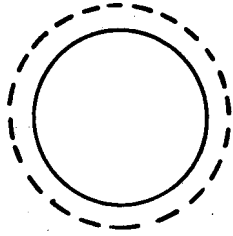

(3) Shield sleeve [Also see 4.67(e)]

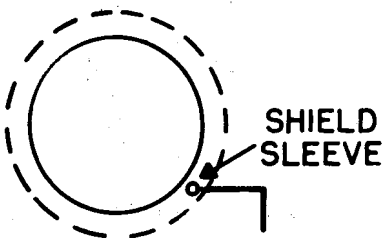

(c) Inner end for windings of relays, electro-magnets, etc



**B. Detached-contact Schematic Symbols**

*Note:* The following are the basic symbols used on detached-contact schematics. For complete information on this type of schematic, see Section 950.701.01.

2.10 *Variable*, when used with normal symbol for capacitor, etc [See 4.08(b) and (c) and 4.12(b) (3), (4), and (5)]



**2.11 Windings**

(a) Inductive winding for relays, electro-magnets, etc

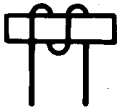

(b) Noninductive winding



**2.12 Make**

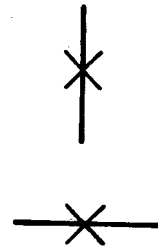

**2.13 Break**

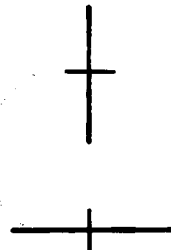



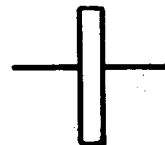









**2.14 Core and Winding**



3. PRIMARY WIRING SYMBOLS

3.01 Line Symbols

TRANSMISSION PATHS (TALKING & TELEGRAPH)	
BUS BAR CHARGE & DISCHARGE LEADS	
FUNDAMENTAL CIRCUIT	
OFF-NORMAL GROUND	
OFF-NORMAL BATTERY	
SEQUENCE SWITCH ROTARY MAGNETIC FEED	
DIVISION LINE USED BETWEEN FIGURES	
SIGNALING & POWER CONTROL	
CIRCUIT CONNECTIONS SHOWN ON OTHER DWGS	
CROSS-CONNECTION WIRE	
BOUNDARY OF MECHANICAL GROUPING	
MECHANICAL LINKAGE & SHIELDING	
SYMBOLS	

3.02 Associated Conductors

(a) Paired twisted wires

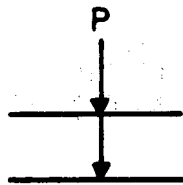

(b) Triple twisted wires

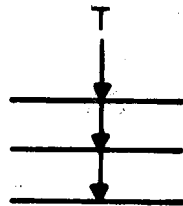

(c) 4-wire twist

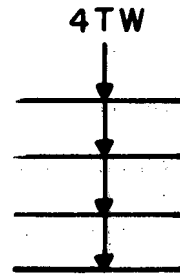

(d) Quad — (two pairs twisted)

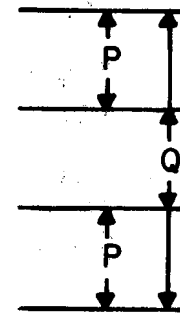

(e) Cross-connection wires

(1) 1-conductor cross-connection wire



(2) 2-conductor cross-connection wire

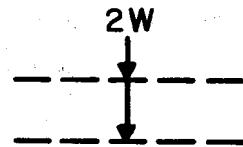

(3) 3-conductor cross-connection wire

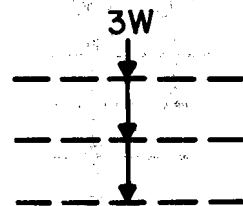

- (4) 4-conductor cross-connection wire (spiral)

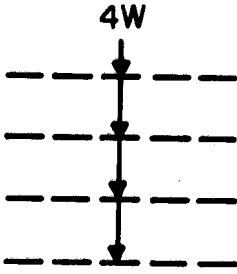

- (5) Multiple twin cross-connection wire

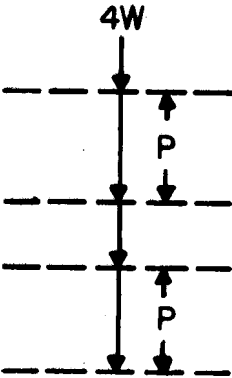

- (f) Cable switchboard

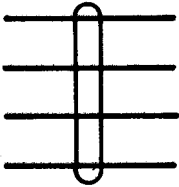

- (g) Cable coaxial (Also see 5)

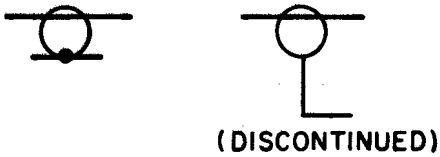

- (h) Local cable or loose wiring

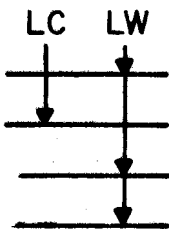

- (i) Leads requiring segregation for crosstalk control, etc



- (j) Leads run from terminal to terminal

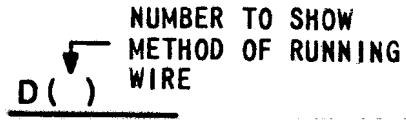

3.03 Methods of Shielding

- (a) Single shielded wire

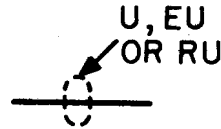

- (b) Individually shielded wires with the shields connected together to ground

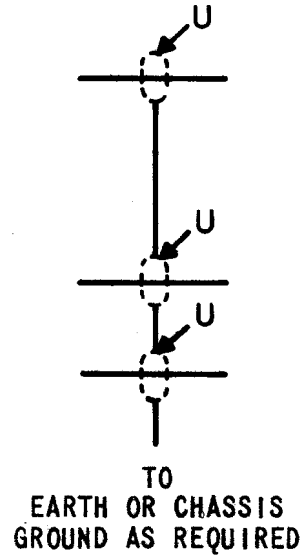

- (c) Wires in same shield

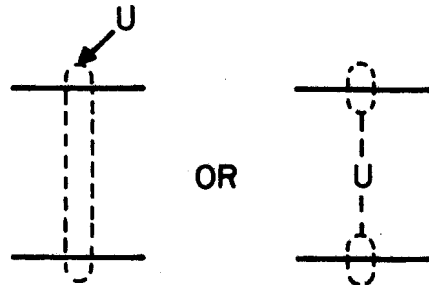



(d) Typical paired and shielded wiring

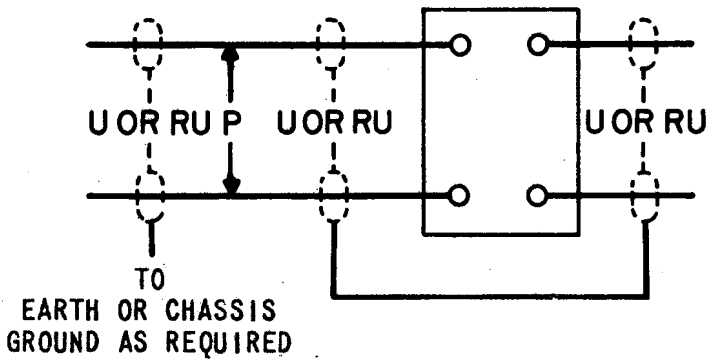

3.04 Paths and Path Junctions

(a) Crossed paths



(b) Joined paths

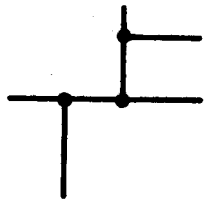

(c) Spliced wires



(d) Multiple connection



(e) Optional or alternate paths

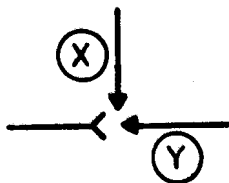

4. COMPLETE APPARATUS SYMBOLS

4.01 Amplifier

(a) Single line

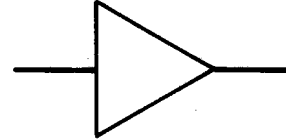

(b) Where more leads are shown

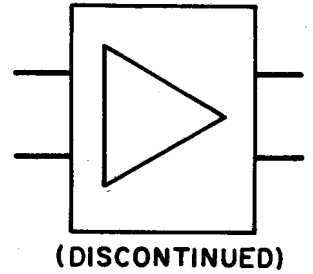
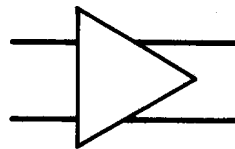

4.02 Antenna

(a) Aerial

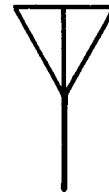

(b) Counterpoise



(c) Loop

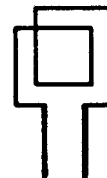

4.03 Autotransformer (See 4.12)

4.04 Batteries and Potential Supply

(a) One cell

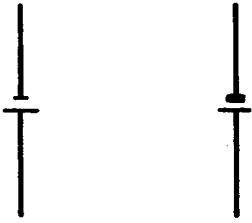

(DISCONTINUED)

(b) Multicell battery  
(showing positive side grounded)

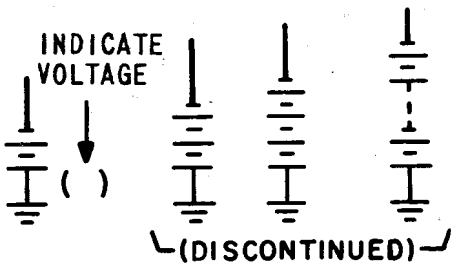

(c) CEMF cells

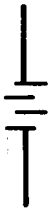

(d) Potential supply



(e) Solar battery



4.05 Bells (Also see 4.50)

(a) AC bell

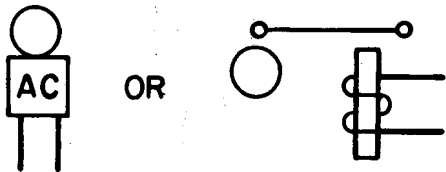

(b) DC bell

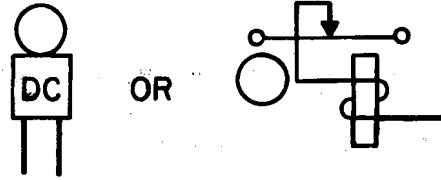

(c) AC-DC bell

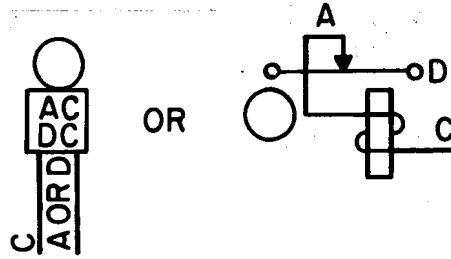

4.06 Binding Post



4.07 Buzzers

(a) AC buzzer

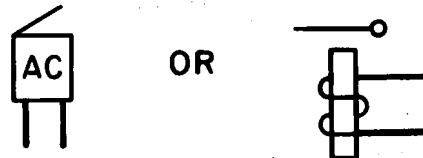

(b) DC buzzer

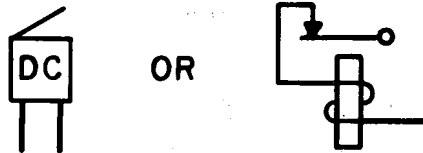

(c) AC-DC buzzer

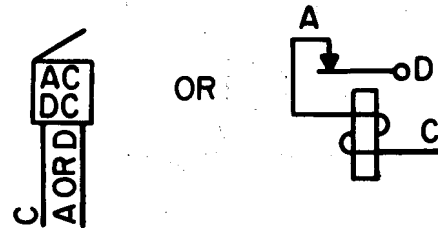

4.08 *Capacitors*

**Note:** When it is required to identify the capacitor electrodes on a circuit drawing, a note shall be placed at the symbol to indicate that the curved element represents the outside electrode in fixed-paper-dielectric and ceramic-dielectric capacitors, the negative electrode in electrolytic capacitors, and the moving element in adjustable and variable capacitors.

(a) Fixed capacitor (See note under 4.08)



(b) Variable or adjustable capacitor

If it is necessary to identify trimmer capacitors, the letter T should appear adjacent to the symbol. (Also see note under 4.08.)

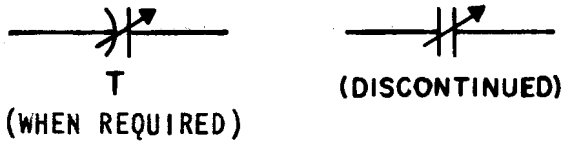

(c) Differential variable capacitor (see note under 4.08)

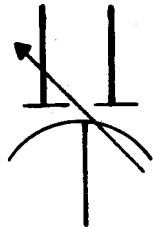

(d) Electrolytic capacitor

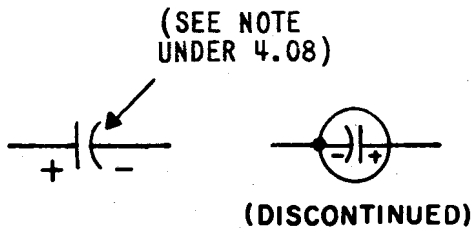

4.09 *Circuit Breaker*



(a) Application

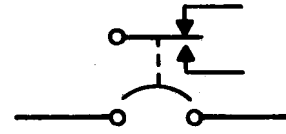

(b) Toggle switch type circuit breaker

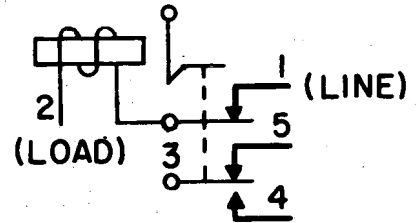

4.10 *Clock, Electric*

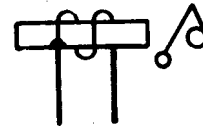

4.11 *Clutch Magnets*

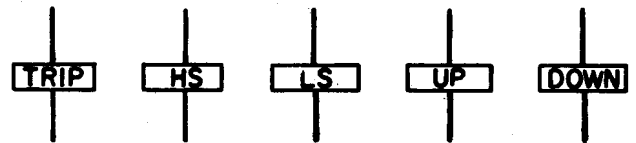

HS - High Speed  
LS - Low Speed

4.12 *Coils* — Autotransformer, Induction Coil, Inductor, Repeating Coil, Transformer  
(Also see 2.06)

(a) Autotransformer

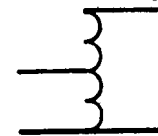

(1) Adjustable

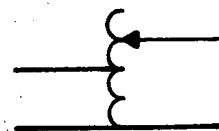

(2) Load-ratio control autotransformer

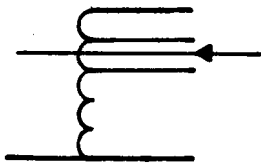

(3) Application  
(Variable tap-type autotransformer)

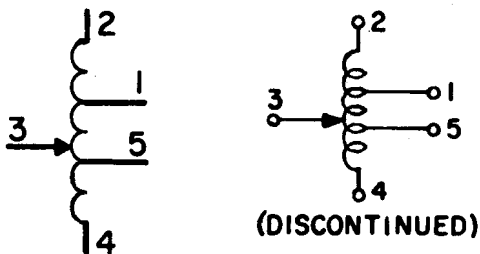

(3) Adjustable inductance winding

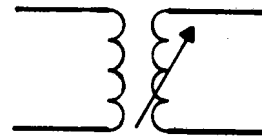

(4) Each winding with separately adjustable inductance

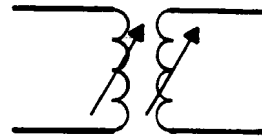

(5) Adjustable mutual inductor, constant-current transformer

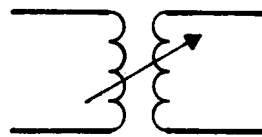

(b) Induction coil, repeating coil, transformer

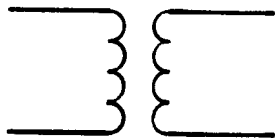

(1) With magnetic core

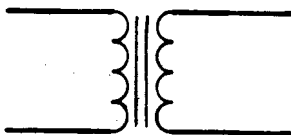

(2) With magnetic core and shield

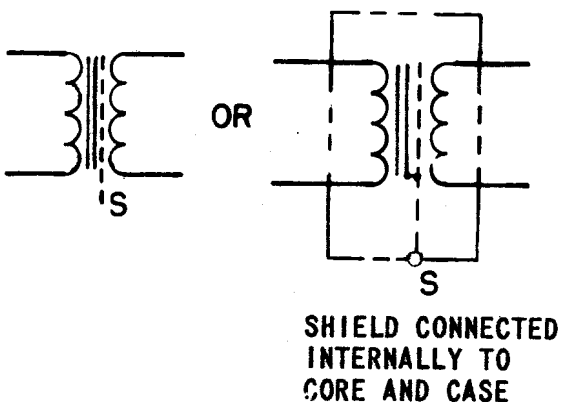

(6) With taps

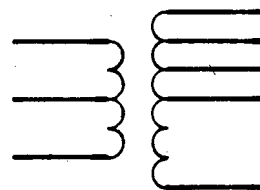

(7) Load-ratio control transformer with taps

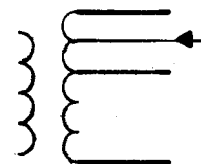

(8) Induction coil

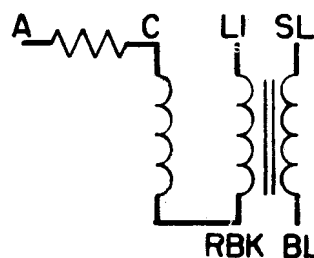

(9) Repeating coil

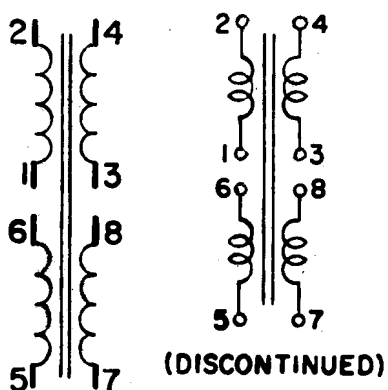

(10) Repeating coil (hybrid-type)

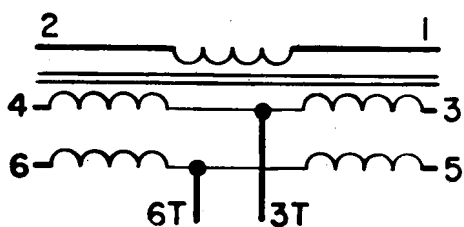

(11) Transformer with electrostatic shield

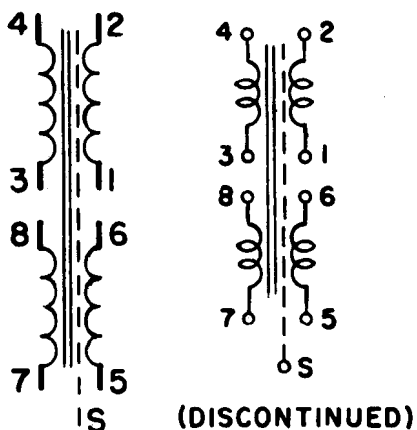

(12) Repeating coil with noninductive winding

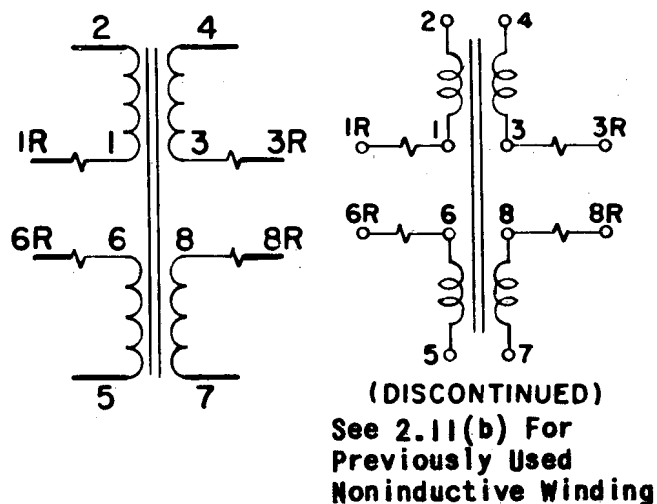

(13) Repeating coil with taps

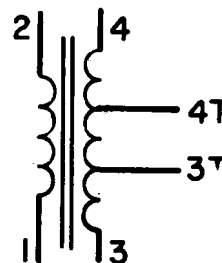

(14) Saturable reactor

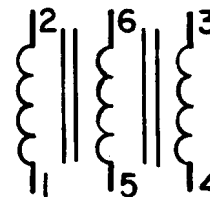

(c) Inductor



(1) With magnetic core



(2) With taps



(3) Adjustable inductor

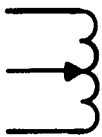

(4) Continuously adjustable inductor



(5) Shunt inductor

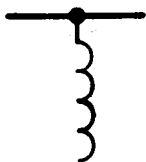

(6) Application

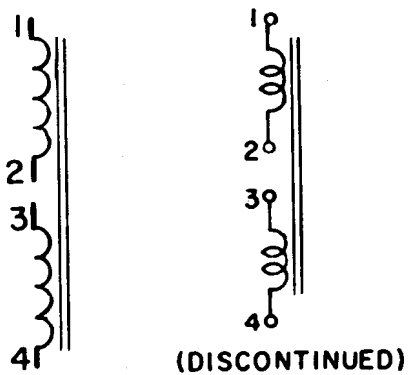

(1) Engaged multiple conductor connector showing individual contact designations when required (See note)

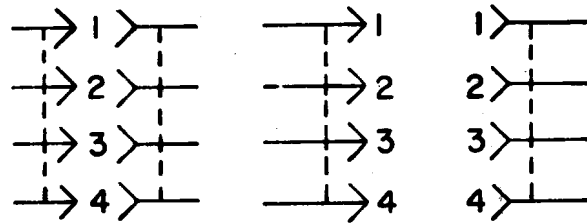

REPEAT NUMBERS WHEN MATES ARE SEPARATED ON THE DRAWING

DISCONTINUED

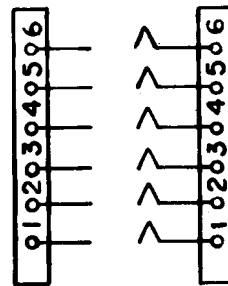

(b) Coaxial connectors

(1) Single line coaxial jack and plug

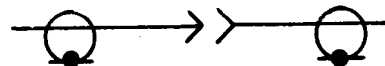

(2) Complete coaxial connectors

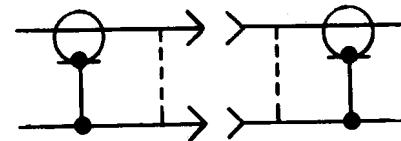

(3) Connector showing discontinuity symbol

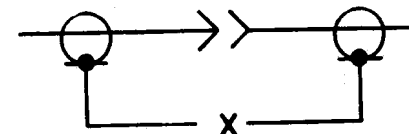

(c) Switchboard-type connectors (jacks and plugs)

(1) 2-conductor jack



4.13 Connectors

Note: Use appropriate number of contact symbols.

(a) Separable connectors showing female and male contacts engaged (See note)



(2) 2-conductor plug



(3) 3-conductor jack

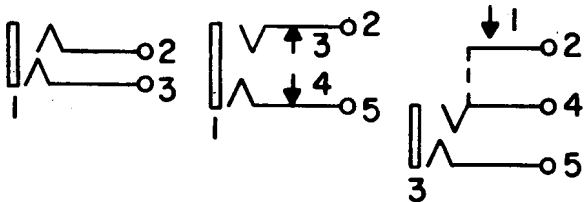

(4) 3-conductor plug

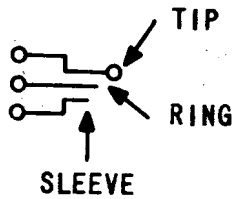

(5) Make-busy or shorting plugs



(6) Dummy plug



(7) Twin-type jacks

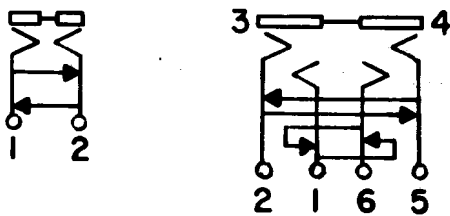

(8) Twin plug

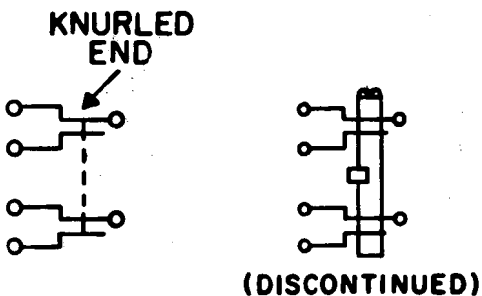

(9) Test-type jack

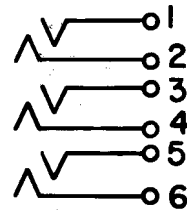

(10) Spring-type jack and plug (engaged)

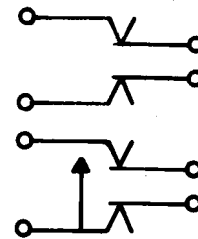

(11) Test plug

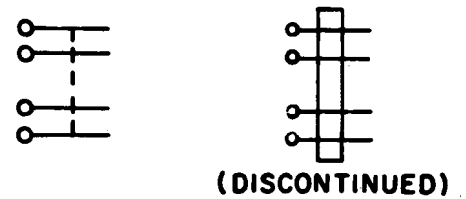

(12) 4-finger plug

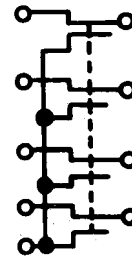

(d) Connectors commonly used for power supply (convenience outlets and mating connectors)

(1) 2-conductor nonpolarized (female contacts)

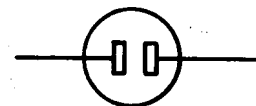

(2) 2-conductor nonpolarized (male contacts)

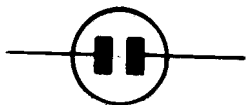

(3) 2-conductor polarized (female contacts)

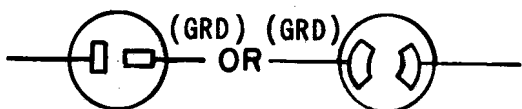

(4) 2-conductor polarized (male contacts)

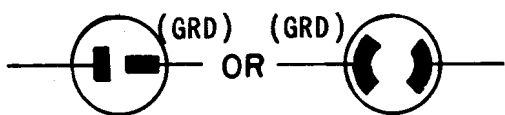

(5) 3-conductor polarized (female contacts)

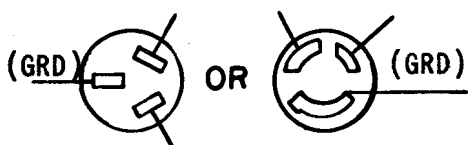

(6) 3-conductor polarized (male contacts)

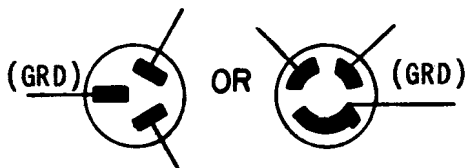

(7) 4-conductor polarized (female contacts)

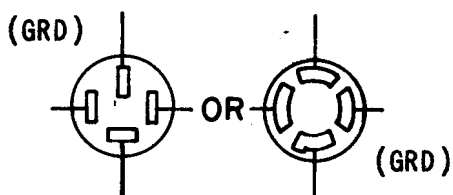

(8) 4-conductor polarized (male contacts)

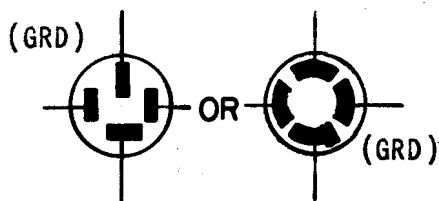

(9) 3-conductor grounding-type polarized (female contacts)

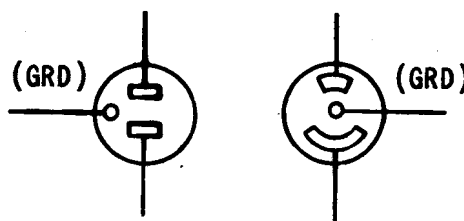

(10) 3-conductor grounding-type polarized (male contacts)

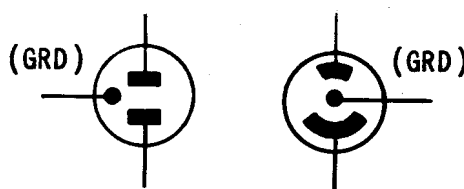

(e) Cord tip-type connector

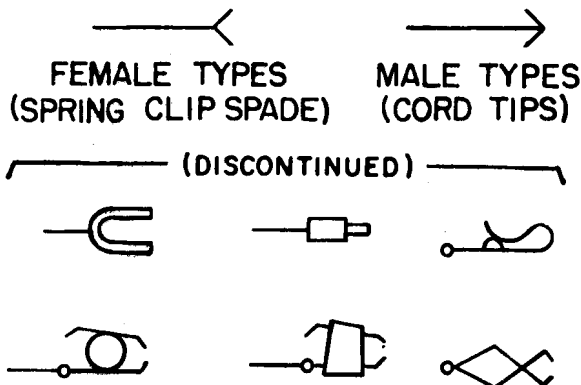

4.14 Contactors

(a) Relay (armature) -type

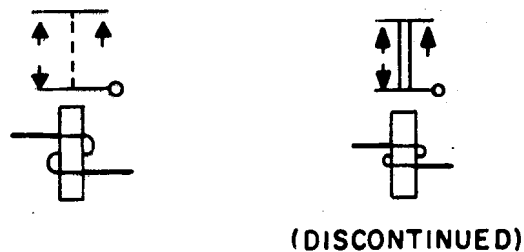



(b) Solenoid-type

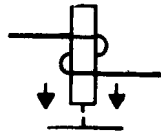

(b) P-N diode, breakdown

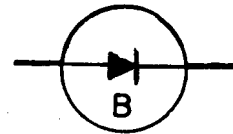

4.15 *Crystal Units*

(a) Piezoelectric

Detector Crystal

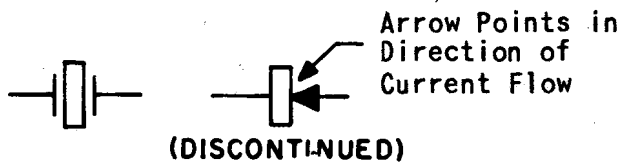

(c) Bi-polar voltage limiter

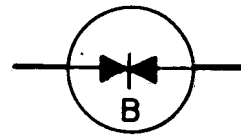

(d) P-I-N triode

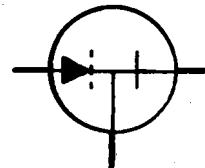

4.16 *Dials*

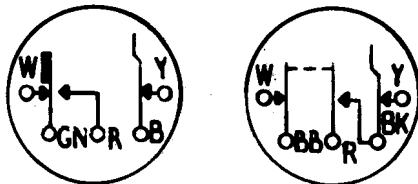

(DISCONTINUED)

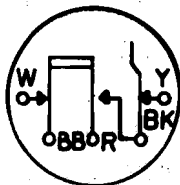

(e) P-I-N diode

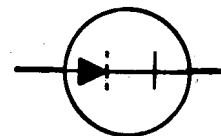

4.18 *Drops*

(a) Manually restored drop

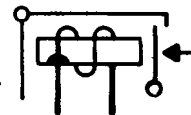

(b) Electrically restored drop

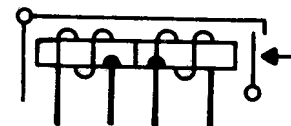

4.17 *Diodes, (Semiconductor Devices)* (Also see 2.08, 4.65, and 4.68)

(a) P-N diode

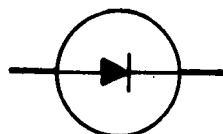

4.19 *Electromagnet*



4.20 Engine-Generator Set

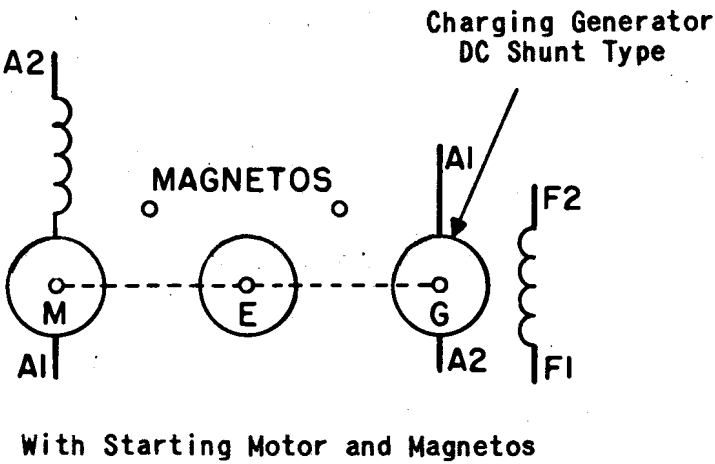

( DISCONTINUED )

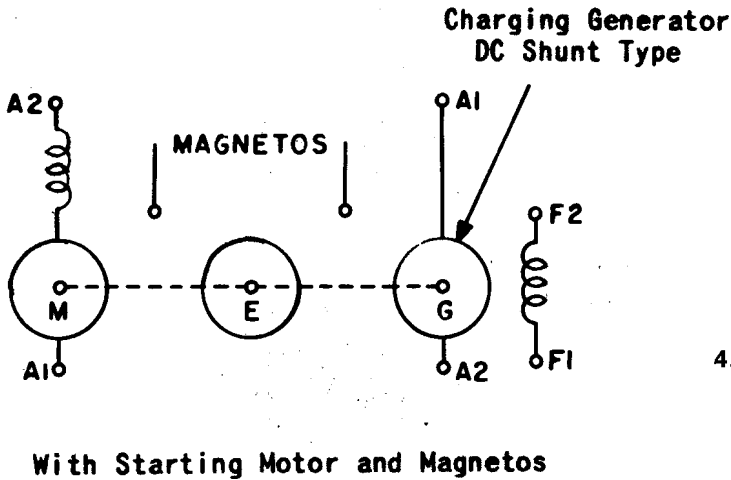

4.21 Fuses

**Note:** When fuse blows, alarm bus A is connected to power bus B. Letters are for explanation and are not part of the symbol.

(a) Fuse (no alarm)



(b) Alarm-type fuse

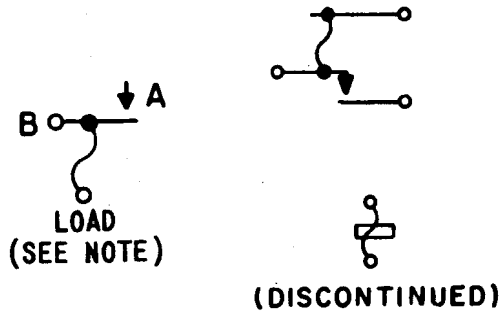

(c) Alarm-type fuse on bus bar

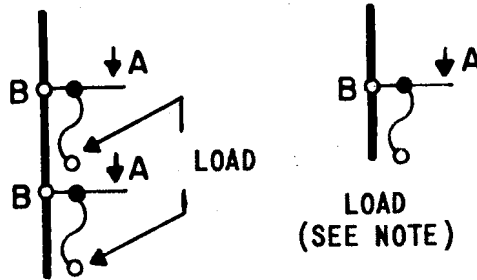

(d) Fuse in safety-type holder



4.22 Generator, Hand-type

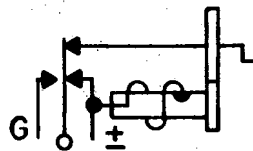

4.23 Ground Symbols

(a) Chassis or frame ground



(b) Earth ground



4.24 Handsets

(a) 3-conductor handset

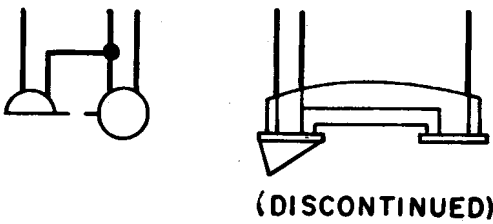

(b) 4-conductor handset

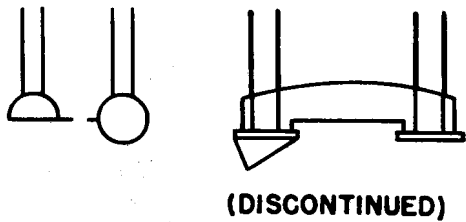

(c) 4-conductor handset with push-to-talk switch

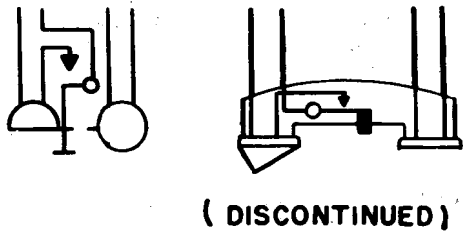

4.25 Headset, Operator (Also see 4.43)



4.26 Heat Coils

(a) Alarm-type heat coil on bus bar

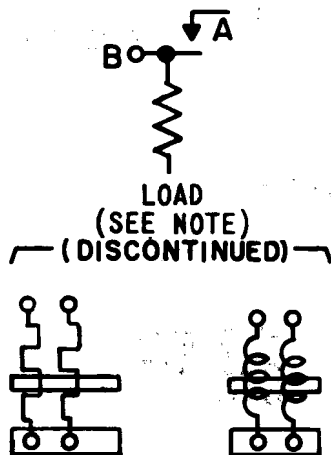

**Note:** When heat coil operates alarm bus A is connected to power bus B. Letters are for explanation and are not part of the symbol.

(b) Protector-type heat coil

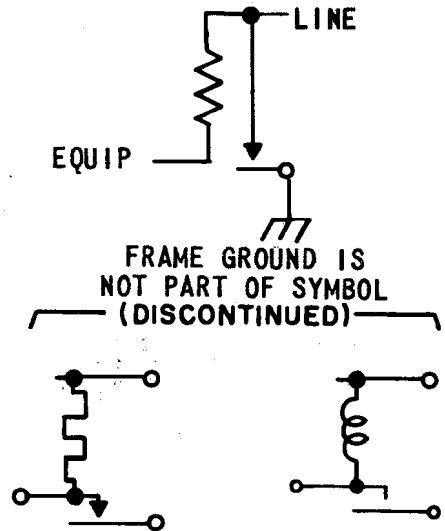

4.27 Horn or Howler (See 4.34)

4.28 Instruments and Meters



\*Show abbreviations to identify the specific type of instrument or meter. For example:

- A — Ammeter
- AH — Ampere-hour
- DB — Decibel
- F — Frequency
- G — Galvanometer
- MA — Milliammeter
- PF — Power factor
- TT — Total time
- UA — Microammeter
- V — Voltmeter
- VA — Volt-ammeter
- VO — Volt-ohm
- VU — Volume unit
- W — Watt
- WH — Watt-hour

(a) Meter shunt

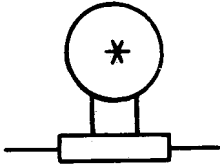

(b) Nonlocking lever-type key

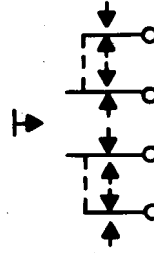

4.29 Interrupters

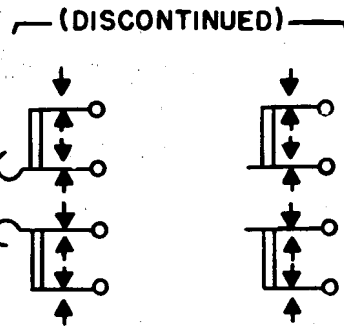
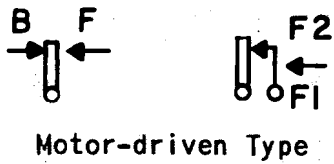

(a) Ringing interrupter

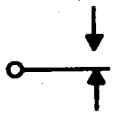

(c) Half of lever-type key normally operated

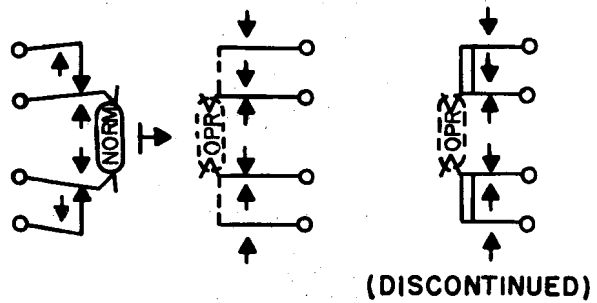

4.30 Jacks [See 4.13(c)]

4.31 Keys

(a) Locking lever-type key

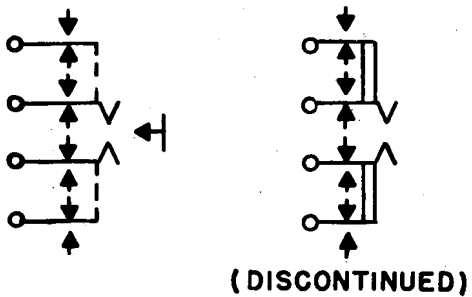

(d) Jack-type key

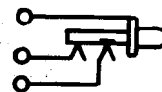

(e) Plunger-type key

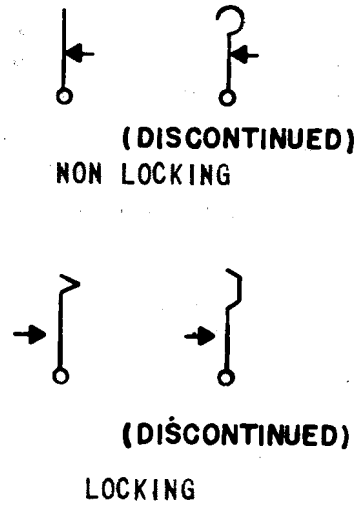

(f) Telegraph-type key



(g) Selector-type key

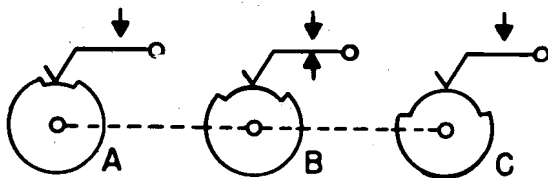

(a) Lever-type keytop diagrams (See note)

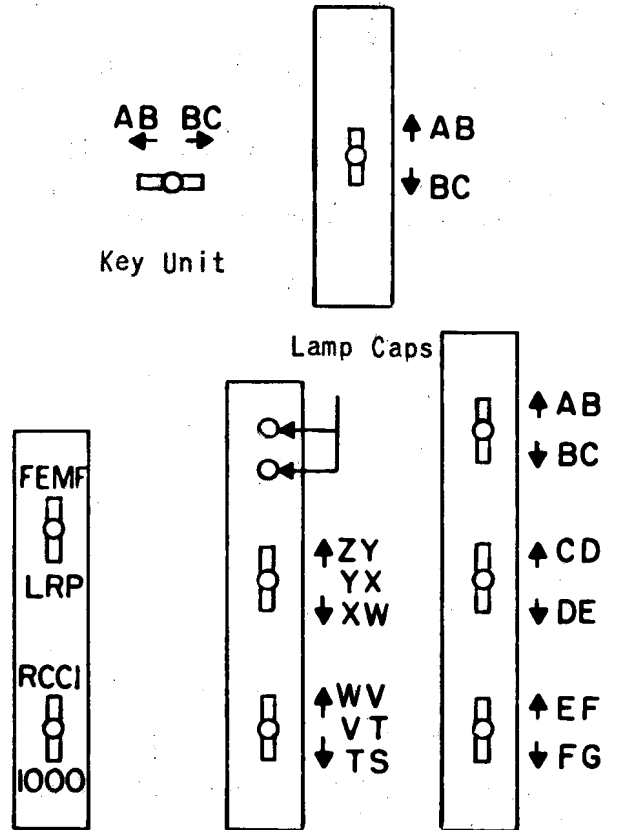

(b) Push-button-type keytop diagrams (See note)

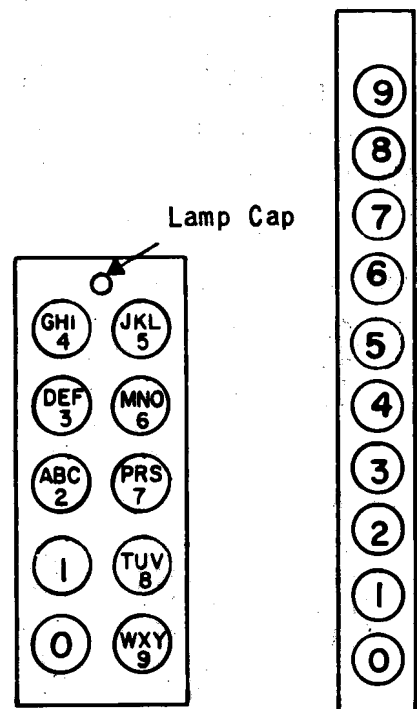

4.32 Keytop Diagrams

Note: Show designations within keytops only when engraved.

(c) Turn button-type keytop diagrams

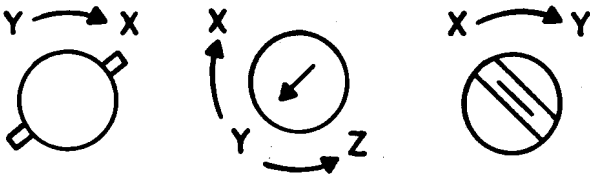

(d) Selector switch-type keytop diagram (other than Western Electric Company, keys)

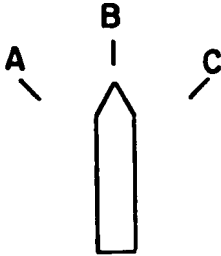

4.33 Lamps

(a) Single-filament ballast or resistance lamp

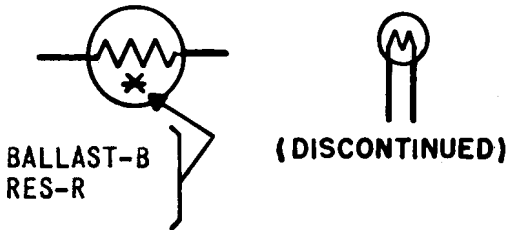

(b) Double-filament ballast or resistance lamp

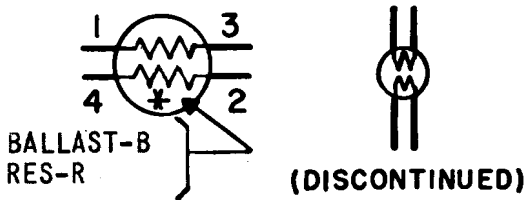

(c) Illuminating-type lamp



(d) Switchboard-type lamp



(e) Glow-type lamp

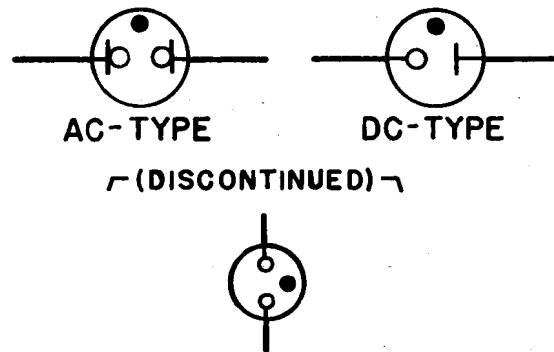

4.34 Loudspeaker, Horn, Howler, Telephone Receiver (Tone Ringer)

(a) General

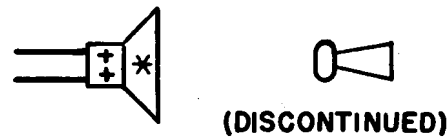

(b) If specific identification of loudspeaker parts is required, the following letter combinations may be added. The \* and ‡ are not part of the symbol.

- ‡EM — Electromagnetic with moving coil (moving coil leads should be identified)
- ‡EMN — Electromagnetic with moving coil and neutralizing winding (moving coil leads should be identified)
- \*HN — Horn
- \*HW — Howler
- \*LS — Loudspeaker
- ‡MG — Magnetic armature
- ‡PM — Permanent magnet with moving coil
- \*TR — Telephone receiver (tone-ringer)

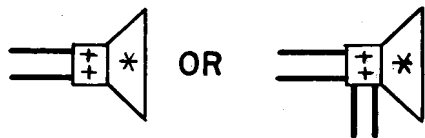

(DISCONTINUED)

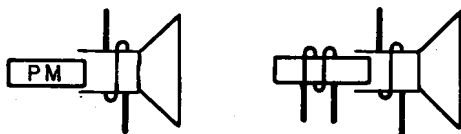

4.35 *Message Register*



(DISCONTINUED)

4.36 *Meters* (See 4.28)

4.37 *Microphone*



4.38 *Motors*

(a) DC shunt motor

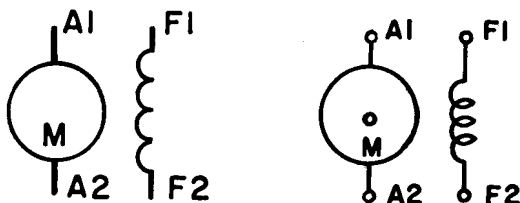

(DISCONTINUED)

(b) AC induction-type motor

(1) 2-phase

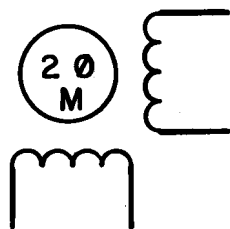

(2) 3-phase

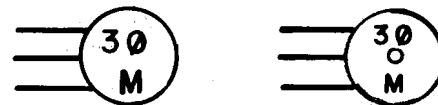

(DISCONTINUED)

4.39 *Networks*

(a) Typical networks

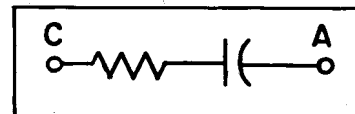

(b) Networks when used as contact protection

*Note:* A number, starting with 1, is assigned for each different coded network used in the circuit. The same number is used for each network of the same code used in the circuit. No number is used in connection with built-up type contact protection. The definition of the number is contained in a table on the circuit drawing.

(1) 2- or 4-terminal network when used as contact protection

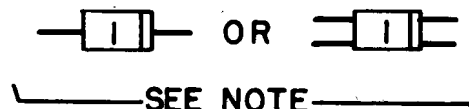

SEE NOTE

(DISCONTINUED)

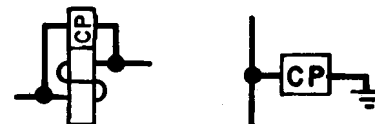

(2) 3-terminal network when used as contact protection

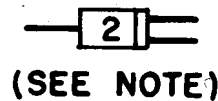

(SEE NOTE)

4.40 *Plugs* (See 4.13)

4.41 Potentiometers

Note: CW indicates position of adjustable contact at the limit of clockwise travel viewed from knob or actuator end, unless otherwise indicated.

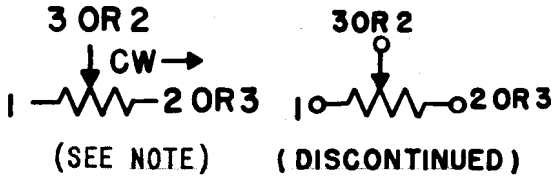

4.42 Protector Blocks



4.43 Receivers (Also see 4.24, 4.25, and 4.34)

(a) General

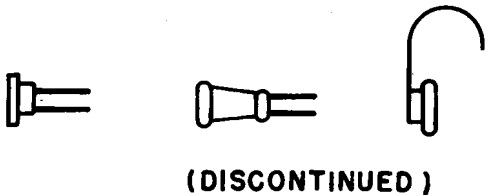

(b) Double headset receiver

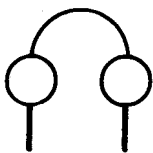

(c) Single headset receiver

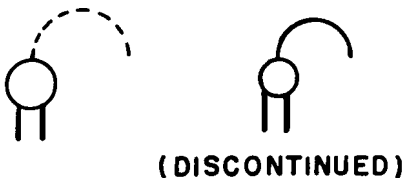

4.44 Receptacles [See 4.13(d)]

4.45 Rectifier, Metallic (See 4.68)

4.46 Regulator

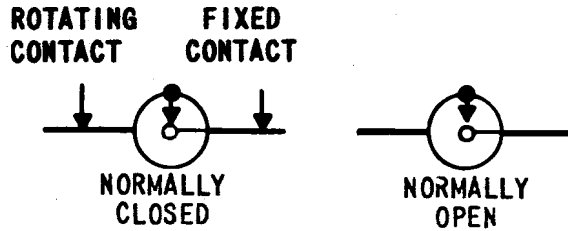

4.47 Relays (Also see 4.14)

Note: When relay symbols, showing top and bottom springs are rotated 90° on a drawing, the word top shall be placed in appropriate position.

Show abbreviations as follows for specific operating features, if required. On polarized relays used in telegraph circuits, the designations S and M indicate the "spacing" and "marking" contacts, respectively.

- AC — Alternating current
- D — Differential
- DB — Double-biased — biased in both directions
- DP — Dashpot
- EP — Electrically polarized
- FO — Fast operate
- FR — Fast release
- MG — Marginal
- NB — No bias
- NR — Nonreactance
- P — Magnetically polarized using biasing spring or having magnetic bias
- SA — Slow acting
- SO — Slow operate
- SR — Slow release
- TS — Two-step

(a) Single-wound relay with make contact

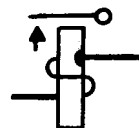



(b) Double-wound relay with break and make-before-break contacts

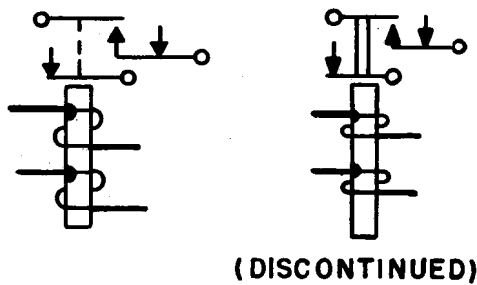

(c) Relay with noninductive winding and transfer contacts

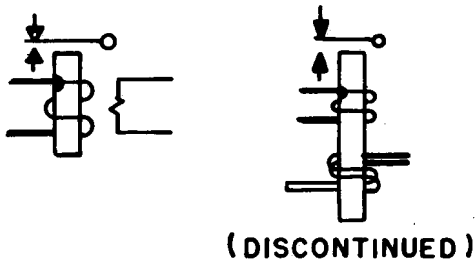

(d) Relay with preliminary make contacts

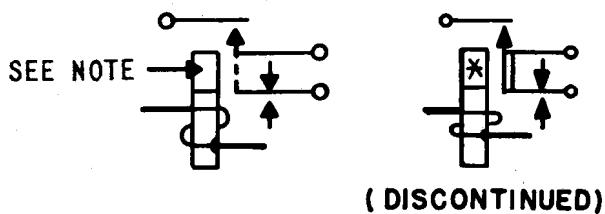

(e) Relay in normally operated position

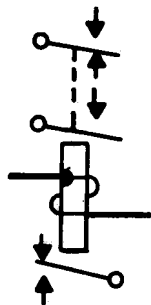

(f) Multicontact relay

(1) Nonsplit multicontact relay

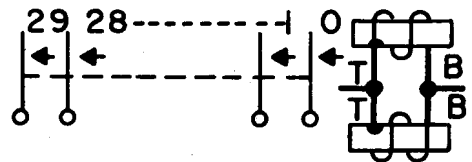

(DISCONTINUED)

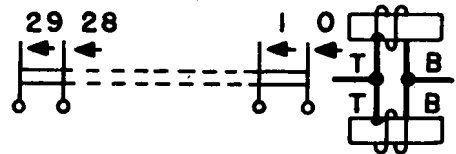

(2) Split multicontact relay

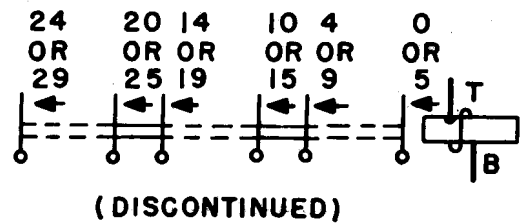
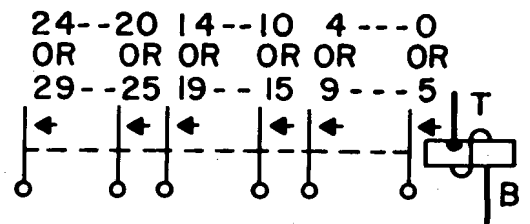

(g) Mechanically locking and electrically releasing relay

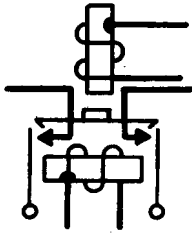

(h) Solenoid-type relay [See 4.14 (b)]

(i) Polarized telegraph-type relay

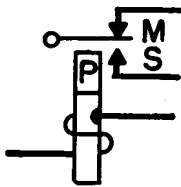

(j) Double contact-type relay

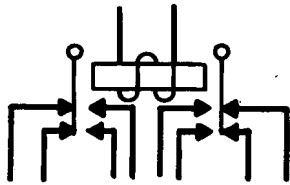

(k) Thermal delay relay (Also see 4.59)

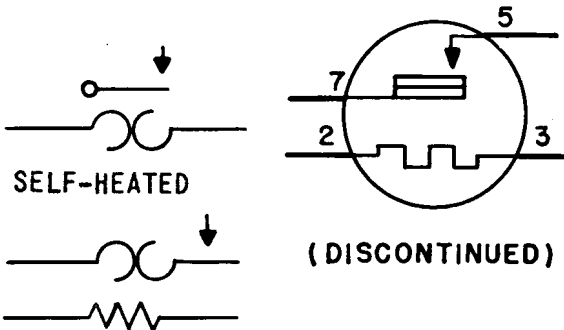

(l) Thermostat-type relay

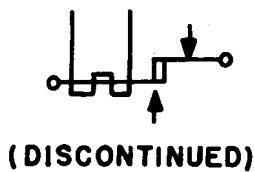

(m) Ammeter-type relay

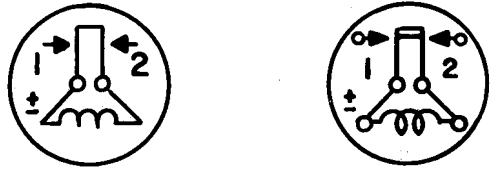

(DISCONTINUED)

(n) Sensitrol-type relay

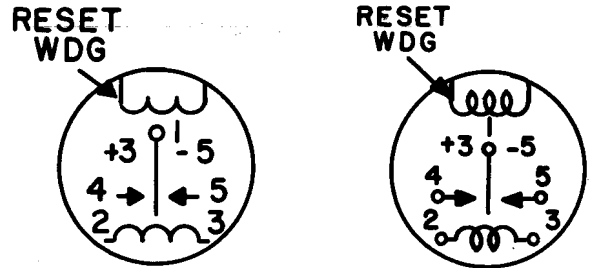

(DISCONTINUED)

(o) Mercury contact-type relay

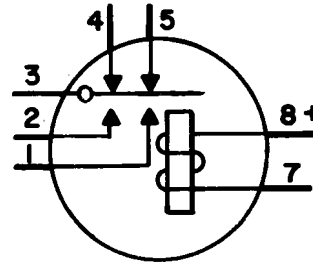

(p) Voltage-type relay

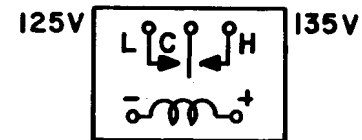
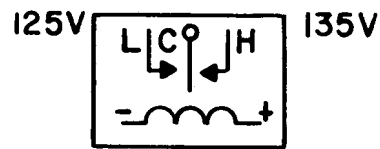

(DISCONTINUED)

4.48 Resistors (Also see 4.41)

(a) Resistor with one winding



(b) Resistor with two windings and having one terminal common to both windings



(c) Relay spool-type resistor

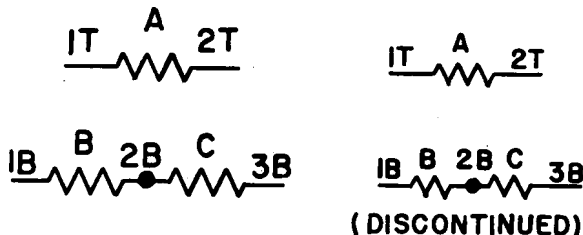

(d) Tapped windings



4.49 Rheostat or Adjustable Resistor

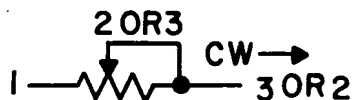

4.50 Ringer (Also see 4.05)

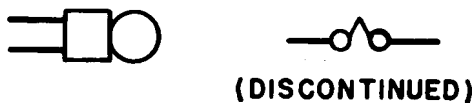

4.51 Selectors

(a) 10-terminal rotary-type selector

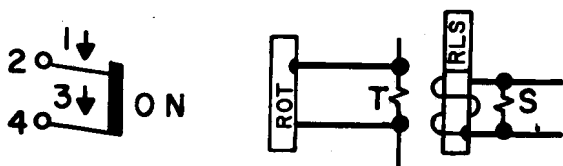
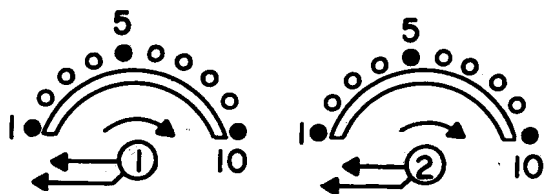

(b) 22-terminal rotary-type selector

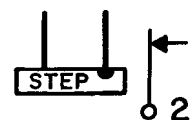
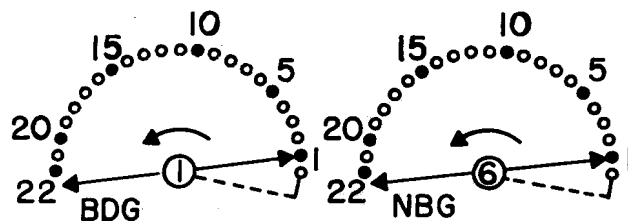

(c) 44-terminal rotary-type selector

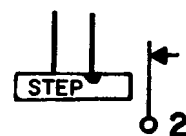
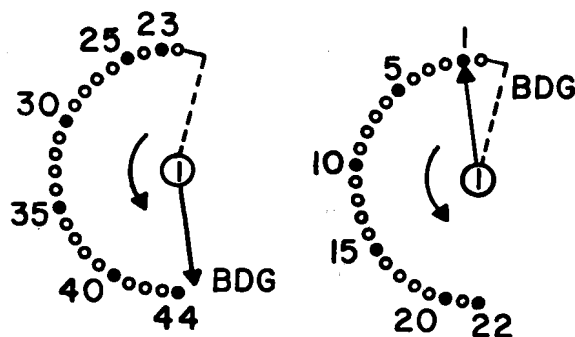

4.52 Signals



4.53 Sounders

(a) Chime, tone bar, etc, type sounder

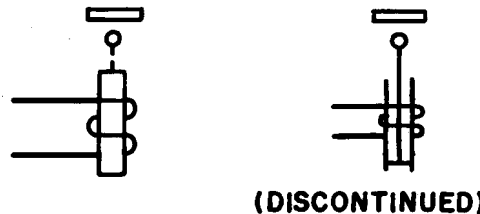

(b) Telegraph-type sounder

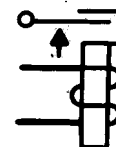

4.54 Switches

(a) Step-by-step system selector-type switches

(1) Wipers and banks

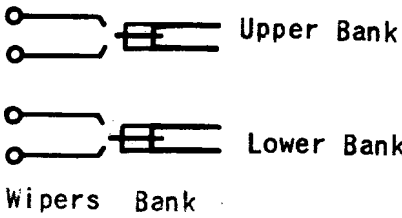

(2) Vertical commutator and wiper

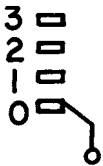

(3) Normal post springs

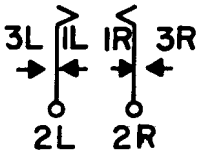

(4) Magnets

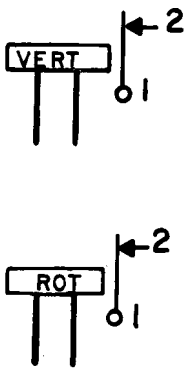

(5) Vertical off-normal springs

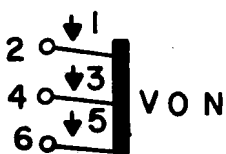

(6) Rotary off-normal springs

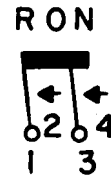

(7) 11th rotary step springs

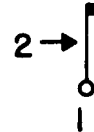

(b) Sequence-type switches

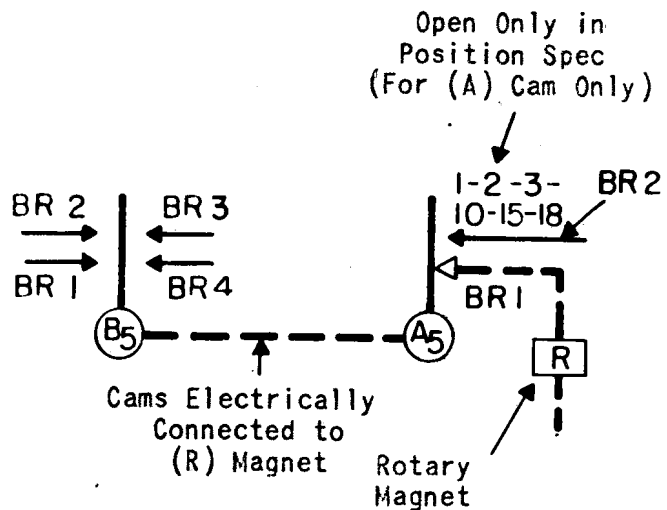
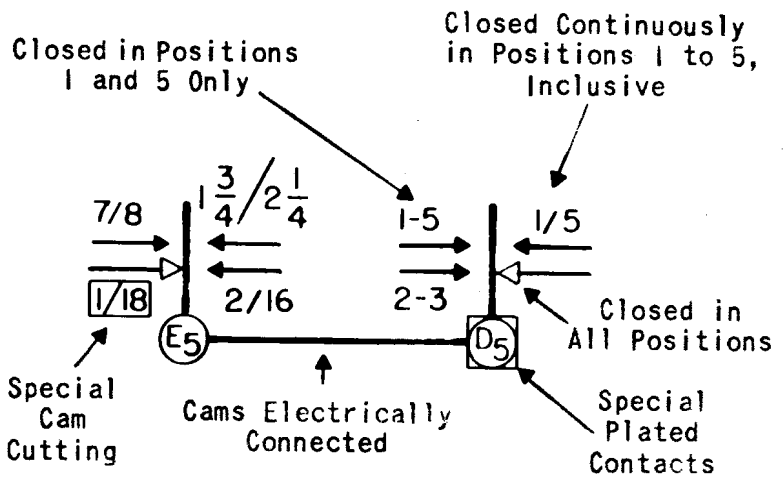

(c) Knife, rotary, snap, toggle, or tumbler-type switches

- (1) Single-pole, single-throw switch

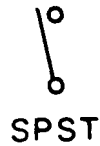

- (2) Single-pole, double-throw switch

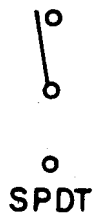

- (3) Double-pole, single-throw switch



- (4) Double-pole, double-throw switch

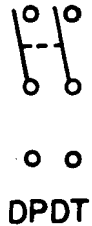

(d) Cover- or door-type switches

- (1) Cover or door closed, switch opens when cover or door opens



- (2) Cover or door closed, switch closes when cover or door opens



(e) Crossbar selector-type switch

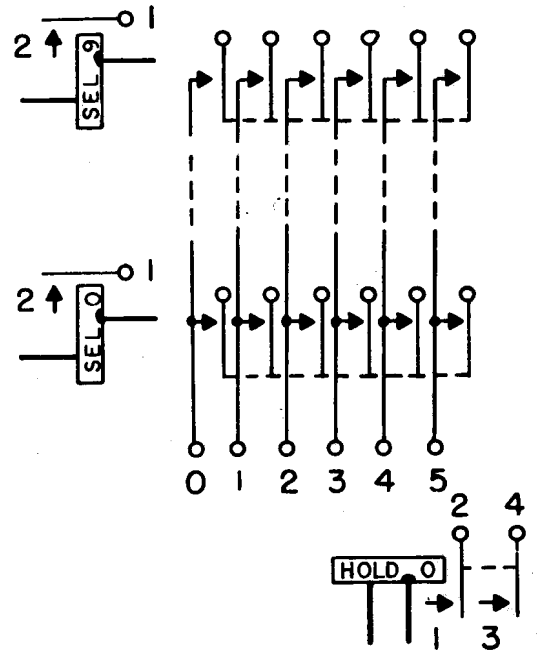

DISCONTINUED

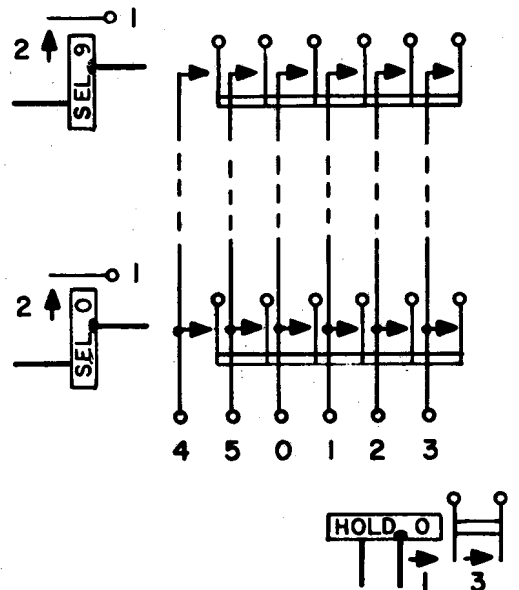

Notes:

- A. SEL magnets may be placed on right or left of contacts as best suits wiring condition.

B. Contacts on SEL or HOLD magnets may be shown at either end of magnet core to suit schematic conditions.

C. HOLD magnets may be shown under SEL magnets where wiring from contact terminals is run vertically.

(f) Rotary-type (high voltage)

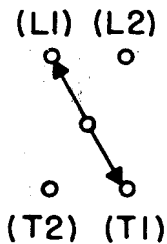

(1) Application

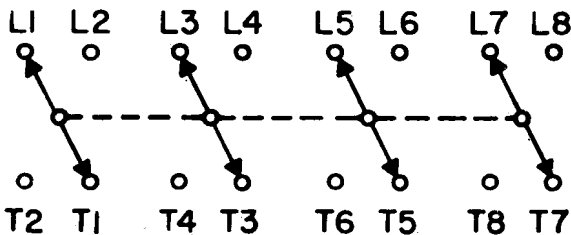

(g) Selector-type switches

(VIEWED FROM WIRING SIDE, UNLESS OTHERWISE INDICATED)

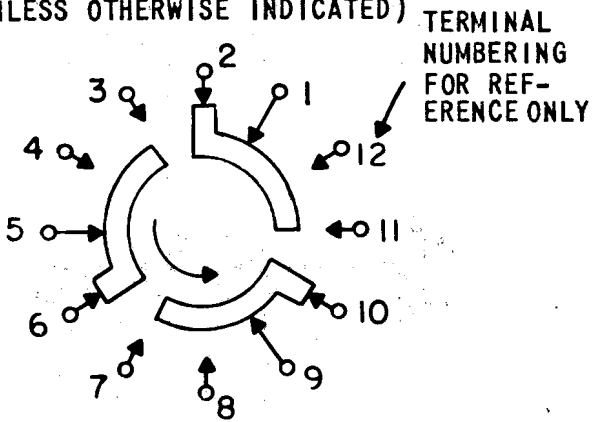

TERMINAL NUMBERING FOR REFERENCE ONLY

OR

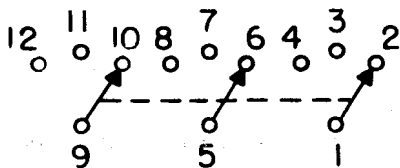

NUMBERS IN BOTH FIGURES CORRESPOND

4.55 Switchhook

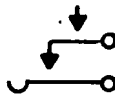

4.56 Terminals

(a) Apparatus terminal



(b) Terminal strip or terminal punching



(c) Cross-connecting terminal



(d) Coaxial terminal



4.57 Terminal Strip

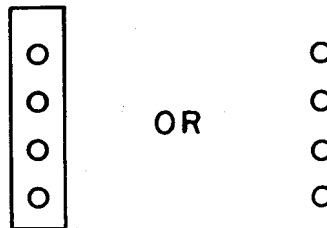

4.58 Test Point

TEST POINTS SUCH AS A JACK, TERMINAL, ETC, (DISCONTINUED) SHALL BE DESIGNATED AND CODED

T.P.



4.59 Thermal Devices

(a) External heater unit [See 4.47(k)]

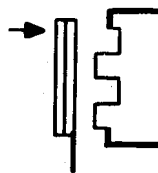

(DISCONTINUED)

(b) Integral heater unit

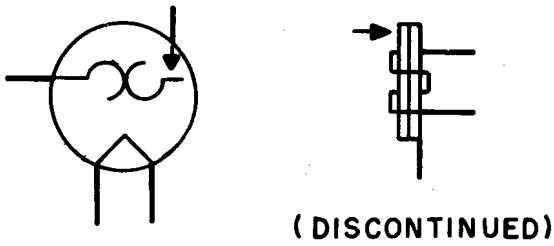

(b) Indirectly heated thermocouple

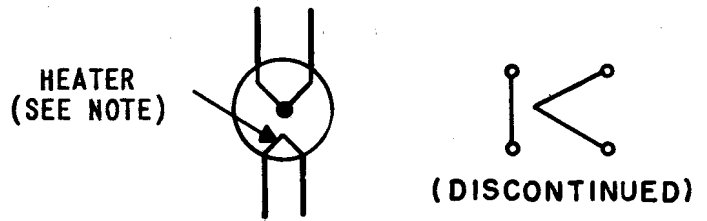

4.62 *Timer*

(c) Self-heated unit [See 4.47 (k)]



(DISCONTINUED)

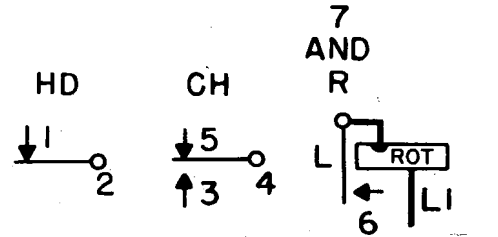

(DISCONTINUED)

4.60 *Thermistors*

(a) Directly heated thermistor

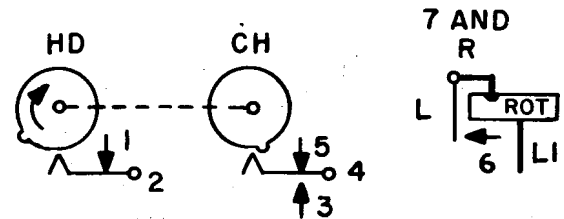
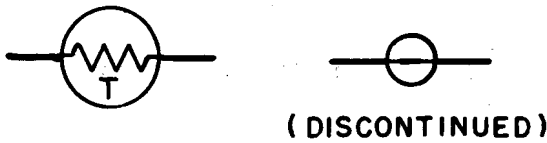

4.63 *Tone Alternator*

(b) Indirectly heated thermistor

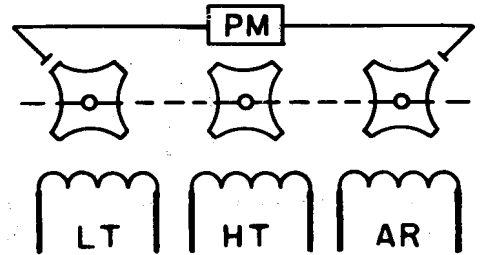
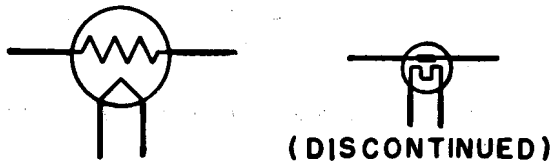

(DISCONTINUED)

4.61 *Thermocouples*

*Note:* Explanatory words and arrows are not a part of the symbols shown.

(a) Directly heated thermocouple

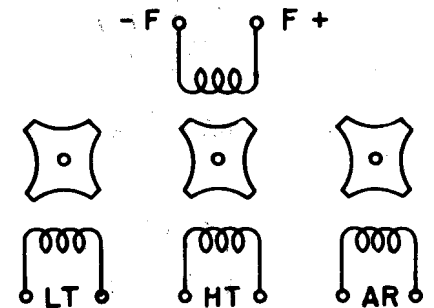
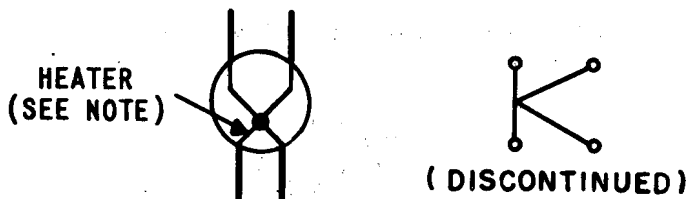

4.64 *Transformer* (See 4.12)

4.65 *Transistor (Semiconductor Devices)* (Also see 2.08 and 4.17)

(a) P-N-P transistor (also P-N-I-P transistor if leaving out the intrinsic region does not result in ambiguity)

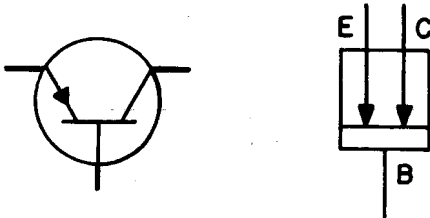

(DISCONTINUED)

(b) N-P-N transistor (also N-P-I-N transistor if leaving out the intrinsic region does not result in ambiguity)

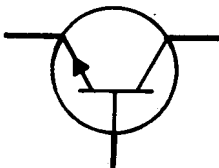

(c) P-N unijunction transistor (sometimes called double base diode or filamentary transistor)

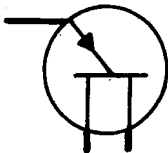

(d) N-P unijunction transistor (sometimes called double base diode or filamentary transistor)

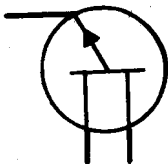

(e) P-type field-effects transistor

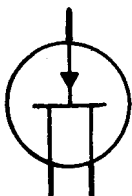

(f) N-type field-effects transistor

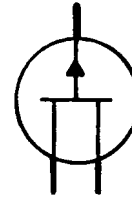

(g) P-N-P-N transistor (hook or conjugate-emitter connection)

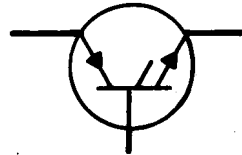

(h) N-P-N-P transistor (hook or conjugate-emitter connection)

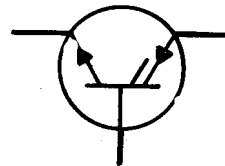

(i) P-N-P-N transistor (remote base connection)

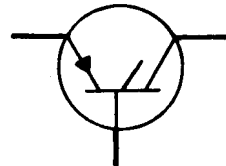

(j) N-P-N-P transistor (remote base connection)

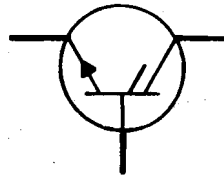

(k) P-N-P-N transistor without base connection

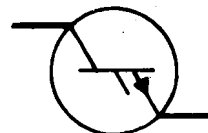



(l) P-N-P tetrode

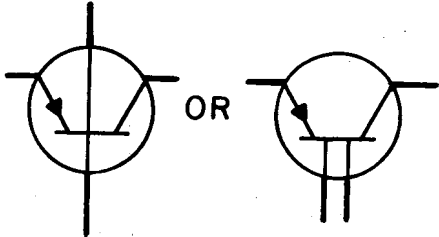

(m) N-P-N tetrode

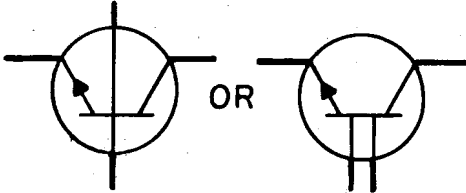

(n) P-N-I-P transistor with ohmic connection to the intrinsic region

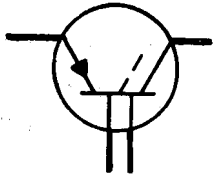

(o) N-P-I-N transistor with ohmic connection to the intrinsic region

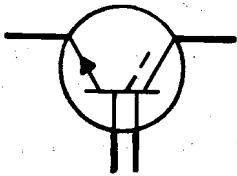

(p) P-N-I-N transistor with ohmic connection to the intrinsic region

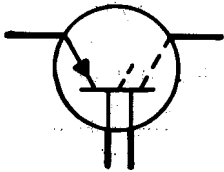

(q) N-P-I-P transistor with ohmic connection to the intrinsic region

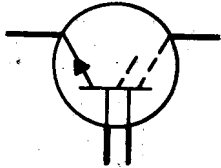

4.66 Transmitters

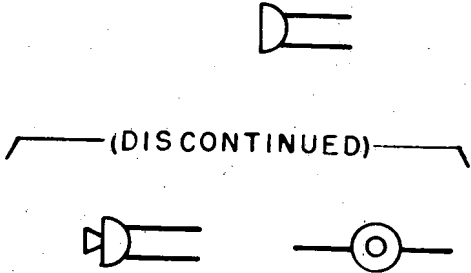

4.67 Tubes, Electron

(a) Cathode-ray tube

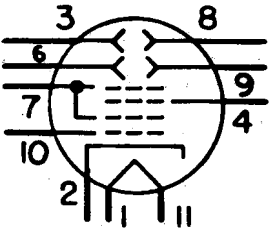

(b) Cold cathode tube

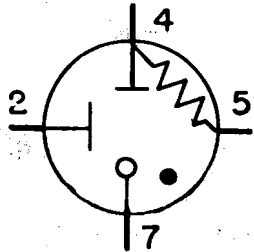

(DISCONTINUED)

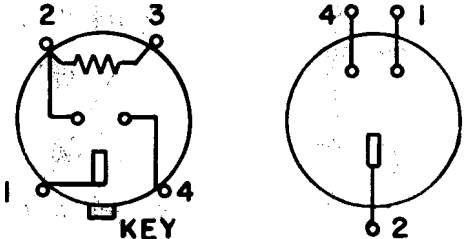

(c) Pentode tube

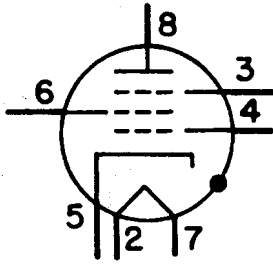

(d) Twin-triode tubes

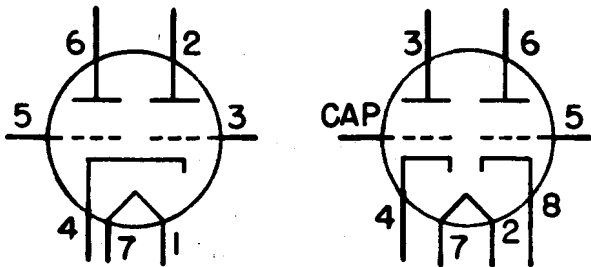

(e) Tube, showing shield sleeve

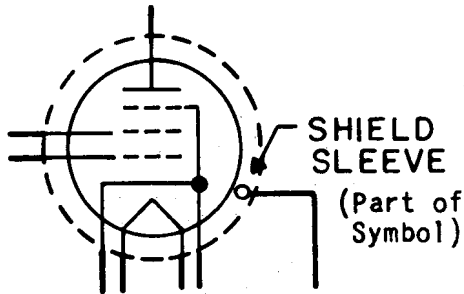

4.68 Varistors or Metallic Rectifiers (Also see Diodes 4.17)

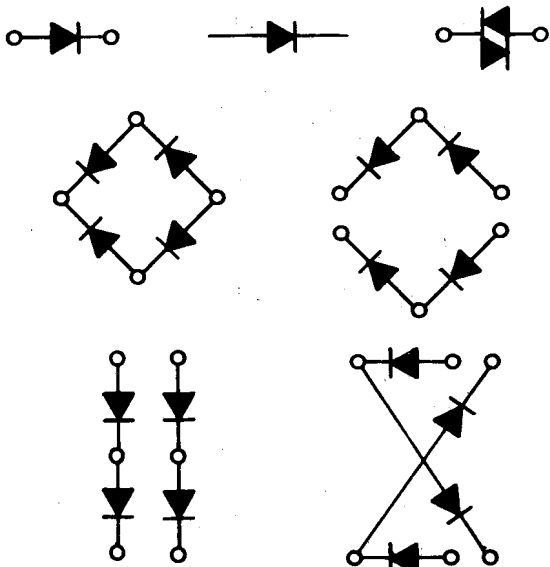

**Note:** Arrow indicates the direction of low resistance to positive current flow.

4.69 Vibrator

(a) Typical shunt drive (contacts as required)

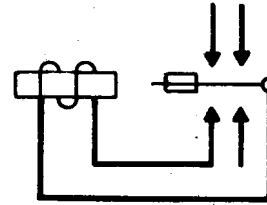

(DISCONTINUED)

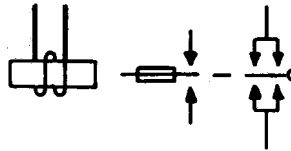

(b) Typical separate drive (contacts as required)

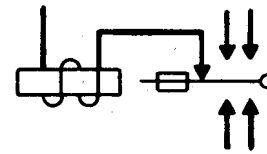

5. COAXIAL AND WAVEGUIDE SYMBOLS (Also see 4.13)

5.01 Transmission Path

**Note:** A single line represents a transmission path and extends for its entire length. The recognition symbol is used once, either at the beginning, end, or middle of the path unless needed at additional points for clarity. Continuity of all conductors in the path is understood, unless the schematic drawing carries a note to the contrary.

(a) Coaxial



(b) Waveguide, circular



(c) Waveguide, rectangular

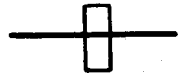

(d) Waveguide, ridged

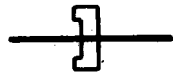

(e) Connectors (See 4.13)

5.02 Antenna — General

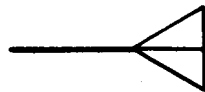

5.03 Attenuator



5.04 Coupling By Loop

(a) Coupling by loop to space



(b) Coupling by loop to guided transmission path



(c) Application: Coupling by loop from coaxial to circular waveguide

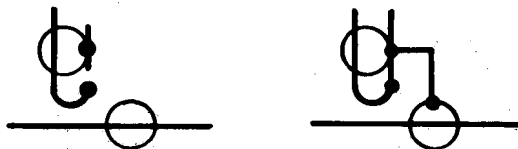

(DISCONTINUED)

5.05 Coupling By Aperture With an Opening of Less Than Full Waveguide Size

(a) Designate E, H, or HE.

(1) E indicates that the physical plane of the aperture is perpendicular to the transverse component of the major E lines.

(2) H indicates that the physical plane of the aperture is parallel to the transverse component of the major E lines.

(3) HE indicates coupling by all other kinds of apertures.

(4) Transmission loss may be indicated.

(b) Coupling by aperture to space

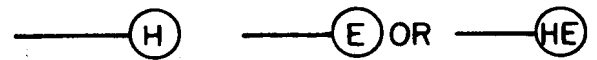

(c) Four ends of transmission path available

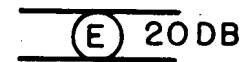

(d) Three ends of transmission path available

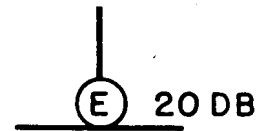

(e) Two ends of transmission path available

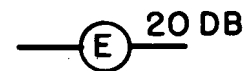

5.06 Coupling By Probe (See 5.13)

(a) Coupling by probe to space



(b) Coupling by probe to a guided transmission path



(c) **Application:** Coupling by probe from coaxial to rectangular waveguide

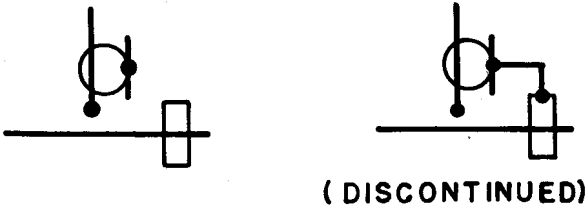

5.07 **Directional Coupler**

(a) General



- (1) Arrows indicate direction of power flow.
- (2) Number of coupling paths may be indicated.
- (3) Transmission loss may be indicated.

(b) Aperture coupling, designate E, H, or HE



(c) Coaxial loop coupling, 30-db attenuation



(d) Coaxial probe coupling, 30-db attenuation



(e) Resistance coupling

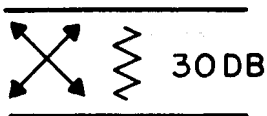

5.08 **Discontinuity**

(a) To be drawn for a component that exhibits the properties of one of the types of circuit elements throughout the frequency range of interest.

(b) Equivalent series element - general

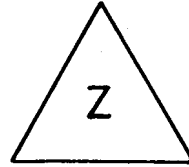

(1) Capacitive reactance

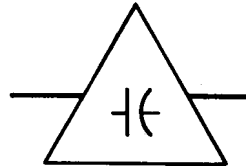

(2) Inductive reactance

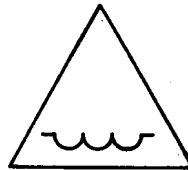

(DISCONTINUED)

(3) L-C circuit with infinite reactance at resonance

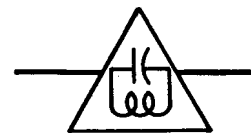
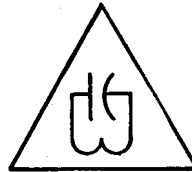

(DISCONTINUED)

(4) L-C circuit with zero reactance at resonance

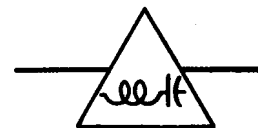
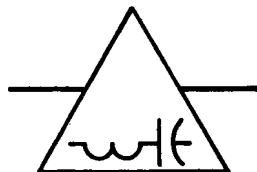

(DISCONTINUED)

(5) Resistance

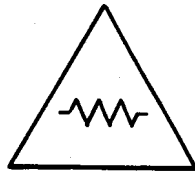

(c) Equivalent shunt element - general

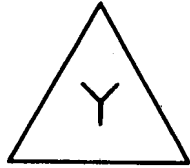

(1) Capacitive susceptance

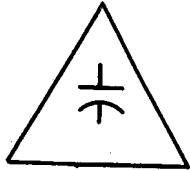

(2) Conductance

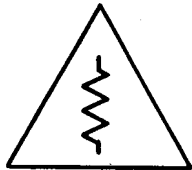

(3) Inductive susceptance



(4) L-C circuit with infinite susceptance at resonance



(5) L-C circuit with zero susceptance at resonance

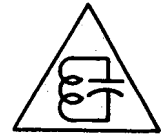
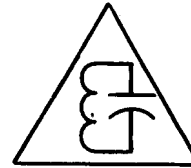

(DISCONTINUED)

5.09 Junction (Aperture Fully Open)

(a) Tee or wye

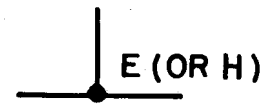

(b) Hybrid

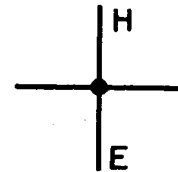

(c) Application: Waveguide and coaxial couplings

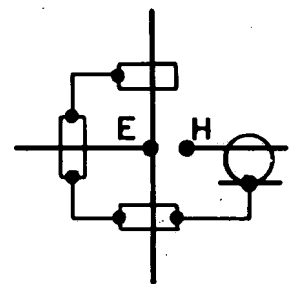
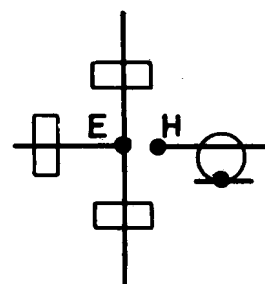

(DISCONTINUED)

(d) Hybrid, circular

(1) Letter inside circle indicates plane of the field in the ring is normal to the axis of the ring.

(2) Critical distances should be labeled in terms of guide wavelengths.

(e) *Application:* 5-arm circular hybrid

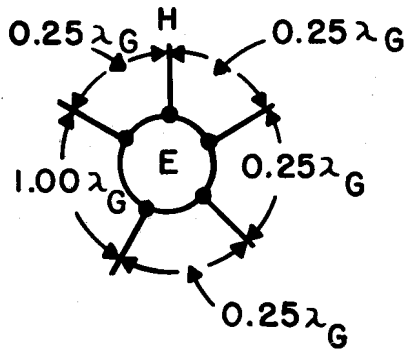

5.10 *Mode Suppression*



5.11 *Mode Transducer*



(a) Applications

(1) Transducer from rectangular to circular waveguide

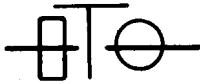

(2) Transducer from rectangular waveguide to coaxial with mode suppression

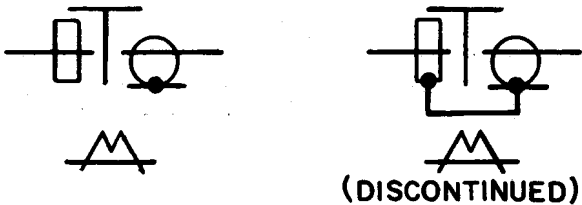

5.12 *Movable*



5.13 *Open* (See 5.06)



5.14 *Phase Shifter*

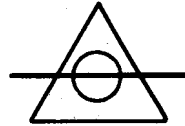

5.15 *Resonator* (Excluding Piezoelectric and Magnetostriction Devices)

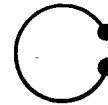

(a) Applications

(1) Resonator coupled by an aperture to rectangular waveguide and by a loop to a coaxial. With mode suppression.

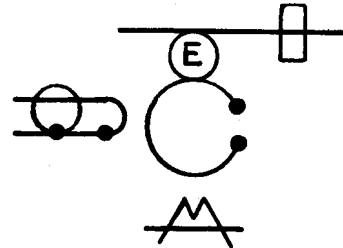

(2) Resonator coupled by a probe to a coaxial. With tuning. Variable Q.

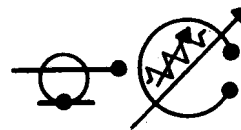

5.16 *Rotation*

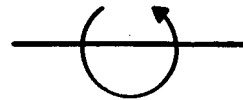

5.17 *Short* (Transmission Path Terminated in a Short)

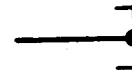

(a) Movable short

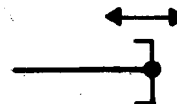

5.18 **Switch** (Any Number of Transmission Paths May Be Used)

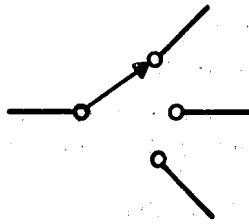

5.19 **Transformation For Tapers and Step Transformers Without Mode Change**

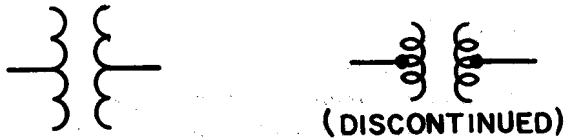

(a) **Application:** Transformer with mode suppression

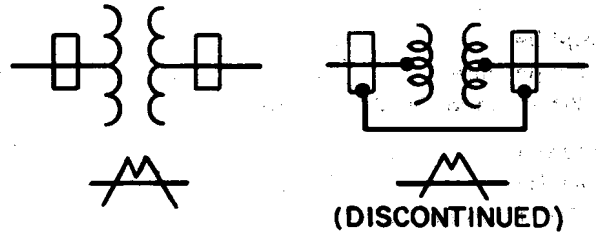

**REASON FOR REISSUE**

1. This section was completely revised to list the various components required in order to assemble the circuit symbols used on attached-contact and detached-contact schematic drawings. As far as practicable, these symbols are identical with those approved for electrical diagrams by the American Standards Association and include those symbols peculiar to the Bell System.

## ALPHABETICAL INDEX

	Page		Page
Amplifier . . . . .	9	Clock, Electric . . . . .	11
Single line . . . . .	9	Clutch Magnets . . . . .	11
Where more leads are shown . . . . .	9	Coaxial and Waveguide Symbols . . . . .	34
Antenna . . . . .	9,35	Coils, Autotransformer, Induction Coil, Inductor, Repeating Coil, Transformer . . . . .	2,11
Aerial . . . . .	9	Autotransformer . . . . .	2,11
Counterpoise . . . . .	9	Induction coil, repeating coil, transformer . . . . .	2,11
Loop . . . . .	9	Inductor . . . . .	2,13
Associated Conductors . . . . .	7	Coils, Heat . . . . .	19
Cable, coaxial . . . . .	8,34	Alarm-type heat coil on bus bar . . . . .	19
Cable, switchboard . . . . .	8	Protector-type heat coil . . . . .	19
Cross-connection wires . . . . .	7	Components, Symbol . . . . .	2
Leads requiring segregation for crosstalk control, etc . . . . .	8	Conductors, Associated . . . . .	7
Leads run from terminal to terminal . . . . .	8	Connectors . . . . .	14
Local cable or loose wiring . . . . .	8	Coaxial connectors . . . . .	14
Paired twisted wires . . . . .	7	Connectors commonly used for power supply (convenience outlets and mating connectors) . . . . .	15
Quad - (two pairs twisted) . . . . .	7	Cord tip-type connector . . . . .	16
Triple twisted wires . . . . .	7	Separable connectors showing female and male contacts engaged . . . . .	14
4-wire twist . . . . .	7	Switchboard-type connectors (jacks and plugs) . . . . .	14
Attenuator . . . . .	35	Contact . . . . .	2
Autotransformer . . . . .	10,11,12	Fixed, adjustable, or sliding contacts . . . . .	2
Batteries and Potential Supply . . . . .	10	Moving contact or armature for relays, nonlocking keys, etc . . . . .	2
CEMF cells . . . . .	10	Moving contact for locking keys, jacks, etc . . . . .	2
One cell . . . . .	10	Normally closed and normally open contact . . . . .	2
Multicell battery . . . . .	10	Contactors . . . . .	16
Potential supply . . . . .	10	Relay (armature) -type . . . . .	16
Solar battery . . . . .	10	Solenoid-type . . . . .	17
Bells . . . . .	10	Core . . . . .	2
AC bell . . . . .	10	Core for relays, magnets, etc . . . . .	2
AC-DC bell . . . . .	10	Core, magnetic (general) . . . . .	2
DC bell . . . . .	10	Counterpoise . . . . .	9
Binding Post . . . . .	10	Coupling . . . . .	4
Buzzers . . . . .	10	Coupling by aperture with an opening of less than full waveguide size . . . . .	35
AC buzzer . . . . .	10	Coupling by aperture to space . . . . .	35
AC-DC buzzer . . . . .	10	Designate E, H, or HE . . . . .	36
DC buzzer . . . . .	10	Four ends of transmission path available . . . . .	35
Cable . . . . .	8	Three ends of transmission path available . . . . .	35
Capacitors . . . . .	11	Two ends of transmission path available . . . . .	35
Differential variable capacitor . . . . .	11		
Electrolytic capacitor . . . . .	11		
Fixed capacitor . . . . .	11		
Variable or adjustable capacitor . . . . .	11		
Circuit Breaker . . . . .	11		
Application . . . . .	11		
Toggle switch type circuit breaker . . . . .	11		



	Page		Page
Coupling by loop . . . . .	35	Handsets . . . . .	19
Coupling by loop to space . . . . .	35	3-conductor handset . . . . .	19
Coupling by loop to guided transmission path . . . . .	35	4-conductor handset . . . . .	19
Application: Coupling by loop from coaxial to circular waveguide . . . . .	35	4-conductor handset with push-to-talk switch . . . . .	19
Coupling by probe . . . . .	35	Headset, Operator . . . . .	19,24
Coupling by probe to space . . . . .	35	Heat Coils . . . . .	19
Coupling by probe to a guided transmission path . . . . .	35	Alarm-type heat coil on bus bar . . . . .	19
Application: Coupling by probe from coaxial to rectangular waveguide . . . . .	36	Protector-type heat coil . . . . .	19
Cross-connection Wires . . . . .	7	Heating Resistor . . . . .	2
Crystal Units . . . . .	17	Horn or Howler . . . . .	19,22
Detached-contact Schematic Symbols . . . . .	6	Inductance . . . . .	2
Break . . . . .	6	Induction Coil . . . . .	2,12
Core and winding . . . . .	6	Inductors . . . . .	2,13
Make . . . . .	6	Instruments and meters . . . . .	19
Dials . . . . .	17	Meter shunt . . . . .	20
Diodes . . . . .	17,32	Interrupters . . . . .	20
Directional Coupler . . . . .	36	Ring ing interrupter . . . . .	20
Aperture coupling, designate E, H, or HE . . . . .	36	Jacks . . . . .	14,20
Coaxial loop coupling, 30-db attenuation . . . . .	36	Junction (aperture fully open) . . . . .	37
Coaxial probe coupling, 30-db attenuation . . . . .	36	Application: waveguide and coaxial couplings . . . . .	37
General . . . . .	36	Application: 5-arm circular hybrid . . . . .	38
Resistance coupling . . . . .	36	Hybrid . . . . .	37
Discontinuity . . . . .	36	Hybrid, circular . . . . .	37
Equivalent series element - general . . . . .	36	Tee or Wye . . . . .	37
Equivalent shunt element - general . . . . .	37	Keys . . . . .	2,20
Drops . . . . .	17	Half of lever-type key normally operated . . . . .	20
Electrically restored drop . . . . .	17	Jack-type key . . . . .	20
Manually restored drop . . . . .	17	Locking lever-type key . . . . .	20
Electromagnet . . . . .	17	Nonlocking lever-type key . . . . .	20
Electron Tubes . . . . .	3,33	Plunger-type key . . . . .	21
Engine-Generator Set . . . . .	18	Selector-type key . . . . .	21
Fuses . . . . .	18	Telegraph-type key . . . . .	21
Alarm-type fuse . . . . .	18	Keypop Diagrams . . . . .	21
Alarm-type fuse on bus bar . . . . .	18	Lever-type keytop diagrams . . . . .	21
Fuse (no alarm) . . . . .	18	Push-button-type keytop diagrams . . . . .	21
Fuse in safety-type holder . . . . .	18	Selector switch-type keytop diagram . . . . .	22
Generator, Hand-type . . . . .	18	Turn button-type keytop diagrams . . . . .	22
Ground Symbols . . . . .	18	Lamps . . . . .	22
Chassis or frame ground . . . . .	18	Double-filament ballast or resistance lamp . . . . .	22
Earth ground . . . . .	18	Glow-type lamp . . . . .	22
		Illuminating-type lamp . . . . .	22
		Single-filament ballast or resistance lamp . . . . .	22
		Switchboard-type lamp . . . . .	22

	Page		Page
Line Symbols . . . . .	7	Receptacles . . . . .	15,24
Loudspeaker, Horn, Howler, Telephone		Rectifier, Metallic . . . . .	24,34
Receiver (tone ringer) . . . . .	22	Regulator . . . . .	24
General . . . . .	22	Relays . . . . .	2,16,24
Identification of loudspeaker parts . . . . .	22	Ammeter-type relay . . . . .	26
Message Register . . . . .	23	Double contact-type relay . . . . .	26
Meters . . . . .	19,23	Double-wound relay with break and make-before-break contacts . . . . .	25
Microphone . . . . .	23	Mechanically locking and electrically releasing relay . . . . .	26
Mode Suppression . . . . .	38	Mercury contact-type relay . . . . .	26
Mode Transducer . . . . .	38	Multicontact relay . . . . .	25
Applications . . . . .	38	Polarized telegraph-type relay . . . . .	26
Motors . . . . .	23	Relay in normally operated position . . . . .	25
AC induction-type motor . . . . .	23	Relay with noninductive winding and transfer contacts . . . . .	25
DC shunt motor . . . . .	23	Relay with preliminary make contacts . . . . .	25
Movable (coaxial and waveguide symbol) . . . . .	38	Sensitrol-type relay . . . . .	26
Networks . . . . .	23	Single-wound relay with make contact . . . . .	24
Networks when used as contact protection . . . . .	23	Solenoid-type relay . . . . .	17,26
Typical networks . . . . .	23	Thermal delay relay . . . . .	26
Open (coaxial and waveguide) . . . . .	36,37	Thermostat-type relay . . . . .	26
Path, Transmission (coaxial and waveguide) . . . . .	34	Voltage-type relay . . . . .	26
Coaxial, cable . . . . .	8,34	Repeating Coil . . . . .	2,12,13
Connectors . . . . .	14,35	Resistor, heating . . . . .	2
Waveguide, circular . . . . .	34	Resistors . . . . .	26
Waveguide, rectangular . . . . .	35	Relay spool-type resistor . . . . .	27
Waveguide, ridged . . . . .	35	Resistor with one winding . . . . .	26
Paths and Path Junctions . . . . .	9	Resistor with two windings and having one terminal common to both windings . . . . .	27
Crossed paths . . . . .	9	Tapped windings . . . . .	27
Joined paths . . . . .	9	Resonator (excluding piezoelectric and magnetostriction devices) . . . . .	38
Multiple connection . . . . .	9	Applications . . . . .	38
Optional or alternate paths . . . . .	9	Rheostat or Adjustable Resistor . . . . .	27
Spliced wires . . . . .	9	Ringer . . . . .	10,27
Phase Shifter . . . . .	38	Rotation (coaxial and waveguide symbol) . . . . .	38
Piezoelectric, Crystal Unit . . . . .	17	Saturable Reactor . . . . .	13
Plugs . . . . .	14,23	Selectors . . . . .	27
Potentiometers . . . . .	24	10-terminal rotary-type selector . . . . .	27
Primary Wiring Symbols . . . . .	7	22-terminal rotary-type selector . . . . .	27
Protector Blocks . . . . .	24	44-terminal rotary-type selector . . . . .	27
Receivers . . . . .	19,22,24	Semiconductor Devices . . . . .	2,17,32
Double headset receiver . . . . .	24	Shielding, Methods of . . . . .	8
General . . . . .	24		
Single headset receiver . . . . .	24		

	Page		Page
Short (transmission path terminated in a short) . . . . .	38	Thermistors . . . . .	31
Movable short . . . . .	38	Directly heated thermistor . . . . .	31
Signals . . . . .	27	Indirectly heated thermistor . . . . .	31
Sounder . . . . .	27	Thermocouples . . . . .	31
Chime, tone bar, etc, type sounder . . . . .	27	Directly heated thermocouple . . . . .	31
Telegraph-type sounder . . . . .	27	Indirectly heated thermocouple . . . . .	31
Switch (Any number of transmission paths may be used - coaxial and waveguide symbol) . . . . .	39	Timer . . . . .	31
Switches . . . . .	28	Tone Alternator . . . . .	31
Cover- or door-type switches . . . . .	29	Transformation for tapers and step trans- formers without mode change . . . . .	39
Crossbar selector-type switch . . . . .	29	Application: Transformer with mode suppression . . . . .	39
Knife, rotary, snap, toggle, or tumbler-type switches . . . . .	29	Transformer . . . . .	2,11,12,32
Rotary-type (high voltage) . . . . .	30	Transistor . . . . .	2,32
Selector-type switches . . . . .	30	(semiconductor devices) . . . . .	2,32
Sequence-type switches . . . . .	28	(semiconductor devices) components . . . . .	2,32
Step-by-step system selector-type switches.	28	Transmission Path . . . . .	34
Switchhook . . . . .	30	Transmitters . . . . .	33
Symbol Components . . . . .	2	Tube, Electron . . . . .	3,33
Attached-contact schematic . . . . .	2	Cathode-ray tube . . . . .	33
Coaxial and waveguide . . . . .	34	Cold cathode tube . . . . .	33
Complete apparatus . . . . .	9	Pentode tube . . . . .	34
Detached-contact schematic . . . . .	6	Twin-triode tubes . . . . .	34
Line . . . . .	7	Tube, showing shield sleeve . . . . .	6,34
Terminals . . . . .	30	Variable, when used with normal symbol for capacitor, etc . . . . .	6
Apparatus terminal . . . . .	30	Varistors or Metallic Rectifiers . . . . .	34
Coaxial terminal . . . . .	30	Vibrator . . . . .	34
Cross-connecting terminal . . . . .	30	Typical separate drive . . . . .	34
Terminal strip or terminal punching . . . . .	30	Typical shunt drive . . . . .	34
Terminal Strip . . . . .	30	Waveguide Symbols . . . . .	34
Test Point . . . . .	30	Windings . . . . .	6
Thermal Devices . . . . .	30	Inductive winding for relays, electromagnets, etc . . . . .	6
External heater unit . . . . .	26,30	Inner end of windings of relays, electromagnets, etc . . . . .	6
Integral heater unit . . . . .	31	Noninductive winding . . . . .	6
Self-heated unit . . . . .	26,31		
Thermal Element . . . . .	2		