

GENERAL DESCRIPTION

No. 5 CROSSBAR SYSTEM

CONTENTS	PAGE	CONTENTS	PAGE
1. INTRODUCTION .....	3	Manual Calls .....	20
2. SWITCHING PRINCIPLES .....	4	Dialing Into An Adjacent Area ....	20
A. General .....	4	Various Call Conditions .....	21
B. Major Switching Frames .....	5	C. Message Charging On Coin and Noncoin Calls .....	22
General .....	5	Prepayment Coin Service .....	22
Line Link Frames .....	5	Message Register Service .....	23
Junctors .....	6	AMA Service .....	24
Trunk Link Frames .....	7	D. Operation of No. 5 Crossbar Office With Combined Toll and DSA Switchboard .....	24
Channels .....	8	E. Operation of No. 5 Crossbar Office With DSB Switchboard .....	26
3. EQUIPMENT ELEMENTS .....	8	F. No. 5 Crossbar Office With Tandem Switching Features .....	27
A. General .....	8	G. No. 5 Crossbar Office With Toll Center Switching Features .....	28
B. Line Link Frames .....	8	H. Multioffice Operation .....	29
C. Trunk Link Frames .....	8	I. Physical-Theoretical Office Operation .....	29
D. Extension Trunk Link Frames .....	9	J. Intermarker Group Operation .....	30
E. Junctor Grouping Frame .....	9	K. Direct and Alternate Route Arrangements in the No. 5 Cross- bar System .....	32
F. Markers .....	9	L. Operator Junctor Operation .....	32
G. Originating Registers .....	10	M. Coin Junctor Operation .....	33
H. Pretranslators .....	10	N. AMA Junctor Operation .....	33
I. Number Groups .....	10	O. Selection Preference .....	33
J. Outgoing Senders .....	10	P. Code Conversion .....	34
K. Outgoing Sender Links .....	11	Q. Calls Involving Equipment Irregularities .....	34
L. Incoming Registers .....	11	5. EQUIPMENT ARRANGEMENTS .....	35
M. Incoming Register Links .....	11	6. MAINTENANCE FEATURES .....	35
N. Intermarker Group Senders .....	11	A. General .....	35
O. Connectors .....	11	B. Test Set-type Testing Arrangements for Registers and Senders .....	37
P. Trunks .....	12	C. Electronic Pulse Generator .....	38
Q. Coin Supervisory Circuits .....	13	D. Testing Equipment for Subscriber Message Registers .....	38
R. Coin Supervisory Links .....	13	E. Arrangement for Testing Sub- scriber Station Ringers .....	38
S. Message Register Frames .....	13	F. Central Office Alarm System .....	38
T. Foreign Area Translators .....	13	G. Automatic Line Insulation Test Equipment .....	38
4. METHOD OF OPERATION .....	13	7. GLOSSARY .....	38
A. General .....	13		
B. Noncoin Calls Excluding Message Charging .....	15		
Dial Tone Connection .....	15		
Establishing Dialing Connection ..	15		
Pretranslation .....	16		
Intraoffice Calls .....	16		
Interoffice Calls - Outgoing .....	18		
Interoffice Calls - Incoming .....	18		
Reverting Calls .....	19		
Assistance and Service Code Calls	20		

FIGURES

- 1 - Partial Perspective View of 20-vertical Unit Crossbar Switch (200 Point)
- 2 - Equipment Schematic of a No. 5 Crossbar Office
- \*3 - Line Link Frame
- 4 - Line Link Distribution
- 5 - Junctor Distribution (4 Line Links and 2 Trunk Link Frames)
- 6 - Pairing of Trunk Link Frames (40 Line Links and 20 Trunk Link Frames)
- \*7 - Trunk Link Frame
- 8 - Trunk Link Distribution
- 9 - Switch Arranged for 16 Trunk Appearances on Trunk Link Frame
- 10A- Channels for 20 Line Links - 10 Trunk Link Frames
- 10B- Channels for 10 Line Links - 5 Trunk Link Frames
- 11 - Line Link Frame and Supplementary Line Switch Bay
- 12 - Trunk Link and Trunk Link Connector Frame
- 13 - Junctor Grouping Frame
- 14 - Marker Frame - Common Equipment Frame
- 15 - Marker Frame - Translator and Route Relay Frame
- 16 - Marker Frame - Trunk Frame Test Lead Connector Bay
- 17 - Marker Frame - Class-of-Service Bay
- 18 - Tandem Code Screening and Code Conversion Frame
- 19 - PBX Allotter Frame
- 20 - Originating Register Frame
- 21 - Pretranslator and Pretranslator Connector Frame
- 22 - Number Group Frame
- 23 - Outgoing Sender Frame
- 24 - Register and Sender Link Frames
- 25 - Tandem Revertive Pulse Incoming Register Frame

\*Indicates inserted figure.

FIGURES

- 26 - Marker Connector Frames
- 27 - Connector Frames
- 28 - Foreign Area Translator Connector Frame
- 29 - Trunk Relay Rack
- 30 - Message Register Frames
- 31 - Foreign Area Translator Frame
- \*32 - Dialing Connection
- \*33 - Intraoffice Trunk Connection
- \*34 - Reverting Trunk Connection
- \*35 - Outgoing Trunk Connection
- \*36 - Incoming Trunk Connection
- 37 - Establishing Dialing Connection
- 38 - Line Link Frame Schematic (Wiring Side) - Frame Arranged for 490 Lines
- 39 - Establishing Intraoffice Trunk Connection
- 40 - Establishing Outgoing Trunk Connection
- 41 - Establishing Incoming Trunk Connection
- 42 - Establishing Reverting Trunk Connection
- 43 - Establishing Toll and DSA Operator, Service Code, or Manual Trunk Connection
- \*44 - Association of Coin Trunk and Coin Supervisory Link
- \*45 - Intervals for Coin Operation With Overtime
- \*46 - Traffic at Toll and DSA Switchboard Associated With a No. 5 Crossbar Office
- 47 - Call From a Toll and DSA Switchboard Completed to No. 5 Crossbar Subscriber
- 48 - Outgoing Call From Toll and DSA Switchboard (Pulse Conversion)
- 49 - Operation of No. 5 Crossbar Office Associated With DSB Switchboard
- 50 - Tandem Center Switching Combined With Local Completion to Subscribers in the Same Marker Group
- 51 - Toll Center Switching Combined With Local Completion to Subscribers in the Same Marker Group

FIGURES

- 52 - Intermarker Group Trunk Connection - Subscriber to Subscriber
- 53 - Intermarker Group Trunk Connection - Subscriber to Trunk
- 54 - Intermarker Group Trunk Connection - Trunk to Subscriber
- 55 - Call From a Toll and DSA Switchboard Associated With a No. 5 Crossbar Office to a Connecting Office
- 56 - Coin Junctor Operation
- 57 - Floor Plan
- 58 - Master Test Frame - Recorder, Control, and Jack Bays
- 59 - Master Test Frame - Automatic Monitor, Register, and Sender Test Bays
- 60 - Master Test Connector Frame
- 61 - Trouble Recorder Cards
- 62 - Line Insulation Test Frame

1. INTRODUCTION

1.01 This section describes in general terms the No. 5 crossbar dial telephone switching system. It replaces Section A874.001.1 and describes additional features. One of the principal features of the design is that this system can interconnect with many different types of equipment. This makes it attractive for areas on the outskirts of large cities where it is necessary to complete calls to the metropolitan offices as well as to varieties of outlying suburban offices. The flexibility of the new system is such that it can often be used economically in comparatively small offices, as well as in larger offices of such networks. It can be introduced in any area without major changes in existing step-by-step, panel, or No. 1 crossbar offices and without changes in existing dial telephone instruments. This system can interconnect directly with all present local, tandem, and toll offices, except that it cannot direct traffic to distant office tandem (panel 2-wire office selectors).

1.02 The following are some of the highlights of this system:

(a) Common Control: The control of switching the traffic in an office is concentrated in certain equipment units which are common to all frames. An advantage of

common control operation is that only a few circuits need be provided to set up the connection, and these can be equipped with self-checking and service safeguarding features, the cost of which would be prohibitive if many circuits were involved.

(b) Methods of Charging: Automatic message accounting (AMA) is especially well suited for operation with the No. 5 crossbar system. This method takes a permanent record of charge data on paper tape and requires very little manual operation. (For a complete description, see X-63915, No. 5 Crossbar System - AMA Features.) Message register and coin service can also be provided by the No. 5 system; however, there is no zone registration or coin zone dialing.

(c) Maintenance: This system is more self-checking than other present systems. The marker (a unit of common control equipment) has access to most of the elements in an office, and it is able to gather information from many sources on the performance of the different parts. It can, therefore, automatically refer to the maintenance force information regarding trouble conditions. When a trouble is encountered, a trouble recorder makes a permanent record on punched cards which can be used by the maintenance force as an aid in locating the trouble. The majority of the testing equipment is mounted on several bays which collectively are called the master test frame.

1.03 This system can handle the dialing of directory numbers consisting of from four to eight digits. It also can handle up to eleven digits for any extension of subscriber and operator dialing outside of the home numbering plan area. Thirty classes of service are provided, including coin and non-coin, flat rate and message rate, individual and party lines (see Glossary).

1.04 Tandem and toll center switching features can be provided in a No. 5 crossbar office. Such an office acts as a toll and tandem traffic center as well as a local office.

1.05 This system can operate with present dial systems with their particular types of pulsing: dial, revertive, or multifrequency. However, because multifrequency pulsing is generally more efficient than other types of pulsing, it is used by the No. 5 office whenever practicable. Table A shows the usual kinds of pulsing or manner of operation for the various combinations of No. 5 crossbar and connecting offices. When more than one type of pulsing is available, the preferred type is shown first.

Table A

Type of Pulsing Received From No. 5 Crossbar Office	Type of Office	Type of Pulsing Sent to No. 5 Crossbar Office
Multifrequency (MF) Dial (DP) Revertive (RP)	No. 5 Crossbar	Multifrequency (MF) Dial (DP) Revertive (RP)
Multifrequency (MF) Revertive (RP) Dial (DP)	No. 1 Crossbar	Revertive (RP)
Revertive (RP)  Dial (DP)	Panel  Step-by-Step	Revertive (RP)  Dial (DP)
Panel Call Indicator (PCI) Straightforward (Nonpulsing) Step-by-Step Call Indicator (DP)	Manual	Multifrequency (MF) Dial (DP) Straightforward (Via DSB Switchboard)
Panel Call Indicator (PCI)	Panel Sender Tandem	Revertive (RP) Dial (DP)
Multifrequency (MF) Dial (DP)	Crossbar Tandem	Multifrequency (MF) Dial (DP) Revertive (RP)
Multifrequency (MF) Dial (DP)	No. 4-type Toll (Crossbar)	Multifrequency (MF) Dial (DP) Revertive (RP)
No Provision	Panel Distant Office Tandem (2-way Office)	Revertive (RP)

## 2. SWITCHING PRINCIPLES

### A. General

2.01 This part describes the means which the No. 5 crossbar system uses to give its customers telephone service. The switching principles are explained in terms of the switching frames. Before these switching principles are discussed, however, a short description is given of the operation of the crossbar switch which is fundamental to the understanding of this system.

2.02 The basic element in any crossbar system is the crossbar switch which also gives the system its name. Talking connections through switching frames are made by crossbar switches.

2.03 The crossbar switch is essentially a relay mechanism consisting of ten horizontal paths and ten or twenty vertical paths, depending on what size switch is needed. Any horizontal path can be connected to any vertical path by means of magnets. The points of connection are known as crosspoints. The switch with ten vertical paths has 100 crosspoints and is called a 100-point switch; the one with twenty vertical paths has 200 crosspoints and is called a 200-point switch. Fig. 1, attached, shows a partial perspective view of a crossbar switch.

2.04 Horizontal Paths: There are five selecting bars mounted horizontally across the face of each switch. Each selecting bar has flexible selecting fingers attached to it, one finger for each vertical path, and the bars can be rotated slightly to cause the select fingers to go either up or down under control of select magnets. This forms two horizontal paths per bar, making a total of ten horizontal paths.

2.05 Vertical Paths: Ten or twenty vertical units are mounted on the switch and each unit forms one vertical path. Each unit operates under control of a hold magnet and has ten groups of contacts (one for each horizontal path) associated with it.

2.06 Each group of contacts may consist of three to six pairs of contact springs. A switch is classified according to the number of crosspoints and pairs of springs; for example, a 200-point, 3-wire crossbar switch.

2.07 Operation of the Crossbar Switch: The normal position of the selecting fingers is horizontal, lying between two groups of contacts. When a select magnet operates, the selecting bar is rotated and one of the horizontal paths available to this bar is chosen. The selecting fingers now lie in front of a group of contacts.

2.08 The hold magnet of the vertical path to be connected to this horizontal path then operates its holding bar which, using the selecting finger as a wedge, causes the group of contacts beside the selecting finger to operate, thus connecting the horizontal and vertical paths. Both the select and hold magnets must be operated in order to close a crosspoint. The other groups of contacts on this vertical unit do not operate since there is no selecting finger between them and the holding bar.

2.09 After the operation of the hold magnet, the select magnet releases, returning the horizontal bar and all but one of the selecting fingers back to normal. The finger used to establish the connection, being flexible, remains wedged against the contacts by the holding bar and in this way keeps the contacts operated. When the hold magnet releases, the connection is released and the selecting finger returns to normal.

#### B. Major Switching Frames

##### General

2.10 All connections in the talking path to No. 5 crossbar subscribers are established

through two kinds of switching frames; line link frames and trunk link frames. The subscriber lines are connected to the switches on the line link frames, and the various trunks and register circuits are connected to the switches on the trunk link frames. These frames interconnect over junctors that are attached to junctor switches which appear on the line link and trunk link frames. These switching operations are controlled by control equipment which includes markers and associated connectors.

2.11 Fig. 2, attached, is a simple diagram showing the relationship of the switching frames and the common control equipment.

#### Line Link Frames

##### General

2.12 The crossbar switches on the line link frame are divided functionally into line switches and junctor switches. Subscriber lines are connected to the line switches and junctors to the junctor switches. Line links, which are merely connecting wires, are provided for interconnecting the line switches and

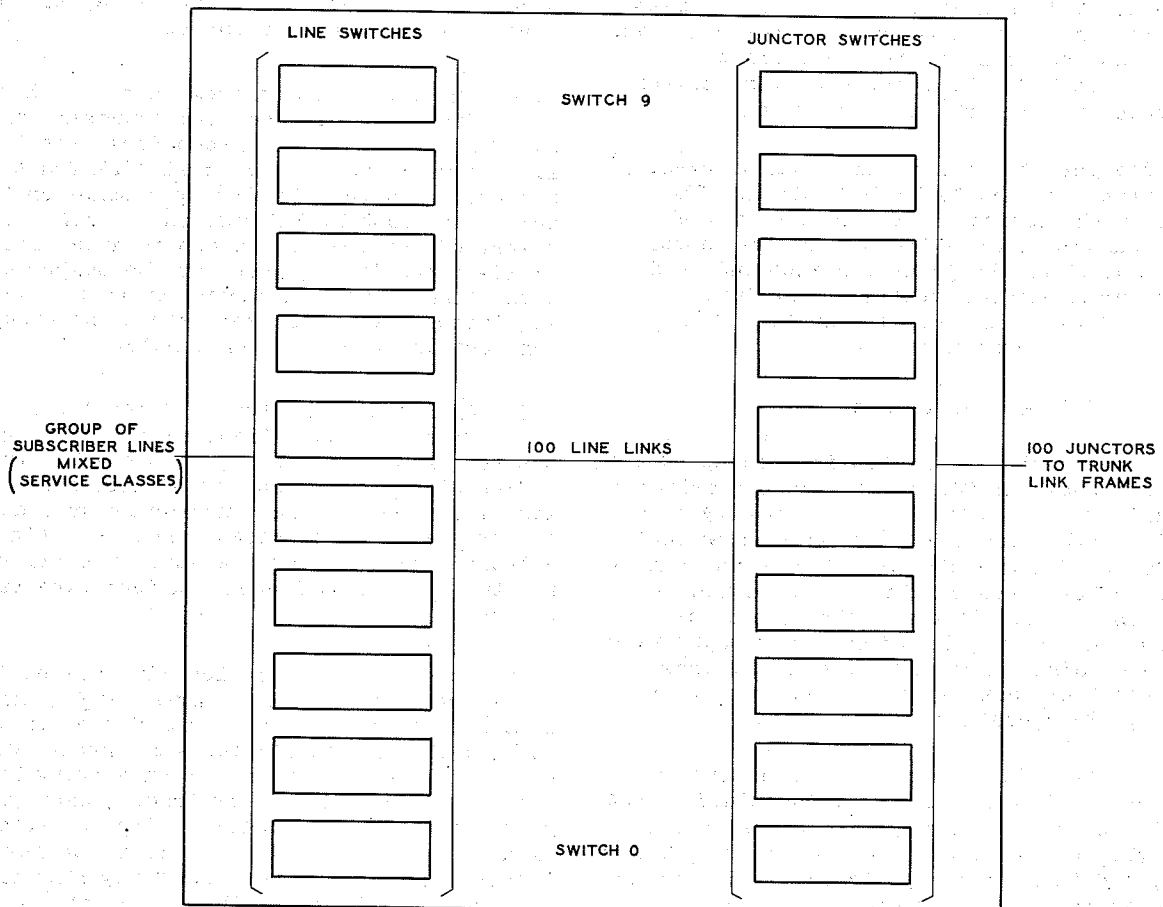

Fig. 3 - Line Link Frame

junction switches; hence the name line link frame. Fig. 3 is a simple diagram of a line link frame.

#### Line Switches

2.13 The basic line link frame is a 2-bay framework with each bay mounting ten 200-point crossbar switches. One and one-half switches on each level are used as line switches. Each vertical on a line switch is used for a subscriber line except one which is used for no-test access to the remaining 29. One advantage of using a vertical for a subscriber's line is that the off-normal springs of the hold magnet can be used as a cutoff relay. The half switches not used as line switches are used as junction switches thus providing ten verticals for terminating the junctions on each level. The line relays, one for each subscriber line, are mounted at the top of the line link frame.

2.14 Line links appear on the horizontals of the switches; ten line links on each switch. These ten line links are distributed among the ten junction switches, one line link to one horizontal on each of the ten junction switches. This system of line links permits each line on a line link frame to reach any one of the 100 junctions serving that frame. Fig. 4, attached, shows how each line switch has access to all the junction switches.

2.15 Any particular line link can be readily traced by the following method. The number of the horizontal on the line switch end of the line link is the same as the number of the switch on the junction switch end, and the number of the horizontal on the junction switch end is the same as the number of the switch on the line switch end.

#### Capacity of Line Link Frames

2.16 Since each line switch is made up of one and one-half 200-point crossbar switches, the basic line link frame has a capacity of 300 line switch verticals (30 on each switch) and 100 line links. However, the actual number of subscriber lines on this frame is 290 because ten line switch verticals (one on each line switch) are required for no-test operation, such as obtaining access to busy lines from the local test desk and verification of busy lines by DSA operators.

2.17 Greater line capacity than is provided by the basic frame can be obtained by the addition of supplementary bays of switches. The number of lines which can be served by 100 links, and therefore by a frame, is determined by the average incoming plus outgoing usage (calling rate times holding time) of the lines. To take care of varying requirements,

provision is made for adding supplementary bays to serve from 290 to 590 lines in steps of 100 lines. The size of the frame does not affect the following description of its functions.

2.18 A feature of this line link frame is that the same frame can serve customers who have various classes of service; for example, coin, flat-rate, and message-rate customers can have their lines all terminating on the same frame. A maximum of thirty classes of service can be served on a frame and this is also the maximum that can be served by one marker group.

#### Junctions

2.19 Each line link frame has 100 junction terminations which are used to connect to all the trunk link frames in the office. Since each trunk link frame has 200 junction terminations for connecting to all line link frames, the ratio of line link frames to trunk link frames in an office generally is 2:1. There are no half frames. (In an office with thirteen line link frames, there are usually seven trunk link frames.) However, conditions peculiar to a particular office may cause some variation in this ratio.

2.20 The 100 junctions from each line link frame are divided into approximately equal groups, with one group from each line link frame going to each trunk link frame. The number of junctions in a group depends on the number of trunk link frames in the office. The number of junctions per group is determined by dividing the 100 junctions by the number of trunk link frames. However, there is a limiting factor; for efficient service no group can contain less than ten junctions.

2.21 When there are ten or fewer trunk link frames in an office, each junction group has ten or more junctions; for example, in an office with eight trunk link frames and sixteen line link frames, each junction group contains either twelve or thirteen junctions. Fig. 5, attached, illustrates the junction distribution for two trunk link frames and four line link frames.

2.22 However, in an office with eleven to twenty trunk link frames, each junction is multiplied to two trunk link frames in order to have at least ten junctions per group; for example, in an office with twenty trunk link frames and forty line link frames, each junction group contains ten junctions. Fig. 6, attached, illustrates the junction distribution for twenty trunk link frames and forty line link frames. In this case, the number of junctions in a group is determined by dividing 100 by the number of pairs of trunk link frames.

Trunk Link Frames

## General

2.23 The trunk link frame is made up of trunk switches, junctor switches, and various miscellaneous circuits. Trunks and originating registers (which register the called number) are connected to the trunk switches. The junctors from the line link frame are connected to the junctor switches. The trunk and junctor switches are interconnected by trunk links which are similar to line links. The trunk links go from the junctor switch verticals to the trunk switch verticals; line links are connected horizontal-to-horizontal. A diagram of a trunk link frame is shown in Fig. 7.

## Trunk Links and Junctors

2.24 The system of trunk links that permits any outlet or trunk on a trunk link frame to be connected to any one of the 200 junctors serving that frame is similar in principle

to that used on line link frames. The number of trunk links, which is 200, is the same as the number of junctors. The trunk links run from vertical to vertical, the junctors being connected to the horizontals of the junctor switches and the trunks to the horizontals of the trunk switches. In order to terminate twenty junctors on the horizontals of one 200-point switch, it is necessary to split the horizontal multiple into a left-hand and a right-hand half-switch. The two half-switches thus formed are treated separately and the numbering of the verticals in each half is similar, but they are identified as left and right. Although the trunk switches are not physically split, the numbering of verticals is also on a left and right basis.

2.25 The trunk link distribution is similar to that provided for the line link distribution. The vertical number at one end of a link is always the same as the switch number at the other end of the link. In addition, a vertical on the left half of a switch is always

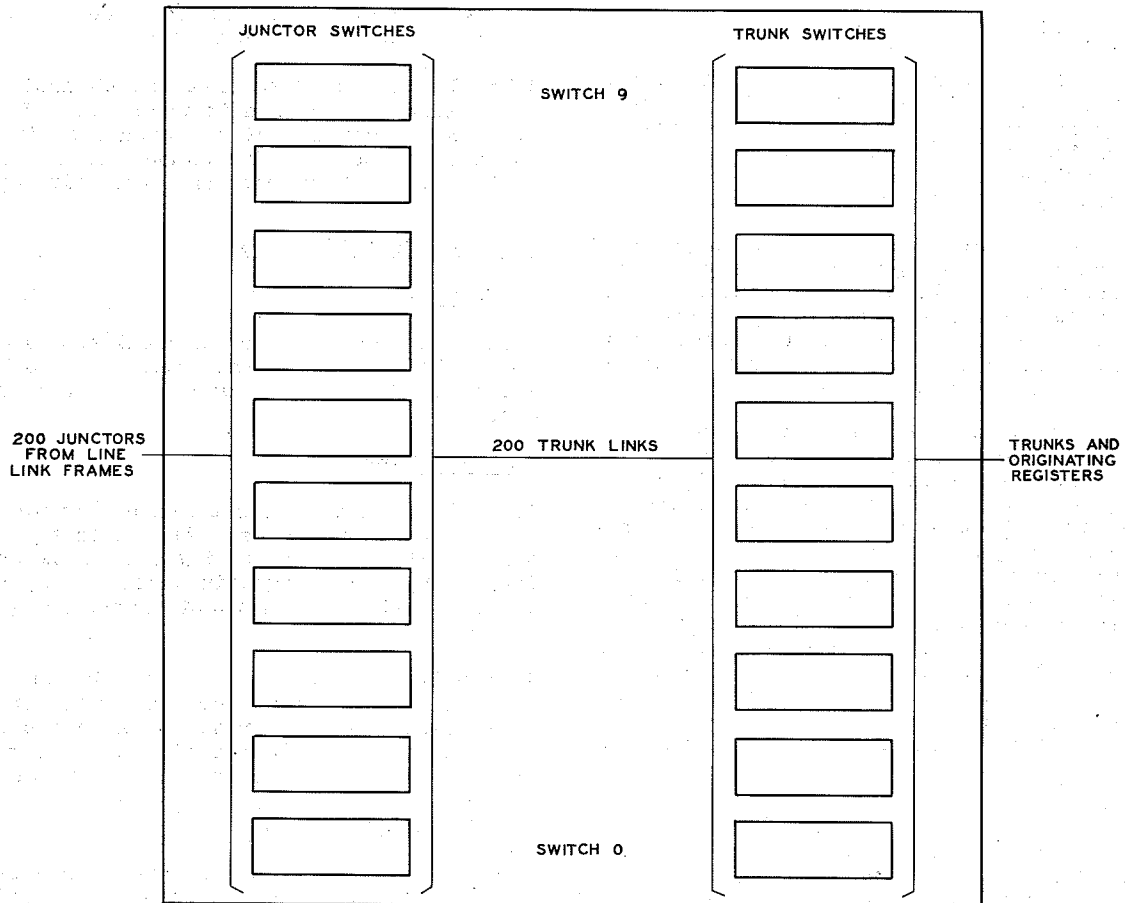

Fig. 7 - Trunk Link Frame

connected to a vertical on the left half of the switch at the other end of the link, and a vertical on the right half of a switch is always connected to a vertical on the right half of the switch at the other end of the link. (See Fig. 8, attached.)

#### Extension Trunk Link Frame

2.26 As stated previously, when eleven to twenty trunk link frames are involved, each junctor is multiplied to two trunk link frames in order that each junctor group contain a minimum of ten juncctors. This requirement reduces the junctor capacity of the basic trunk link frames by 50 per cent, and it is necessary to provide additional junctor switches for each trunk link frame. These additional switches are mounted on the extension trunk link frame which, if equipped initially, is placed adjacent to the junctor switch bay of the trunk link frame. The extension frame consists of a framework with ten 200-point, 3-wire switches the same as the junctor switches on the trunk link frame. These switches have a capacity for 200 juncctors which, with the 200 juncctors on the trunk link frame, provide a total of 400 juncctors for the combination.

#### Trunk Switches

2.27 The ten trunk switches on the trunk link frame are 6-wire switches. They furnish locations for 160 trunks. Each switch has locations for sixteen trunks on eight of its levels (horizontal). Fig. 9, attached, illustrates how this is accomplished.

2.28 The 6-wire switches are so arranged that each one of levels 2 to 9 terminates on two 3-wire trunks. One trunk on each level is connected to one set of three wires of the horizontal multiple and designated appearance A, and the other trunk to a second set of three wires and designated appearance B.

2.29 The trunk link is wired to the first three nonmultiple terminals of level 1 and the last three nonmultiple terminals of level 0. Each operation of the trunk switch requires two select magnet operations. Either 0 or 1 select magnet must be operated to direct the trunk link to the proper 3-wire connection of the vertical, and in addition, the select magnet associated with one of the levels 2 to 9 where the trunk appears must be operated. The levels 0 and 1 are directing levels. The eight appearances on each switch that are selected by horizontal 0 are called A appearances and those selected by horizontal 1 are called B appearances.

#### Channels

2.30 A channel is a combination of a line link, a junctor, and a trunk link that can be formed, by crosspoint closures, into a chain that interconnects a line and a trunk. Each line link, junctor, and trunk link consists of a tip, ring, and sleeve lead with a switch appearance at each end.

2.31 The ten or more juncctors in a group connecting a line link frame with a trunk link frame are distributed over the ten junctor switches of both the line link and trunk link frames, the junctor switch number being the same on both ends for each junctor. There are ten line links serving each particular subscriber line on the line link frame, and these are also distributed over the ten junctor switches.

2.32 There are twenty trunk links serving each particular trunk on the trunk link frame, and these are also distributed over the ten junctor switches. Thus, when a particular line and a particular trunk for a unit consisting of, for example, twenty line link and ten trunk link frames are considered, there are ten channels available for a connection. These channels are numbered according to the junctor switches on which they terminate, as illustrated in Fig. 10A, attached. An idle channel is selected by testing the ten channels at the same time. For job sizes other than the above, there are more than ten channels available. For example, in a 10-line link and 5-trunk link frame job, there are twenty channels provided, as illustrated in Fig. 10B, attached. In these cases, additional tests are made when an idle channel is not found in the first ten channels tested.

2.33 It will be seen that the channel number also corresponds to the number of the line switch horizontal on which the line link appears, as well as the number of the trunk switch vertical on which the trunk link appears.

### 3. EQUIPMENT ELEMENTS

#### A. General

3.01 The functions and physical appearance of the main equipment elements in a No. 5 crossbar office are briefly described in this part.

#### B. Line Link Frames

3.02 Line link frames contain subscriber line appearances. All calls to or from a subscriber go through the line link frame. These frames also contain access leads for tandem, toll, and intercept trunks and test lines.

3.03 Fig. 11, attached, shows the basic 2-bay line link frame for 290 lines with combined line and junctor switches in one bay and line switches in the other. It also shows the 100-line supplementary line switch bay.

#### C. Trunk Link Frames

3.04 Trunk link frames are 2-bay frames which contain the access leads for originating registers and trunks. Fig. 12, attached, shows this frame associated with an initial trunk link connector frame which is always located next to it.



D. Extension Trunk Link Frames

3.05 Extension trunk link frames are one-bay junctor switch frames and correspond to the junctor switch bay shown in Fig. 12, attached. When extension frames are required, there is one for each trunk link frame.

E. Junctor Grouping Frame

3.06 Fig. 13, attached, shows the junctor grouping frame. It is a single-sided, 1-bay frame consisting primarily of terminal strips, fanning rings, and rings for jumpers. The junctor grouping frame provides means for terminating the junctor ends which originate at the line link frames and trunk link frames, and for cross-connecting these terminations so that equal access to all trunk link frames is obtained by all line link frames.

F. Markers

3.07 The marker is the most active piece of common control equipment in the office. It is used one or more times in the completion of every call. Different offices have various numbers of markers depending on the size of the office and the amount of traffic. All the markers and their associated equipment serving up to a maximum of 20,000 numbers make up a marker group.

3.08 There are three types of markers: (1) combined, (2) dial tone, and (3) completing. The combined marker performs all the marker jobs listed below; the dial tone and completing markers divide the jobs of the combined marker between them. The dial tone marker is used exclusively on dial tone jobs and the completing marker performs all the other jobs. Economic and traffic conditions determine whether an office has a single group of combined markers or a subgroup of dial tone and a subgroup of completing markers.

3.09 The dial tone and completing markers are independent of each other; individual office requirements determine how many markers of each type are required.

3.10 The principal functions of the marker, whether combined or split, are:

(a) To respond to demands for dial tone by determining the location of the calling line on the line link frame and establishing a connection from the calling line to an originating register. It passes the calling line location and subscriber class-of-service information to the originating register. The register stores this information, and after dialing is completed, passes it back to a combined or completing marker to establish the connection.

(b) To determine the proper route for the call from the office code digits of the called number and the class of service of the calling subscriber.

(c) To establish the connection from a calling subscriber to a trunk or from a trunk to a called subscriber.

(d) To connect to the proper number group to learn the location of the called line on the line link frame.

(e) To determine from the class of service and the destination the proper charge condition for the call.

(f) When outgoing pulsing is required, to select an outgoing sender of the proper type. The marker then passes information to the sender which the sender transmits when the connecting office equipment is ready.

(g) To recognize line busy, vacant numbers, and intercept conditions, and to control hunting operation in terminal hunting groups.

(h) To complete a call under certain trouble conditions.

(i) To call in the trouble recorder which makes a record of the marker progress if its operation is abnormally delayed or if there are certain trouble conditions.

Special Features in the Marker

3.11 Two markers (0 and 1) in a group of combined or completing markers are usually equipped with special features for handling certain test calls. These calls are set up by operators, testmen, or maintenance men and are of the following types:

- (a) No-test calls originated at the test desk or a DSA switchboard.
- (b) No-hunt calls originated at the outgoing trunk test frame or the message register rack.
- (c) Special hunt test calls originated at the local test desk.

The regular subscriber line tests (ground and continuity) which are performed by the marker during normal operation are cancelled on all these calls.

3.12 The marker normally completes each of its various functions in less than one second. Therefore, a small number of markers can serve a large office.

3.13 Each combined or completing marker is made up of the following frames:

Common equipment frame designated COM EQPT. (See Fig. 14, attached.)

Translator and route relay frame designated T & RR. (See Fig. 15, attached.)

Trunk frame test lead connector bay designated TFTLC, serves six markers. (See Fig. 16, attached.)

Class-of-service bay designated CLS, serves four markers. (See Fig. 17, attached.)

3.14 Some of the features available in the No. 5 crossbar system require that an equipment frame be added to the combined or completing markers when the feature is used. These frames are the following:

- (a) Tandem code screening frame designated TCS. (See Fig. 18, attached.) The frame serves 5, 6, 7, or 8 markers depending upon the number of office code for which screening provision is desired. The feature is described under F, Method of Operation.
- (b) PBX allotter frame. (See Fig. 19, attached.) A basic frame designated PBX ALLR serves eight markers and four PBX. A supplementary frame designated SPBX ALLR serves eight markers and six PBX. The feature is described under B (Intraoffice Call - Terminal Hunting), Method of Operation.
- (c) Code conversion and route relay frame designated CC&RR. (See Fig. 18, attached.) A frame serves one combined or completing marker. It is required when 2-digit or 3-digit arbitrary codes are to be outpulsed from a No. 5 office. The feature is described under P, Method of Operation.

3.15 Each dial tone marker is made up of a common equipment frame.

3.16 The marker frames are cross-connected through terminal strips. This method of assigning marker cross connections simplifies making changes and insures flexibility of connections.

#### G. Originating Registers

3.17 Originating registers furnish dial tone to subscribers and record the digits that are dialed. After dialing is completed, the called number is transmitted from the register to a marker. These registers also make party test to determine whether a tip or ring party is making the call. Originating registers appear on trunk link frames and one is connected to the subscriber's line by the combined or dial tone marker when the customer lifts the receiver off the hook.

3.18 A No. 5 crossbar office which includes any coin lines must have all the originating registers in the office arranged for coin operation.

3.19 There are five registers on each originating register frame. This 2-bay frame is designated OR. (See Fig. 20, attached.)

#### H. Pretranslators

3.20 Pretranslator circuits may be provided in offices located in areas where some calls require the dialing of more digits than others. The originating register circuit may be arranged to seize the pretranslator after

either the second or third digit has been dialed. From these digits, the pretranslator determines how many more digits the register should expect before seizing a marker.

3.21 The pretranslator frame is a single-bay frame with space for two pretranslators and two pretranslator connectors. (See Fig. 21, attached.) If another pretranslator is necessary, a second frame is provided for one pretranslator and its connector. Two pretranslators are adequate for most marker groups. The arrangements provide for one pretranslator group to serve two marker groups when desired.

#### I. Number Groups

3.22 The number group translates subscriber directory numbers into line equipment locations of subscriber lines. (The line equipment location identifies the line link frame location of a subscriber line.) The number group also supplies the proper ringing control information and other information concerning the called number, such as whether it is in a terminal hunting group or in a physical or theoretical office.

3.23 A number group frame serves 1000 consecutive directory numbers. (See Fig. 22, attached.) For example, number group frame 1 contains directory numbers whose numericals are 1000 to 1999. Therefore, the total amount of directory numbers, in multiples of 1000, to be equipped, determines how many number group frames are required. A maximum of twenty number group frames, exclusive of trunk number frames, can be associated with one marker group.

#### J. Outgoing Senders

3.24 An outgoing sender is employed on all calls requiring pulsing to connecting offices. The marker transfers the required digits of the called number to a sender which is connected to an outgoing trunk. The function of the sender is to furnish the pulses which control the operation of the switching equipment in the connecting office. The type of connecting office (step-by-step, panel, manual, or crossbar) determines what kind of sender should be used to transmit the called number. Therefore, four different types of outgoing senders are provided in a No. 5 crossbar office, as listed below:

Dial pulse (DP)

Multifrequency (MF)

Revertive pulse (RP)

Panel call indicator (PCI)

3.25 The outgoing sender frame mounts as many as five senders which may be of one type or any combination of the four types. (See Fig. 23, attached.)

3.26 The multifrequency outgoing sender requires an ac supply of six different frequencies. These are used in various combinations of two each for the digits 0 to 9 and the start and end signals.

#### K. Outgoing Sender Links

3.27 Outgoing sender links connect outgoing and intermarker group senders to outgoing trunks. Information from a sender to a trunk is transmitted through this sender link.

3.28 One sender link frame (designated OSL) mounts ten 200-point crossbar switches. (See Fig. 24, attached.) The four types of outgoing senders, MF, DP, RP, PCI, and intermarker group senders may be located on one sender link frame.

#### L. Incoming Registers

3.29 Incoming registers record the pulses on calls received over incoming trunks from operators or connecting offices. Since these pulses are incoming from various types of offices, the following different incoming registers are provided to record them:

- (a) Dial pulse (DP).
- (b) Multifrequency (MF).
- (c) Revertive pulse (RP). There are three types of revertive incoming registers:
  - (1) The local revertive incoming register receives the four numerals from the originating panel or crossbar office. This register can recognize the "High Five" incoming group indication in selecting one of two terminating offices.
  - (2) The central B incoming register receives its digits from a central B operator's position sender on a revertive basis. The B operator receives the number from the manual A operator or toll operator on a straightforward basis.
  - (3) The tandem revertive pulse incoming register receives from the originating panel or crossbar equipment, office brush and office group selections in addition to the four numerals. The office brush and group selections are translated into an office code from which the marker determines the routing of the call.

3.30 With the exception of the revertive tandem type, these registers are all mounted on the same type of frame (designated IR) as the originating registers (see Fig. 20). The registers on one frame may be all of one type or any combination of the first four types. The revertive tandem registers are mounted two per bay including a cross-

connecting field and cannot be mixed with any other type. (See Fig. 25, attached.)

3.31 Each MF incoming register has a MF receiving unit associated with it. These units receive and amplify the MF pulses and convert them into dc pulses which operate the register relays in the associated MF incoming register. These units are mounted on miscellaneous relay racks.

#### M. Incoming Register Links

3.32 The incoming register links connect incoming trunks to incoming registers. Information from incoming trunks to incoming registers is transmitted through these links.

3.33 One link frame (designated IRL, see Fig. 24) has five 200-point crossbar switches and gives 100 trunks access to a maximum of ten incoming registers. The capacity of the frame can be expanded to as many as 600 trunks by adding supplementary, auxiliary, and auxiliary supplementary frames. A separate incoming register link frame is required for each type of incoming register.

#### N. Intermarker Group Senders

3.34 The intermarker group sender is used for traffic between two different No. 5 crossbar marker groups housed in the same building. It serves in two capacities: as an outgoing sender for the calling marker and as an incoming register for the called marker.

3.35 Six senders can be mounted on the single-bay frame which is designated IMGS.

#### O. Connectors

3.36 A connector is a relay-type switching device for interconnecting, for a short interval of time, two equipment elements by a relatively large number of leads.

3.37 A specific method is used in naming these connectors. If more than one type of equipment can originate action toward another type, the connector is named according to both the originating and terminating action; for example, in connectors such as the line link marker connector with the word "marker" in the title, the action terminates in the marker and is originated by the line link frame. The originating circuit must be mentioned because many circuits can originate action toward the marker.

3.38 Similarly, when only one type of equipment can originate action toward another type, the connector is named according to where the connector action terminates. For this reason the connectors from markers to other frames do not contain the word "marker" in the title.

3.39 This method of naming is illustrated in the following list of principal connectors:

Name of Connector	Connects From	Connects To
-------------------	---------------	-------------

(Connectors involving action from more than one type of source)

Line Link Marker Connector - (See Fig. 26, attached)	Line Link Frame	Dial Tone or Combined Marker
--	-----------------	------------------------------

Originating Register Marker Connector - (See Fig. 26, attached)	Originating Register	Combined or Completing Marker
---	----------------------	-------------------------------

Incoming Register Marker Connector	Incoming Register	Combined or Completing Marker
------------------------------------	-------------------	-------------------------------

(Connectors involving action from only one type of source)

Line Link Connector - (See Fig. 27, attached)	Dial Tone, Completing, or Combined Marker	Line Link Frame
---	---	-----------------

Trunk Link Connector - (See Fig. 12, attached)	Dial Tone, Completing, or Combined Marker	Trunk Link Frame
--	---	------------------

Outgoing Sender Connector - (See Fig. 27, attached)	Completing or Combined Marker	Outgoing Sender
---	-------------------------------	-----------------

Number Group Connector - (See Fig. 27, attached)	Completing or Combined Marker	Number Group Frame
--	-------------------------------	--------------------

Pretranslator Connector - (See Fig. 21, attached)	Originating Register	Pretranslator
---	----------------------	---------------

Foreign Area Translator Connector - (See Fig. 28, attached)	Completing or Combined Marker	Foreign Area Translator
---	-------------------------------	-------------------------

3.40 The number of markers in an office determines whether there will be any supplementary connector frames and what type they will be. For offices with six or fewer markers in a subgroup, the connectors are mounted on single-bay frames (called initial frames) which mount from one to four connectors, depending on the type of connector. These initial frames are numbered from 0 up.

3.41 In offices which are expected to serve more than six but less than ten markers in a subgroup, a split supplementary frame which mounts the same number of connectors as two initial frames is provided. It serves three markers (numbers 6 to 8) and is associated with two initial frames. The only exception to this is the trunk link connector split supplementary frame which is provided for every four initial frames.

3.42 In offices which are expected to serve from ten to twelve markers in a subgroup, a regular supplementary frame serving markers 6 to 11 (single bay) which mounts the same number of connectors as the initial frame is added to each initial connector frame. Again, the only exception is the trunk link connector regular supplementary frame which is associated with two initial frames.

#### P. Trunks

3.43 Trunks appear on trunk link frames and carry calls from one office to another and from subscriber to subscriber within the office. Various types of trunks are provided to serve the various types of traffic in an office.

3.44 Trunks are mounted on relay rack frames. Those trunks which require ringing, such as intraoffice, incoming, and revertive ringing trunks, usually have ringing selection switches on the same relay rack. (See Fig. 29, attached.) Ten trunks can appear on each ringing switch.

3.45 The following is a list of principal categories of trunks. Many miscellaneous types are not listed.

3.46 Intraoffice trunks handle traffic between subscribers served by the same marker group. Each trunk requires two trunk link frame locations, an A appearance for the calling subscriber and a B appearance for the called subscriber. These trunks are usually divided into three groups: message rate (AMA or message register), flat rate, and coin.

3.47 Outgoing interlocal trunks are used to transmit calls outgoing from the No. 5 crossbar office to a connecting office. The types of outgoing trunks used depend on the traffic in an individual office. Usually, there is one group of trunks for flat-rate and message-rate traffic and another for coin traffic.

3.48 Incoming interlocal trunks carry the traffic incoming to a No. 5 office. There are two general types of these trunks; namely, nontandem and tandem. The nontandem-type trunks carry only the calls completing to subscribers in the office, and these trunks have one location in the office. This location is on the trunk link frame. The tandem-type trunks carry calls completing to subscribers in the office and also calls which are switched through when the No. 5 office functions as a tandem switching point. Tandem trunks have two frame locations in the office; one on the line link frame for switching calls through and the other on the trunk link frame for calls that terminate in the tandem office.

3.49 Two-way interlocal trunks are provided on small trunk groups when it is impractical to use one-way trunk groups. The trunks may be arranged for either loop or CX (E&M lead) signaling.

3.50 Intermarker group trunks handle traffic between two No. 5 crossbar marker groups located in the same building. The three types of trunks used for this traffic are called:

- (a) Subscriber to subscriber.
- (b) Subscriber to trunk.
- (c) Trunk to subscriber.

3.51 Operator special service and recording completing trunks are used by DSA operators to handle assistance traffic. There are usually separate groups of trunks for various classes of service.

3.52 Tone trunks are used to give line busy on intraoffice calls, overflow (paths busy), partial dial, and vacant code tones. Again there may be coin and noncoin groups of these trunks.

3.53 Common overflow trunks are provided as a final route when all permanent signal holding or noncoin combination tone trunks are busy. This trunk returns an overflow (paths busy) signal to a calling party.

3.54 Intertoll trunks are used to switch toll calls between toll centers. These trunks are of three general types as follows:

- (a) One-way incoming trunks - These have three frame locations in an office; two line link frame locations for calls switched through the No. 5 office as a toll center, and one trunk link frame location for calls terminating in the toll center.
- (b) One-way outgoing trunks - These have one trunk link frame location for calls outgoing from the No. 5 office as a toll center, and one jack location at the toll switchboard for operator-handled outgoing calls.
- (c) Two-way trunks - These have all of the locations mentioned above.

#### Q. Coin Supervisory Circuits

3.55 Coin supervisory circuits handle all the coin operations except those taken care of by the originating register. One of these circuits (which are in a common group and are mounted on relay racks) is connected to a trunk that is serving a coin call. The duties of this circuit are to collect the coins at the end of a completed call for which a charge is made, and to effect coin return when the call is not completed or is one for which no charge is made.

3.56 In offices with coin overtime, this circuit makes coin test and collects the coin for the initial and subsequent periods. If a deposit is not made for an overtime period, the circuit signals for an operator to come in on the connection.

#### R. Coin Supervisory Links

3.57 These links connect coin trunks to coin supervisory circuits. The frame is similar to the incoming register link frame and the circuit arrangements are the same. However, because the holding times of coin supervisory circuits with coin trunks are very short, a group of ten coin supervisory circuits can serve as many as 600 trunks.

#### S. Message Register Frames

3.58 Calls involving one message unit may be recorded by AMA equipment or on message registers. If message registers are used, they are mounted on message register frames.

3.59 Message registration is accomplished over a single-sleeve lead which permits line link frames with 3-wire switches to serve all classes of lines. The message register service charging arrangement involves a cold-cathode vacuum tube. Selective operation of either a tip-party or a ring-party register on 2-party lines is obtained.

3.60 Five hundred message registers and their 500 associated vacuum tubes are mounted on a message register frame as shown in Fig. 30, attached.

#### T. Foreign Area Translators

3.61 A foreign area translator frame and associated connectors contain circuits which operate in conjunction with the markers to permit routing calls to other national numbering areas if there is more than one trunk route available to the numbering area. Arrangements are provided for translation into a maximum of six foreign areas. Where only one route is available to each numbering area, or one combined route is available for a number of areas, the marker can route calls to them without using the foreign area translator. (See Fig. 31, attached.)

### 4. METHOD OF OPERATION

#### A. General

4.01 This part describes, without detailed reference to circuit operations, how the various types of calls in a No. 5 crossbar office are handled by this system. The operation of a No. 5 crossbar office when it is associated with combined toll and DSA switchboards and DSB switchboards, and when it has tandem or toll switching features, is also described.

4.02 The calls in a No. 5 crossbar office are of four general types: intraoffice, reverting, outgoing, and incoming. A dialing connection is established in the office for the first three types of calls, as shown in Fig. 32.

4.03 A call between subscribers with different subscriber lines who are served by the same office is an intraoffice call. The talking connection in the office consists of two channels established between the subscriber lines through an intraoffice trunk, as shown in Fig. 33.

4.04 A reverting call is a call between two subscribers served by the same subscriber line (party line service). The talking connection consists of a channel between

the subscriber line and a reverting trunk, as shown in Fig. 34.

4.05 A subscriber who makes an outgoing call to another office is connected through a channel to an outgoing trunk, as shown in Fig. 35.

4.06 An incoming call to a No. 5 office is connected to the called subscriber by means of a channel between the incoming trunk and the called subscriber, as shown in Fig. 36.

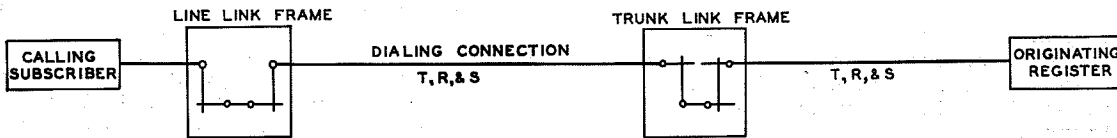

Fig. 32 - Dialing Connection

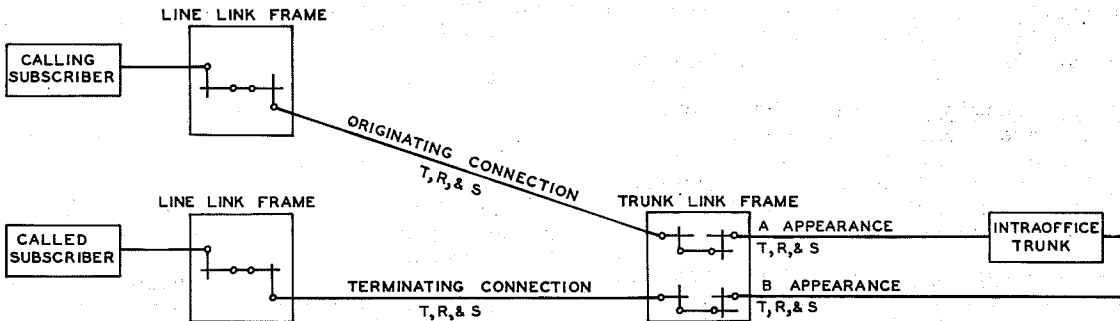

Fig. 33 - Intraoffice Trunk Connection

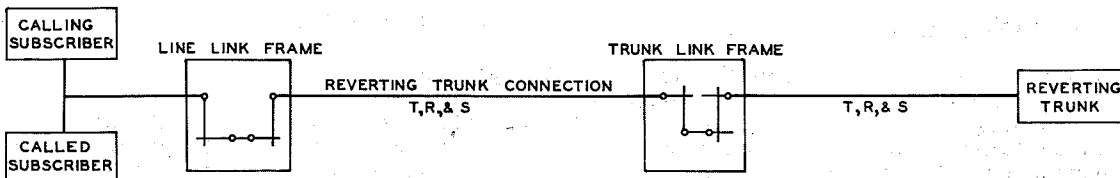

Fig. 34 - Reverting Trunk Connection

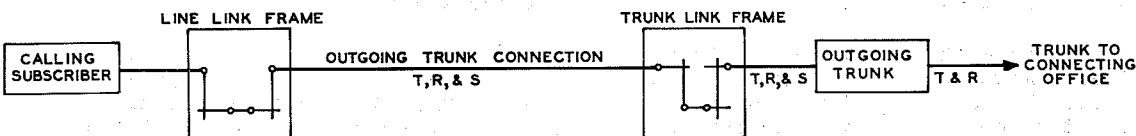

Fig. 35 - Outgoing Trunk Connection

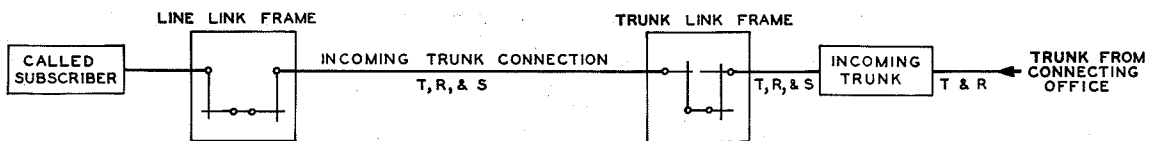

Fig. 36 - Incoming Trunk Connection

## B. Noncoin Calls Not Excluding Message Charging

### Dial Tone Connection

4.07 A dialing connection is established between the calling station and an originating register in the central office after the calling subscriber lifts the receiver from the switchhook. Dial tone, which is the signal to start dialing, is returned to the calling subscriber from the originating register.

### Establishing Dialing Connection

4.08 When a subscriber takes the receiver from the switchhook, a line relay is operated which causes the line link frame to inform the line link marker connector that a marker is required. The line link marker connector selects an idle marker; it then transmits to this marker the identity of the calling line. The only time the line link marker connector seizes a marker is when a dialing connection is to be established. (See Fig. 37, attached, connection 1.)

4.09 In order to establish a dialing connection between the subscriber line and an idle originating register, the marker must determine:

- (a) The class of service and equipment location of the calling line; that is, the line link frame number and the location of the line on that frame.
- (b) Whether an idle register is available and the number of the trunk link frame on which it appears.
- (c) That a channel between the line and the register can be obtained.

The calling line class of service and equipment location is stored in the originating register by the marker for subsequent use on marker intraoffice or outgoing trunk jobs.

4.10 The equipment location of the calling line is identified in terms of the line link frame number, the vertical group, the horizontal group, and the vertical file numbers.

4.11 A vertical group of subscriber lines is five verticals wide and ten switches high for a total of fifty lines. Thus, the

number of vertical groups of a line link frame will vary from six for a 290-line frame to twelve for a 590-line frame. A horizontal group is one switch high and extends across all the vertical groups of a frame. There are always ten horizontal groups on a frame. A vertical file is one vertical wide and ten switches high for a total of ten lines. The number of vertical files on a frame depends on the number of lines on that frame. The division of the frame into vertical groups, horizontal groups, and vertical files is illustrated in Fig. 38, attached.

4.12 The number of the line link frame, of the vertical group, and of the horizontal group in which the line appears is transmitted to the marker via the line link marker connector. Therefore, at this point, the calling line location is determined to within five lines. The other piece of information required by the marker to completely identify the line location within the frame is the vertical file number. This is obtained, as discussed later, from the line link frame through the line link connector which is another connector directly associated with the frame.

4.13 While the marker is recording the above information (except for the vertical file number), it is also selecting an originating register. Originating registers are distributed as equally as possible over all the trunk link frames and an idle register is selected in the same manner as an idle trunk. The marker is notified by means of test leads from each trunk link frame which frames have at least one idle register and are not being held busy by other markers. It selects, in a preference sequence, an idle frame having one or more idle registers and connects to that frame through a trunk link connector. (See Fig. 37, attached, connection 2.) The marker then selects an idle register on that frame in a preference sequence.

4.14 After the marker selects a trunk link frame, it goes back to the line link frame via the line link connector. Each line link frame has a line link connector which carries the leads for vertical file identification (previously mentioned) and other leads, which the line link marker connector does not have, for completing connections to

the frame (connection 3). The vertical file number is transmitted to the marker which now has all the data for locating the position of the line on the line link frame, namely: vertical group, horizontal group, and vertical file numbers.

4.15 Identification of the class of service of the calling line is passed to the marker from the line link frame via the line link connector after the vertical file number has been recorded. Class-of-service identification is through a vertical file, and there is a maximum of thirty classes of service per marker group. The assignment of a vertical file to a class of service is on a cross-connection basis. Therefore, any class of service can be assigned to any vertical file. The marker transmits the equipment location and class of service of the calling line to the originating register where this information is stored.

4.16 The marker now must select an idle channel between the subscriber line and the originating register. A channel consists of a line link, a junctor, and a trunk link. Channels are arranged in groups of ten so that the marker can check ten channels at one time. If the number of channels in an office is not divisible by ten, one group will have nine or fewer channels in it. When the marker finds an idle channel, it operates the select and hold magnets required to close through the channel. The marker then indicates to the originating register the identity of the line link used in the channel, and the register stores this information for later use.

4.17 Before the marker transfers control of the channel to the originating register, it checks the connection for continuity (connection 4). The marker then releases its associated connectors and itself and leaves in the register the calling line equipment location in terms of the line link frame number, vertical group number, horizontal group number, and vertical file number, and also registers the number of the line link used in the dialing connection and the class of service of the calling line. The register now furnishes dial tone to the subscriber and is ready to receive the digits which are dialed. As soon as its function is completed, each item of equipment is released.

4.18 The digits which the subscriber dials are registered in the originating register. As soon as dialing is completed, the originating register seizes a marker and transmits the registration to it.

4.19 It normally takes less than half a second to establish the dialing connection and return dial tone to the calling subscriber.

#### Pretranslation

4.20 Pretranslation is the process of determining from the first one, two, or three dialed digits how many more digits the register should expect to receive on the particular

call. It is called pretranslation because it takes place before marker translation and is required when the total number of digits in the office codes within the range of customer dialing varies and when some called numbers have party letters.

4.21 Where the volume of calls of this nature is not great and the numbering plan is not too complex, pretranslation can take place in the originating register. The register can be arranged to determine how many digits it should receive from the first digit or from a limited combination of the first and second digits.

4.22 For more complex numbering plans, a separate pretranslator circuit is provided. This circuit is called in by the pretranslator connector when the first two or three digits have been set in the originating register. The pretranslator determines from these digits how many more should be dialed and tells the register that it must wait for these before it calls in a marker.

4.23 On calls to stations where a party letter is part of the directory number, the register has to wait for an extra digit. This situation is known as stations delay. The pretranslator recognizes stations delay from the dialed code and informs the register to wait for a possible additional digit.

4.24 A uniform numbering plan without party letters or ringing digits eliminates the necessity for pretranslation.

#### Intraoffice Calls

##### General

4.25 When the calling subscriber removes the receiver from the switchhook, the dialing connection is established as described above. After the number is dialed, the originating register engages a marker through an originating register marker connector. (See Fig. 39, attached, connection 1). The register then transmits the line equipment location of the calling line and the digits of the called number to the marker. The marker translates the office code and determines that the called number is assigned to the same marker group as the calling line.

4.26 The marker then proceeds to perform an intraoffice trunk job which consists of two parts, the establishment of a terminating and an originating connection. The terminating connection is set up between the called line and the B appearance of the intraoffice trunk; the originating connection is set up between the calling line and the A appearance of the trunk.

##### Establishing Terminating Connection

4.27 The terminating connection is established first so that if the called line is busy, the marker can immediately con-



nect the calling line to a tone trunk and thus save holding time on equipment. Before the terminating connection can be set up, the marker has to obtain the following information from the number group:

- (a) The equipment location of the called number.
- (b) The setting of the ringing selection switch.
- (c) Whether terminal hunting is necessary.

#### Nonterminal Hunting

4.28 The marker gains access to the number group through the number group connector. (See Fig. 39, attached, connection 3.) The proper number group frame is selected from the dialed thousands digit and the hundreds, tens, and units digits of the called number are transmitted to it. The number group frame translates these digits into an equipment location in terms of line link frame vertical group, horizontal group, and vertical file numbers and transmits this information to the marker. The number group also informs the marker as to the correct setting of the ringing selection switch for ringing the called number. The ringing codes appear on the horizontals of the ringing selection switch while the trunks appear on the verticals and the marker operates the select and hold magnets in order to connect individual or proper party-line ringing to the trunk.

4.29 While the marker is obtaining this information from the number group, it is also selecting an intraoffice trunk on an idle trunk link frame (connection 2). Through the line link connector, the marker gains access to the line link frame on which the called subscriber line is located (connection 4). If it is not busy, the terminating connection is set up between the B appearance of the intraoffice trunk on the trunk link frame and the called line (connection 5).

4.30 If there is no idle channel available, the marker recycles by releasing the intraoffice trunk it was holding and selecting another one (usually on another frame). If there is no idle channel on this recycle, the marker reroutes the call to a tone trunk.

#### Terminal Hunting

4.31 A subscriber who has more than one terminating line is assigned one directory number per line with usually only the lowest number listed in the directory. These lines, which form a terminal hunting group, are usually consecutively numbered. If the listed number is called and is busy, the marker tests the next higher number in the group and completes the call to the lowest idle number. The marker hunts in the same manner if one of the intermediate numbers is called and is busy.

4.32 Each number group is divided into ten hundreds blocks, each containing ten blocks of ten numbers. One hunting group can spread over more than one hundreds block or more than one tens block. Two or more hunting groups other than blank number or intercept trunks may appear in any tens block. Non-hunting terminals may appear in the same tens block with hunting groups except as noted below. Where there are more than ten trunks but less than one hundred, the "block select" method can be used. By this method, the marker hunts first through the lines located in the directory number tens block, and finding them all busy, will select the lowest block containing at least one idle line without testing the intermediate blocks containing all busy lines. The allotted PBX hunting group feature can also be used. With this feature, the line numbers of a hunting group may be assigned in more than one number group (eight number groups maximum). The marker recognizes the thousands, hundreds, and tens digit before connecting to any number group and steers the call to a tens block on a preferred number group containing idle lines to the PBX. Because the marker does not look at the units digit initially, the tens block containing the listed directory number must not contain numbers of any other subscriber. The latter two plans require an auxiliary relay per PBX trunk.

#### Establishing Originating Connection

4.33 After the terminating connection is established, the marker proceeds to set up an originating connection between the calling line link frame and the A appearance of the intraoffice trunk on the trunk link frame over an idle channel (connection 7). The marker seizes the line link frame of the calling subscriber, as shown in connection 6. Before it releases the dialing connection, the marker determines whether there is an idle channel between the calling subscriber and the A appearance of the intraoffice trunk. If there is an idle channel, the dialing connection is released immediately, enabling the marker to use the dialing connection line link as part of the originating connection, if necessary. However, if there is no idle channel available, the marker recycles as described above. In case no idle channel is found on the recycle, overflow tone is returned from the originating register through the dialing connection.

4.34 After the marker sets up the ringing selection switch in the terminating connection in accordance with the information obtained from the number group, it releases itself and the originating register from the intraoffice connection. The dialing connection is disengaged and the subscribers are interconnected. The trunk now controls the ringing and supervision of the call. The ringing is tripped when the called party answers and the ringing selection switch releases. When the call is finished, the originating and terminating connections are broken and the intraoffice trunk is released.

Timed-release Feature

4.35 A timed-release feature is provided in order to prevent the calling party from holding the called line out of service indefinitely by failing to hang up the receiver. In this case, the timed-release feature automatically disconnects the calling line 13 to 35 seconds after the called subscriber hangs up. If the calling subscriber disconnects first and the called subscriber fails to disconnect, the timed-release feature disconnects the called party after 13 to 35 seconds.

Interoffice Calls - Outgoing

General

4.36 Outgoing calls are established to subscribers in a connecting office or to operators (toll, assistance, and service code calls; Fig. 43, attached). Calls to connecting offices require the services of an outgoing sender; assistance and service code calls usually do not.

Establishing Outgoing Trunk Connection

4.37 When the subscriber has dialed the called number, the originating register engages a marker via an originating register marker connector. (See Fig. 40, attached, connection 1.) The register transmits the following information to the marker: the equipment location and class of service of the calling subscriber, the number of the line link frame used in the dialing connection, and the called number.

4.38 From the office code, the marker learns:

- (a) That the call is to be completed to a connecting office and requires a marker outgoing trunk job.
- (b) What type of pulsing that office requires (multifrequency, dial, revertive, or panel call indicator pulsing).

By means of the outgoing sender connector, the marker gains access to an outgoing sender that sends the type of pulses which the connecting office receives (connection 2).

4.39 When the outgoing sender connector is engaged, the marker, by means of the trunk link connector, gains access to an idle trunk link frame and an outgoing trunk on that frame (connection 3). The sender is now connected to the marker through the outgoing sender connector, and receives the called number from the marker. The marker also sets up a connection between the outgoing trunk and the outgoing sender through the sender link.

4.40 As soon as the trunk link frame is seized, the marker connects to the line link frame of the calling subscriber (connection 4) and establishes a channel between the subscriber and the outgoing trunk (connection 5). The dialing connection is released if the marker

finds an idle channel and the line link used in the dialing connection may be reused in the outgoing connection in the same manner as for the intraoffice call. If there is no idle channel available, the marker recycles the call by releasing the outgoing trunk it was holding and selecting another one. If there is no idle channel on this recycle, the marker reroutes the call to a tone trunk on a trunk link frame.

4.41 The outgoing sender then makes trunk test. If trunk test fails, overflow tone is returned to the subscriber from the trunk. As in an intraoffice call, the marker releases upon completion of its functions. The sender transmits the called number to the connecting office and then disconnects itself and the sender link. The outgoing trunk maintains supervision of the call.

- (a) The DP outgoing sender is arranged (optionally) to prefix up to three arbitrary digits when the call is routed through a distant tandem point which consumes the prefixed digits in completing the connection to the office of destination. The sender is also arranged to delete some of the digits originally dialed by the customer.

Interoffice Calls - Incoming

General

4.42 An incoming call is the continuation and completion in a called office of an outgoing call from a connecting office. In the called office, the trunk from the originating office is termed an incoming trunk. The incoming connection consists of a channel between an incoming trunk and the called subscriber.

Establishing Incoming Trunk Connection

4.43 As soon as the incoming trunk is activated by a call originating in a connecting office, it seizes an incoming register through an incoming register link. (See Fig. 39, attached, connection 1.) Separate groups of incoming registers are provided for each type of pulsing that the office is equipped to receive (multifrequency, dial, or revertive pulsing).

4.44 After the idle trunk is seized in the called office, the incoming register is connected to the incoming trunk and then receives the numerals of the called number. (In this example, it is assumed that the trunk is used for completing calls to only one of several offices which may be served by a marker group.) The register records the number of the trunk link frame on which the incoming trunk appears in order that the marker will later be able to reach that incoming trunk. After the numerals of the called number have been registered, the register gains access to a marker through an incoming register marker connector (connection 2) and transmits the called digits and the trunk link frame number to it.

4.45 The marker first seizes the trunk link frame (connection 3) and then selects the proper number group frame from the called thousands digit (connection 4). The number group translates the called hundreds, tens, and units digits. As soon as the marker determines the called line location from the number group, it seizes the proper line link frame and performs the line-busy test on the called line (connection 5).

4.46 If the called line is idle, the marker sets up a channel between the trunk and the called line (connection 6). Utilizing the ringing code information it has obtained from the number group, the marker sets the ringing selection switch. If the marker cannot find an idle channel, it sets the incoming trunk to reorder signal and releases itself from the connection.

4.47 As soon as the marker has finished the above functions, it disconnects the incoming register, the register link, and itself from the connection. The trunk now controls the ringing and the further supervision of the call. The ringing selection switch vertical releases when the called party answers or the call is abandoned.

4.48 If the called line is busy, the marker sets up a busy signal in the incoming trunk. The marker then releases the incoming register, the register link, and itself from the connection.

### Reverting Calls

#### General

4.49 A reverting call takes place between subscribers who share the same party line. The talking connection is set up between the subscriber line and a reverting trunk when the class of service of the calling subscriber line is flat rate, and when reverting trunks are provided in the office.

4.50 When the class of service of the calling subscriber line is flat rate and reverting trunks are not provided in the office, it is necessary to connect the calling subscriber to an operator over an outgoing trunk to the toll and DSA switchboard. The operator obtains the called subscriber and supervises the connection.

4.51 When the class of service of the calling subscriber is message rate, it is necessary to connect the calling subscriber to an operator regardless of whether or not the office is equipped with reverting trunks. The operator, in addition to obtaining the called subscriber and supervising the call, makes the necessary charge. This operation is employed because the reverting call trunks are not arranged to provide automatic message charging.

#### Establishing Reverting Trunk Connection

4.52 The calling subscriber receives dial tone and dials in the usual manner. The originating register transmits the calling subscriber line location and class of service, and also the called number to a marker which recognizes that number as belonging to the same office. (See Fig. 42, attached, connection 1.) The marker then proceeds to seize both the proper number group and an intraoffice trunk (connections 2 and 3). Up to the point that the marker checks the number group for the called line location, a reverting call is handled in the same manner as an intraoffice call.

4.53 However, as soon as the marker determines from the number group that the called line location is the same as that of the calling line, it releases the intraoffice trunk. The marker then seizes a trunk link frame on which an idle reverting trunk appears (connection 4) and sets up a channel between the subscriber line and that trunk (connections 5 and 6). After the marker sets up the proper ringing codes in the reverting trunk, it releases itself from the connection. The reverting trunk is now left in control of the call.

4.54 There are two types of reverting trunks:

- (a) Those used for 2-party selective, 4-party semiselective, and 10-party divided code ringing.
- (b) Those used for 2-party selective, 4-party full-selective, and 8-party semiselective ringing.

Depending on its individual needs, an office may have one or both types of these trunks.

#### 2-party Selective Lines (Using Type (a) Trunk)

4.55 In the case of a tip subscriber calling a ring subscriber on a 2-party line, the trunk returns a busy signal to the tip subscriber who hangs up. The trunk then applies regular ringing to the called party and a reverting ringing signal (1/2 second on, 2-1/2 seconds off) to the calling subscriber. When the called subscriber answers, the ringing is tripped; this notifies the calling party to lift the receiver and start talking.

#### 4-party Semiselective and 10-party Divided Ringing Lines (Using Type (a) Trunk)

4.56 The method of operation on these lines is the same as that used on 2-party lines except that the trunk rings all parties on one side of the line. Since each subscriber on the same side of the line has a separate ringing code, only one of the parties will answer.

#### 2-party Selective, 4-party Full-selective, and 8-party Semiselective Lines (Using Type (b) Trunk)

4.57 When a subscriber on a 4-party full-selective or an 8-party semiselective line wishes to call another party on his line,

he dials the called number. The originating register engages a marker which connects to a reverting trunk in the same manner as described above and sets the ringing switch for the called station. The trunk then supplies a steady high tone to the calling subscriber; this tone notifies the subscriber to dial an additional digit which is associated with his station for use on reverting calls. From this digit, the trunk selects the individual ringing position for the calling station. After the extra digit is dialed, the trunk supplies busy signal to the calling station. The calling subscriber hangs up and the trunk proceeds to ring the called and calling stations alternately.

4.58 When the called station answers, the ringing is tripped. This notifies the calling subscriber to remove the receiver and start talking. When both subscribers hang up, the equipment returns to normal.

#### Assistance and Service Code Calls

##### General

4.59 Calls for which a subscriber dials zero or a service code are completed over channels between the calling subscriber and an appropriate outgoing trunk. (See Fig. 43, attached.) When there are direct trunks to the operator positions, no outpulsing is necessary, and therefore, outgoing senders are not required in the connection. However, service code calls may sometimes be handled through a centralized point, and in that case, an outgoing sender is required to outpulse the dialed digits.

4.60 Pretranslation is not necessary because the originating register is equipped to recognize the zero and service codes directly.

##### Assistance Calls

4.61 When making a zero call to the operator, the subscriber dials after receiving dial tone. The originating register records this single digit, and without waiting for any more, engages a marker (connection 1). The marker establishes a channel between the calling line and an outgoing trunk to an operator and releases itself (connections 2, 3, and 4). The subscriber hears an audible ringing signal until the operator answers. After the operator has connected to the trunk, the circuit is so arranged that even if the subscriber hangs up, the operator can still hold the connection. This prevents any accidental manipulation of the switchhook from destroying the connection.

##### Service Code Calls

4.62 Calls to a service code operator (business office, long distance, repair service, etc.) follow a similar pattern. When the originating register receives the service code digits, it engages a marker and transmits them to it. The marker then sets up a channel between the calling subscriber and an out-

going trunk to the proper operator or desk and releases. The subscriber hears an audible ringing signal until the operator answers. When the subscriber hangs up, the connection is released.

#### Manual Calls

4.63 A dial office may also serve some manual subscribers who require the assistance of an operator on all originating calls.

4.64 When a manual subscriber lifts the receiver from the switchhook, the line link marker connector engages a marker. At the same time that it is receiving the line link frame location and the class of service of the calling line from the connector, the marker selects an idle originating register as though the call were from a dial station. The marker transmits the above information to the register and releases. No dial tone is returned to the subscriber because the register recognizes the class of service of the calling line as manual. The originating register then seizes a marker and indicates that a connection to an operator is required. The marker establishes a channel between the calling manual subscriber and an outgoing trunk to a DSA operator. The operator then completes the call at the request of the subscriber.

#### Dialing Into an Adjacent Area

4.65 One of the features of the No. 5 crossbar system is a means whereby subscribers served by an office in one numbering area can dial directly into an adjacent numbering area even when the same office codes are used in both areas. Where such an arrangement is provided, a directing code which identifies the called area must be dialed before the called directory number. The primary purpose of this directing code is to avoid any confusion from any conflicting codes in the two areas. The marker in the calling office is arranged to recognize the directing code and to set up a connection to an outgoing trunk that goes directly to the called adjacent area.

4.66 The No. 5 crossbar system is so designed that customers may dial into all the numbering areas now in use in the United States and Canada. The calling customer dials first the 3-digit national area code of the numbering area of the called customer then the 7-digit directory number of the called customer. The marker in translating the area code, establishes the connection to a trunk directly to a switching center in the area dialed or to an intermediate toll switching point which will select a route to the area dialed. Where more than one route is available from the No. 5 crossbar office to a particular area, the marker determines from its foreign area translator which route to use to the particular office. It is likely that customer dialing access will be limited to 2-letter, 5-digit numbering plan areas.

Various Call Conditions

## Permanent Signal

- 4.67 A permanent signal may result from faulty handling of the station equipment or from trouble conditions in the telephone plant.
- 4.68 After dial tone has been sent to the calling line, the originating register waits for dialing to start.
- 4.69 The register allows 20 to 35 seconds, under normal traffic conditions, for the receipt of the first digit. If it does not receive the first digit in that time, the register refers the call to a marker as a permanent signal. The marker then connects the calling line to a permanent signal trunk. Before releasing, the marker indicates to the trunk whether the calling line is coin, PBX, or a noncoin, non-PBX class.
- 4.70 The signal first appears before an operator. The operator challenges on the trunk, and if she receives no answer, takes the necessary action as covered by local instructions.

## Partial Dial

- 4.71 After the dialing connection has been established and dial tone is transmitted to the subscriber, the originating register waits for the dialed digits. The register waits 20 to 35 seconds, under normal traffic conditions, for the first digit and the same length of time for each succeeding digit.
- 4.72 If the subscriber fails to dial a digit within this specified time interval, the register refers the call to a marker as a partial dial. The marker may handle the situation in one of two ways:
- It may connect the calling line to a tone trunk.
  - It may connect the calling line to an outgoing trunk which terminates before an operator.

The method that is used depends on the procedure followed in the individual office.

## Dialing Before Receipt of Dial Tone

- 4.73 If a subscriber starts dialing before receiving dial tone, one of the following situations will occur:
- The first digit may be distorted so that the originating register will record an incorrect code.
  - The register will record an insufficient number of digits.
- 4.74 In the first case, if the code which the register records is a working one, the calling subscriber may get a wrong number.

However, if the digits recorded by the originating register constitute a vacant code (a code not in current use), the calling party will be connected either to an operator or to a tone trunk.

- 4.75 If pretranslation is provided in the originating register, the register recognizes the vacant code and engages a marker as soon as the first three digits have been dialed. The marker receives the vacant code digits from the register and routes the call to an operator or a tone trunk.
- 4.76 If pretranslation is not provided, the originating register does not recognize the vacant code; therefore, it waits for the full directory number before it engages a marker. The marker then recognizes the vacant code and routes the call as described above.
- 4.77 In the second instance, where an insufficient number of digits are recorded, the call is treated as a partial dial.

## Intercepting

- 4.78 A call is intercepted if it is made to any of the following:
- A subscriber whose telephone has been temporarily disconnected or whose number has been changed.
  - A subscriber whose telephone is out of order and arrangements have been made to intercept incoming calls.
  - A subscriber whose telephone has been permanently disconnected.
  - An unassigned number.
  - A blank number.
  - Vacant code (when handled by operator).

4.79 When a number, which is on intercept for reasons (a) or (b) above, is called, the calling party is routed to an intercept operator over an intercept trunk. Each intercept trunk has a line link appearance and is assigned a number in a number group; these numbers are in a terminal hunting group. Therefore, on an intraoffice or incoming call, when the marker seizes the number group and finds that the called number is on intercept, it goes to an intercept trunk group (which may be on the same or a different frame) and obtains the equipment location of an intercept trunk. Through a line link connector, the marker seizes the line link frame on which the trunk appears and establishes a channel between the calling line and the intercept trunk. The other appearance of this trunk is before an intercept operator.

4.80 Blank numbers, permanent disconnects, and unassigned numbers are also treated in this manner, except that a recorded announcement may be connected to the other end of the trunk. Unassigned numbers are numbers

in an office which are not currently assigned to subscribers; blank numbers are numbers which do not exist in the office at all.

4.81 For example, in an office which is equipped to serve 5000 directory numbers, there are always some numbers within the 5000 which are not allotted to subscribers. When such numbers are dialed, the marker, after learning from the number group that the number is on intercept, connects the calling subscriber to an intercept operator or a recorded announcement.

4.82 If, using the same office as an example, a subscriber dials a number above 5000, this is called a blank thousands number. When such a number is dialed, the marker recognizes it immediately and connects the calling subscriber to an intercept operator or a recorded announcement.

### C. Message Charging on Coin and Noncoin Calls

#### Prepayment Coin Service

4.83 There are two types of prepayment coin service: coin first (the most common) and dial tone first. With coin first service, a coin must be deposited before dial tone is returned to the calling party. Conversely, with dial tone first service, dial tone is returned when the receiver is removed from the switchhook; a check for coin deposit is made after dialing is completed. Only coin first, ground start service is discussed here, which is required for 10-cent coin operation.

4.84 With ground start operation, the customer is connected to an originating register after a coin is deposited. When dialing is completed, the originating register engages a marker and transmits the usual information to it, including the coin class of service of the calling party. The marker then establishes a connection between the calling party and a trunk arranged for coin operation.

4.85 The answer of the called subscriber sets the charge condition in the trunk. If the office has no provision for overtime charging, the collection of the coin is made when the calling subscriber disconnects at the end of the call. For example, when the called subscriber takes the receiver off the hook, the battery and ground on the trunk pair is reversed. When the receiver-off-the-hook situation persists for the charge delay interval of 2 to 5 seconds, the charge condition, which determines that the calling party will be charged for the call, is set in the trunk.

4.86 Busy and overflow signals are also returned by reversing the battery and ground, but this is a flashing reversal under the control of an interrupter which usually supplies interruptions at 60 ipm for busy signal and 120 ipm for overflow. Therefore, the

reason the final charge condition is not set in the trunk until the 2- to 5-second interval of uninterrupted battery and ground reversal has elapsed is to prevent false charging on busy and overflow reversals.

4.87 On an intraoffice call, the 2- to 5-second charge delay interval is the same but the charge condition is locally set in the trunk.

4.88 When the calling party disconnects, the trunk used in the talking channel associates itself with a coin supervisory circuit through a coin supervisory link. (See Fig. 44.) The coin supervisory circuit then tests for and collects the coin if the charge condition has been set; if it has not, the coin is returned.

4.89 After coin collect or return is made, the coin supervisory circuit again tests for the presence of the coin ground. If the coin ground is found to be still in the box, the circuit signals a stuck-coin condition to an operator. From the signal, the operator knows whether the coin should be collected or returned and tries to dispose of the coin. If this is unsuccessful, the line is considered out of order because of the stuck-coin condition and is referred to the maintenance department.

4.90 When the circuits are arranged for coin overtime, an additional charge is made for each 5-minute interval of conversation beyond the initial 5-minute period. The trunks are equipped with interval timers and cause the coin to be collected 4-1/2 minutes after the charge condition has been set. At this time, a tone is put on the connection for one-half second to remind the calling party that another coin must be deposited if the conversation is to continue beyond the next half minute without interruption. At the end of 5 minutes, if the connection has not been released, the coin supervisory circuit is again connected to the trunk to test whether a coin has been deposited for overtime. If it has been deposited, the coin control circuit releases itself and allows the conversation to continue without interruption; if not, an operator is signaled in on the connection and she requests an additional coin. The coins for overtime service are collected at the 4-1/2-minute point of each 5-minute interval. These intervals are shown in Fig. 45. If another coin is deposited after the 4-1/2-minute signal but the connection is released before the full 5 minutes have passed, this coin is returned by the coin supervisory circuit.

4.91 On 0 and 211 calls, the initial deposit is returned by the trunk when the operator answers or if the customer hangs up before the operator answers. If it is desired, 0 trunks may be adjusted to retain the coin on operator answer.

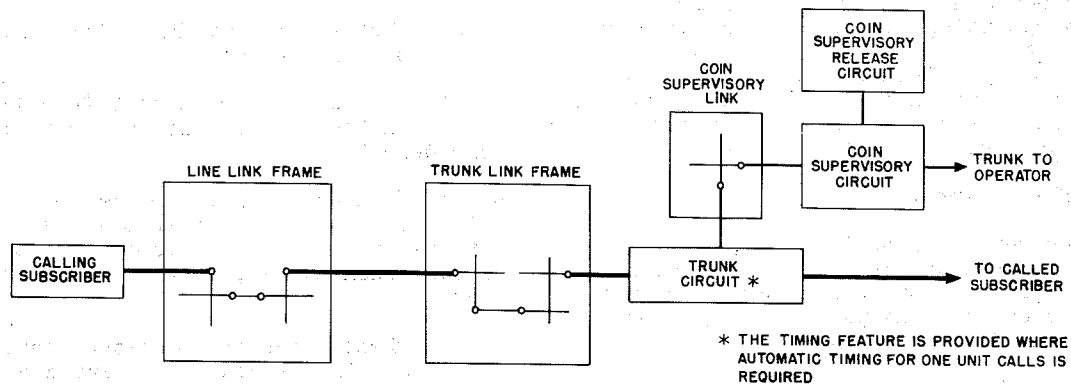

Fig. 44 - Association of Coin Trunk and Coin Supervisory Link

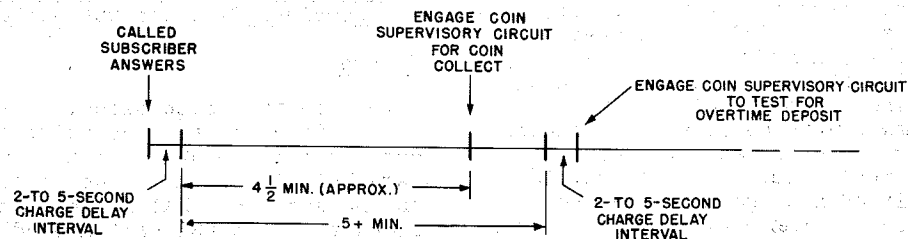

Fig. 45 - Intervals for Coin Operation With Overtime

4.92 On service codes and all other calls except as mentioned, the trunks call in coin supervisory circuits to dispose of the coins.

#### Trunking for Coin Calls

4.93 Separate groups of trunks are provided on an alternate route basis for handling outgoing interoffice calls dialed from coin lines. The types of trunks and the method of operation are discussed in M, Coin Junctor Operation.

#### Message Register Service

##### General

4.94 Message register charging, as an alternate method for recording calls to one message unit areas, is handled by means of an individual message register located in the central office and directly associated with a subscriber line. Message registers can be assigned only to individual and 2-party lines and are operated on calls for which the subscriber is charged. With this type of service, the subscriber charges are based on the number of operations of the message register. Provision can be made for overtime charging according to the needs of each office.

4.95 Message registers are operated on calls to one message unit areas only. Calls beyond the one message unit area must be handled through an operator or AMA equipment.

4.96 Flat rate subscribers do not have message registers attached to their lines because they are allowed an unlimited number of calls in their flat rate calling area and all calls involving message charging are handled by an operator or AMA equipment.

##### Message Rate - Individual

4.97 Originating register operation is the same for individual message rate and flat rate subscribers. When a message rate subscriber finishes dialing, the originating register engages a marker and transmits the class of service of the calling line to it. If the call is not for a free code, the marker seizes a trunk link frame that has trunks arranged for message rate operation.

4.98 When the called subscriber answers and the supervision on the trunk has been reversed for 2 to 5 seconds, the charge condition is set in the trunk. The message register is then operated by the trunk, which controls the supervision of the call, and the call is

completed in the usual manner. An office may provide for overtime charging on non-zone calls or this feature may be omitted. In offices which do charge for overtime, a message charge is made for each 5-minute period by operating the message register once at the start of conversation and again at the beginning of each 5-minute period. Five-minute timing switches are provided in trunks equipped for message register operation in order to control overtime charging.

#### Message Rate - Two Party

4.99 Each 2-party line is arranged for the attachment of both a tip and a ring message register. One register records the calls made by the ring party and the other those made by the tip party.

4.100 When the marker receives a 2-party class-of-service indication, it passes the information on to the originating register. The register then makes party identification test to determine whether the tip or the ring subscriber is making the call. The tip party is identified by a 1000-ohm ground on the line; the ring station is identified by the absence of such a ground. To protect against false 2-party identification due to manipulation of the switchhook, the originating register makes the party-line identification test twice, once before dial tone is transmitted and again before the register engages a marker to complete the call.

4.101 The talking connection is established to a trunk arranged for 2-party message rate operation. The marker then sets the charge condition for either the tip or the ring party in the trunk. After the called subscriber answers and the charge delay interval elapses, the message register is operated. As on individual lines, provision can be made for overtime charging. The call is completed in the same manner as a flat rate call.

#### AMA Service

##### General

4.102 AMA equipment is also used to record elements of charging information on calls involving one or more message unit charges or toll charges. The detailed description of the AMA system is given in the reference designated in 1.02. Outgoing trunks that carry charged calls are associated with an AMA recorder and perforator in groups of 100 or less trunks per recorder. When a non-coin customer dials an office code or national area code that involves a message or toll charge, he is connected to a trunk which can connect him to the distant point. At the same time the following details of the call are recorded on the punched tape:

- (a) Trunk number
- (b) Calling number
- (c) Called number

- (d) National area code
- (e) Message billing index
- (f) Other miscellaneous detail

4.103 The recorder is then released for use by other trunks.

4.104 If the call is to be bulk billed, the called number, national area code, and some details are omitted.

4.105 When the called party answers and the conversation terminates, separate entries are made on the tape, each consisting of the trunk number, the time, and an entry index.

4.106 These tapes are processed through the accounting center at periodic intervals. From the basic data on the tape, the subscribers calls are tabulated and arranged in numerical order of telephone numbers.

#### D. Operation of No. 5 Crossbar Office With Combined Toll and DSA Switchboard

##### General

4.107 In this discussion, the switchboard is considered as being a combined toll and DSA switchboard, and also as being in the same building with the No. 5 crossbar office. In the sections that follow, the terms "combined toll and DSA switchboard" and "switchboard," and also the terms "combined toll and DSA operator" and "operator" are synonymous.

4.108 The only difference between having the switchboard in the same building or in another building is in the type of trunks used. Otherwise, the method of operation is the same for both conditions.

4.109 The types of calls which may be handled by switchboard operators are shown by Fig. 46. Some service code calls are answered by the information operator, repair clerk, etc., instead of by the toll and DSA operator. Permanent signal, partial dial, and vacant code calls appear at the switchboard or are routed to tone trunks, according to the practice in individual offices.

4.110 Each incoming trunk to the switchboard has a lamp appearance before an operator which signals her to answer the call and take the appropriate action. This operator has access to various types of outgoing trunks over which calls are extended from the switchboard.

4.111 If the traffic warrants it, there are straightforward trunks to manual offices from the switchboard. There is no pulsing over these trunks. When an operator plugs into such a trunk, an idle operator at the other end is signaled and she connects to the trunk. This causes a zip tone to be sent to the originating operator, signaling her to pass the called number.



4.112 Wherever the traffic is heavy enough, direct or tandem trunks are provided between the switchboard and certain connecting offices. The operator can key or dial the called number directly into these outgoing trunks and reach the connecting office without going through the No. 5 crossbar office.

4.113 There are also operator junctors and trunks arranged for pulse conversion outgoing from the switchboard. The operator can handle operator assistance completing traffic by means of these trunks.

#### Assistance and Long Distance Calls

4.114 A dial subscriber who desires the service of an operator in order to make a long distance call or to complete a local call dials the long distance code or 0 and is routed to a combined toll and DSA operator. A manual subscriber need only lift the receiver from the switchboard to be connected to an operator. Some of the duties of an operator are:

- (a) To complete calls for subscribers who require assistance.
- (b) To check complaints about called numbers which are continuously busy or unanswered.
- (c) To complete calls to numbers beyond the subscriber's dialing area.
- (d) To complete calls to manual offices within the local service area where these offices are not arranged for call indicator operation.

#### Call From Switchboard Completed to No. 5 Crossbar Subscriber

4.115 The operator can complete calls to subscribers in the No. 5 crossbar office over toll switching trunks. These trunks have two locations: one at the switchboard and the other on a trunk link frame. (See Fig. 47, attached.)

4.116 The operator plugs into a toll switching trunk (connection 1). The trunk is connected to an incoming register through an incoming register link (connection 2). The operator keys the four numericals. (A directing digit is prefixed if the trunk serves more than one office code.) The call then proceeds like a regular incoming call (connections 3, 4, 5, 6, and 7).

#### Call From Switchboard to a Connecting Office

4.117 By means of a trunking arrangement called an operator junctor, an operator located in the same building as the No. 5 office can gain access to the outgoing trunks in that office. This operator junctor operation is discussed in L of Part 4.

#### Pulse Conversion Outgoing Calls

4.118 A combined DSA and toll switchboard, located in the same building as the No. 5 crossbar office which it serves, may have, if the traffic warrants it, direct trunks to a connecting office which receives only dial or revertive pulsing. These trunks are provided for calls that require the assistance of an operator. By means of a process known as pulse conversion, the operator can complete a call from the No. 5 crossbar office to such a connecting office.

4.119 Pulse conversion is the action of converting MF pulsing received from a switchboard position to the type of pulsing required by the office to which the call is completed. This type of pulse conversion requires that these pulses be converted to either dial or revertive pulses, whichever are required by the connecting office. This method of completing calls to a connecting office from a DSA switchboard is economical and efficient for three reasons:

- (a) No junctors are used in the connection.
- (b) The operator just keys the numericals of the called number into the trunk when completing to a local office. (Directing digits are prefixed if the trunk serves more than one office code.)
- (c) The switchboard sender for converting pulses to the proper type is eliminated.

4.120 A pulse conversion trunk first operates as an incoming trunk by seizing a MF incoming register and passing pulses to it. Later, it acts as an outgoing trunk by connecting to a dial or revertive pulse outgoing sender and transmitting the required type of pulses to the called office.

4.121 The calling subscriber reaches the DSA operator in the usual manner and tells her the called number. From this information, the operator plugs into a trunk arranged for pulse conversion outgoing to the called office. (See Fig. 48, attached, connection 1.) Through an incoming register link, the trunk is connected to a MF incoming register (connection 2) and transmits the trunk class mark indication to it. The operator then keys the number after receiving a start dialing signal.

4.122 The incoming register seizes a marker through an incoming register marker connector (connection 3) and transmits the above information to it. From the trunk class mark, the marker learns that this is a pulse conversion job and determines whether a dial or revertive pulse outgoing sender is required. It then seizes the proper sender through an outgoing sender connector and transmits the called numericals to it (connection 4). The outgoing sender is connected to the trunk through a sender link (connec-

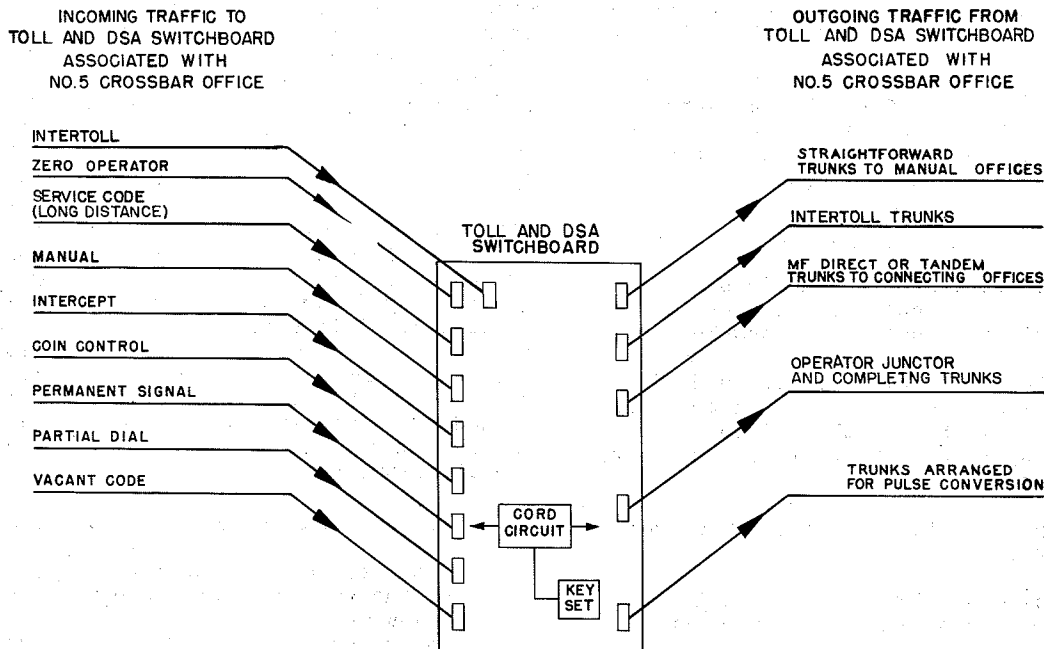

Fig. 46 - Traffic at a Combined Toll and DSA Switchboard Associated With a No. 5 Crossbar Office

tion 5), and after making trunk test, out-pulses the digits to the connecting office. The talking connection is established over the trunk (connection 6). The crossbar control equipment is released and the operator supervises the call.

#### E. Operation of No. 5 Crossbar Office With DSB Switchboard

##### General

4.123 A No. 5 crossbar office which receives calls from manual switchboards not equipped with keysets or dials must have a DSB switchboard associated with it. The operating method in such a case is known as straightforward trunking. An incoming trunk from such a manual office is connected to a central B incoming register in the No. 5 crossbar office through an incoming register link. The central B incoming register is permanently connected to a B switchboard sender which is located at the central DSB switchboard office.

##### Operation With DSB Switchboard

4.124 When a subscriber, who is served by a manual office not equipped with keysets or dials, originates a call to a subscri-

ber served by a No. 5 crossbar office, the called subscriber directory number is given to the operator in the usual manner. The manual operator plugs into an outgoing straightforward trunk which terminates in the called No. 5 crossbar office. (See Fig. 49, attached, connection 1.) This trunk is connected via an incoming register link to a central B incoming register (connection 2) which immediately, without waiting to receive any pulses, signals its associated central B switchboard sender to obtain an idle B position (connections 3 and 4). As soon as an idle B position is selected, order tone is sent to the originating and B operators. This tone warns the B operator to expect the called number and signals the originating operator to transmit it. The called number is transmitted verbally to the B operator who keys it in the sender (connection 5).

4.125 If there is only one office code used by the called No. 5 crossbar office, a double order tone is given to the originating and B operators, indicating that the originating operator should pass only the numerals of the called number and that the B operator should receive and key just the numerals into the central B switchboard sender. If the called No. 5 crossbar office uses more than one office code, a single order

tone is sent to the originating and B operators, indicating that both the office code and the numerals of the called number should be passed by the originating operator, and that the B operator should receive and key both the office code and the numerals into the central B switchboard sender.

4.126 After the number is keyed, the sender transmits it to the register and releases itself from the connection (connection 6). The central B incoming register then connects to a marker and transfers to it the information concerning the called number, the trunk link frame number, and the class mark of the incoming trunk (connection 7).

4.127 The marker proceeds to establish a connection between the incoming trunk and the called subscriber (connections 8, 9, and 10). When the talking connection is established, the marker releases the incoming register and itself; the incoming trunk remains in control of the call (connection 11).

#### F. No. 5 Crossbar Office With Tandem Switching Features

##### General

4.128 Since it is not economical to have direct trunks between all central offices, intermediate switching points are provided to handle traffic between offices that have no direct connections. This type of operation is known as tandem switching.

4.129 A No. 5 crossbar office can be used to provide this tandem switching service in addition to its regular functions. An incoming trunk arranged for handling tandem traffic at a No. 5 crossbar office with tandem switching features can also handle traffic for completion to this office since it is generally economical to combine these two types of traffic over the same trunk group. To permit this dual use, it is necessary to provide such trunks with both trunk link and line link frame locations in the No. 5 office with tandem switching features. The trunk link frame location is used when a call coming in on a tandem trunk terminates in the No. 5 crossbar office. When the incoming call is to be switched to a connecting office through the No. 5 crossbar office, the line link frame location is used.

##### Establishing a Tandem Connection to a Connecting Office Through a No. 5 Crossbar Office

4.130 In Fig. 50, attached, a calling subscriber served by an office, which we shall call X, originates a call to a subscriber served by dial office Z. In this case, there are no direct trunks connecting offices X and Z, and the call is, therefore, routed from office X over a tandem trunk to a No. 5 crossbar office Y, which has completing trunks to office Z. These completing trunks can be used for handling calls from several offices.

4.131 In a No. 5 crossbar office, a tandem trunk incoming from another office is connected to an incoming register through an incoming register link (connection 1). The following information is then transferred to the incoming register: the called directory number; the trunk link frame number (not used on tandem calls); and the trunk number and class mark of the incoming tandem trunk. The trunk number is an arbitrary 3-digit number (000 to 999) assigned to each trunk for the purpose of obtaining the line link equipment location of the trunk. These trunk numbers appear either in a separate trunk number group frame or in a subscriber number group frame. The requirements of each individual office determine which of these two arrangements is used. If there are too many trunk numbers to be handled by the subscriber number group, a separate trunk number group frame is provided. (The called number may consist of five, six, seven, or eight digits: a one-digit office code and four numerals or a one-digit directing code and four numerals; a 2-digit office code and four numerals; a 3-digit office code and four numerals; or a 3-digit office code with four numerals and a party letter.) If the pulses are transmitted on a revertive pulse basis, the office code is designated by "office brush and office group" pulses. These pulses are always sent and are translated by the incoming register into a 2- or 3-digit office code as required for presentation to the marker. The register also determines from its translator the number of selections it may expect and whether the code received is a working or vacant code. The offices reached on a revertive tandem basis are limited to forty. This register will handle calls terminating in the local office as well as those terminating in a distant office.

4.132 The incoming register seizes a marker through an incoming register marker connector and transmits the above information to it (connection 2). From the called office code, the marker determines that a tandem job is necessary because the call is to be switched through to a connecting office. It seizes an outgoing sender through an outgoing sender connector (connection 3), proceeds to engage an outgoing trunk on an idle trunk link frame (connection 4), and connects the outgoing sender and the outgoing trunk by means of the sender link. At the same time, from the trunk number, the marker seizes the proper number group frame through a number group connector and obtains the line link frame location of the tandem trunk (connection 5). The marker then seizes the line link frame on which the incoming tandem trunk appears via a line link connector (connection 6).

4.133 A channel is established between the incoming tandem trunk and the outgoing trunk by the marker (connection 7). The marker then releases the incoming register and itself from the connection and the incoming tandem trunk is left in control of the supervision of the call.

4.134 A feature known as tandem screening is available to permit denial of service from specific incoming trunk groups to selected office codes available to other customers. With this feature, customers in noncommon control offices (such as step-by-step) can be given unlimited access to the No. 5 crossbar office; and they can be denied service by the No. 5 crossbar office to those office codes not allowed on a free basis by their tariff. The incoming trunks used for this purpose are given tandem class-of-service treatment.

Establishing a Terminating Connection in a No. 5 Crossbar Office (Via an Incoming Tandem Trunk)

4.135 A call coming over an incoming tandem trunk and terminating in the No. 5 crossbar office is treated in the same manner as a call coming in on a nontandem trunk.

4.136 In Fig. 50, attached, the incoming tandem trunk connects to an incoming register through an incoming register link (connection 1) and transmits the called number and the trunk link frame number to the register. (This called number only ranges from five to seven digits because there are no party letters in a No. 5 crossbar office.)

4.137 The register seizes a marker by means of an incoming register marker connector and transmits the above information to it (connection 2). The marker seizes the trunk link frame (connection 4) and the number group (connection 5). From the number group, the marker gets the line link location of the called number and seizes the proper line link frame (connection 6). The marker establishes a channel between the incoming tandem trunk and the called line (connection 7). The marker then sets the proper ringing in the ringing selection switch, releases its associated linkage and itself, and leaves the incoming tandem trunk in control of the call.

4.138 A screening feature is also provided on dial pulse incoming nontandem trunks whereby either six or seven digits can be received. This feature is useful when it is not desired to absorb the excess digits in the originating office (such as step-by-step). Under this condition, the marker is handed the incoming class mark, indicating that this particular trunk is incapable of being used in tandem connections, and a signal indicating the proper 6- or 7-digit translator to be used. Then if the marker receives a code not usable over this trunk, it sets up reorder. This feature is applicable regardless of whether or not other trunks in the office or even in the same register link are equipped for tandem operation. The registers must be equipped to record the total number of digits.

#### G. No. 5 Crossbar Office With Toll Center Switching Features

##### General

4.139 A local No. 5 crossbar office may be arranged to serve as a toll center for surrounding offices. This type of office handles the following kinds of traffic:

- (a) Its regular local traffic.
- (b) Toll calls which are originated by its own local subscribers or which terminate to its own local subscribers.
- (c) Toll calls which are switched through the No. 5 crossbar office. (Calls which originate or terminate in near-by tributary or other offices.)
- (d) TX calls to TX operators on the toll switchboard serving the No. 5 crossbar office.

4.140 Traffic between toll offices is carried over intertoll trunks. As mentioned under "Trunks" of Part 3, there are three general types of these trunks; one-way outgoing, one-way incoming, and two way. These trunks have the following frame locations in a No. 5 crossbar office:

- (a) One-way outgoing trunk - only one trunk link frame location.
- (b) One-way incoming trunk - two line link frame locations and one trunk link frame location. The line link frame locations are used on switched through calls. The trunk link frame location is used on incoming calls terminating in the No. 5 office.
- (c) Two-way trunk - two line link frame locations and one trunk link frame location. The line link frame locations are used on switched through calls. The trunk link frame location is used for calls outgoing from the No. 5 office or for incoming calls terminating in the No. 5 office.

4.141 The two line link frame locations for trunks (b) and (c) are provided in order to increase the number of channels between the intertoll trunks and the trunks to connecting offices and thus reduce the number of reorders. In addition to the frame locations listed above, the one-way outgoing and the 2-way intertoll trunks usually have outgoing locations in an intramural toll switchboard.

Establishing a Connection for a Toll Call to a Connecting Office Through a No. 5 Crossbar Office

4.142 As shown in Fig. 51, attached, a calling subscriber served by local office X originates a toll call to a subscriber served by office Z. The calling subscriber is

connected over a long distance (zero or 211) trunk to an outward toll operator serving office X. The toll operator receives the request of the subscriber and plugs into an intertoll trunk connecting to the No. 5 crossbar office Y which has toll center switching features and is in route to the called office.

4.143 After an intertoll trunk terminating in a No. 5 crossbar office is connected to an incoming register by means of an incoming register link (connection 1), a start pulsing signal is returned to the originating operator. The operator then keys the called number into the incoming register. When the trunk number (000 to 999) and class mark, and the called directory number are transmitted to the incoming register, a marker is seized through the incoming register marker connector and this information is passed to it (connection 2). The marker connects to an outgoing sender via the proper connector and transmits the called directory number to it (connection 3). An idle trunk link frame with a trunk to the connecting office is then seized by the marker (connection 4). (If the called office is outside the toll center area served by the No. 5 crossbar office, an intertoll trunk is used to connect to the toll center in which the called office is located.)

4.144 From the trunk number, the marker connects to one of the proper number group frames, and obtains there the location of one of the two line link locations of the trunk (connection 5). (The trunk numbers appear in two number group frames which may be either in parts of the subscriber number groups or in separate trunk number groups. The requirements of an individual office determine which arrangement is used.)

4.145 The marker then seizes the line link frame on which the incoming intertoll trunk appears and proceeds to set up a channel between this trunk and the outgoing trunk (connections 6 and 7). As soon as its functions are completed, the marker releases. The outgoing sender transmits the called number to the connecting office and releases itself and the sender link, leaving the incoming intertoll trunk in control of the call. The talking connection between the calling and called subscribers is established from office X over an intertoll trunk switched through office Y and an outgoing trunk to office Z.

4.146 If the marker cannot find an idle channel on its first attempt, it releases the line link and trunk link frames and seizes the other number group frame. Here it obtains the other line link location of the intertoll trunk and proceeds to establish a channel as before. If the second attempt is unsuccessful, the marker sets the incoming intertoll trunk to return a reorder signal to the originating operator. The reorder condition is set up through the trunk link frame location of the incoming intertoll trunk.

4.147 Calls to TX operators are established in a similar manner. In Fig. 51, the TX operator is shown as one of the terminating points. The outward toll switchboard operator keys or dials the appropriate TX code. The No. 5 office does not output any digits in this case.

#### Establishing a Connection for a Toll Call Terminating in a No. 5 Crossbar Office

4.148 In Fig. 51, attached, a calling subscriber served by local office X originates a toll call to a subscriber served by No. 5 crossbar office Y. This call arrives at office Y on an incoming intertoll trunk in the same manner as the above call. This trunk is connected to an incoming register through an incoming register link (connection 1). The called number and the number of the trunk link frame on which the intertoll trunk appears are registered in the incoming register. The register seizes a marker by means of an incoming register marker connector and transmits this information to it (connection 2). The marker seizes the proper trunk link frame (connection 4) and the number group frame (connection 5).

4.149 From the number group, the marker obtains the line equipment location of the called number and connects to the line link frame on which it appears (connection 6). The marker then establishes a channel between the intertoll trunk and the called subscriber. After setting the proper ringing in the ringing selection switch, the marker releases its associated linkage and itself and leaves the incoming intertoll trunk in control of the call.

4.150 If the marker cannot find an idle channel between the trunk link frame and the line link frame, it sets the incoming intertoll trunk to return a reorder signal to the originating operator.

#### H. Multioffice Operation

4.151 A No. 5 crossbar marker group can handle a maximum of 20,000 directory numbers. A minimum of two office codes must be assigned when the office is equipped with more than 10,000 directory numbers. The number groups may be subdivided in any manner desired in blocks of 1000 between the two office codes, except that one office code cannot be assigned to more than 10,000 directory numbers. These two divisions are called office A and office B.

#### I. Physical-Theoretical Office Operation

4.152 Office A (maximum 10,000 numbers) and office B (maximum 10,000 numbers) can each be subdivided into three arbitrary groups of numbers called physical, theoretical, and extra theoretical, and each of these subdivisions will be assigned a distinct office name.

4.153 The major reasons for using additional offices in a marker group are:

- (a) To obtain discrimination between the number subdivisions for rate purposes.
- (b) To minimize subscriber number changes at the time of the initial installation or at some future time because of foreseeable central office rearrangements. (See 4.158 and 4.159.)

4.154 Whenever the subscribers served by one marker group are located in more than one political subdivision, with different tariffs, assignment of a distinct office code to the subscribers in each such subdivision enables the equipment to provide distinctive charging and routing treatments. In this situation, incoming calls from distant wire centers are given a different charge treatment to the several office codes in the marker group. This discrimination feature prevents completion of calls on which distant subscribers dial the office code of the lowest charge in the No. 5 marker group, followed by the numerals of the office code desired. When such a dialing condition occurs, the calling subscriber is given a routing to an intercepting operator or a machine announcement.

4.155 When discrimination is used, the subscriber numbers associated with the physical, theoretical, and extra theoretical office codes are assigned in increments of 100 numbers and in any ratio desired. The hundreds blocks assigned to any one of these subdivisions need not be consecutive. There is one restriction namely, that an increment of 100 numbers cannot contain numbers of two or more subdivisions.

4.156 When discrimination is not used, any of the hundreds blocks may be arranged to complete the connection when the numerals are preceded by any one of the several office codes in the group of 10,000 numbers.

4.157 Usually where discrimination is used, one or more blocks of 100 numbers are arranged for nondiscrimination. These are called common numbers and are assigned to official lines, business office lines, test lines, etc.

4.158 Where one No. 5 crossbar marker group installation replaces more than one central office, the names associated with these replaced offices may be retained to eliminate wholesale number changes. The No. 5 crossbar equipment cannot, however, inherit directory numbers with party letters.

4.159 Additional office names may be used in anticipation of future growth. The subscribers who are ultimately to be served by new equipment are initially assigned a theoretical office code in the existing marker group. At the time when the new equipment is ready

for use, the subscribers with the theoretical office code are transferred to the new equipment without a number change.

## J. Intermarker Group Operation

### General

4.160 Intermarker group operation is an efficient method of handling the traffic between two No. 5 crossbar marker groups located in the same building. The three types of intermarker group trunks for carrying this traffic are:

- (a) Subscriber to subscriber.
- (b) Subscriber to trunk.
- (c) Trunk to subscriber.

4.161 All these trunks have locations in both marker groups. Types (a) and (c) have trunk link frame locations in each marker group. Type (b) has a trunk link frame location in the nontandem marker group and both line link and trunk link frame locations in the tandem marker group. This method is more efficient and economical than handling such traffic as regular interoffice traffic because the traffic between these marker groups is carried over intermarker group trunks and senders (using subscriber-to-subscriber trunks). This avoids using the conventional outgoing senders, incoming registers, and interoffice trunks.

4.162 The intermarker group sender serves both as an outgoing sender and as incoming register. It acts as an outgoing sender when it is connected to a calling marker and as an incoming register when it is connected to a called marker.

### Method of Operation

4.163 The traffic between the two marker groups is of three types.

#### Type (1) - Subscriber to Subscriber

4.164 For calls that originate in marker group 0 and terminate in marker group 1 and vice versa, the trunks used are called subscriber to subscriber. These calls are routed over an intermarker group trunk which requires the use of an intermarker group sender. From the called code, the marker in the originating office determines that an intermarker group connection is necessary and proceeds to set up a connection to an intermarker group trunk. (See Fig. 52, attached, connections 1 and 2.) The marker also connects to an intermarker group sender and transmits the called directory number to it (connection 3). The calling marker interconnects the trunk and sender via a sender link (connection 4) and releases.

4.165 Now the intermarker group sender acts as an incoming register and connects to a marker in the called office via an incoming register marker connector (connection 5). The sender transmits the called number and the trunk link frame number in marker group 1 to the marker and releases. The marker, from this information, proceeds to set up a regular incoming call connection to the called subscriber (connections 6, 7, 8, and 9).

Type (2) - Subscriber to Trunk

4.166 For calls that originate in marker group 0 and require the use of marker group 1 as a tandem office to a connecting office, the trunks used are called subscriber to trunk. When no direct trunks are provided from marker group 0 to the desired destination or when the direct trunks are all busy and an alternate route is to be used, a call from marker group 0 to a connecting office is tandemed through marker group 1 in order to obtain an outgoing trunk.

4.167 Fig. 53, attached, shows a call to a connecting office from a subscriber in marker group 0. After the marker gets the called number, it recognizes that the required trunk is a subscriber to trunk. This trunk has trunk link and line link frame locations in marker group 1. The marker sets up a connection to the proper trunk (connections 1, 2, and 4), seizes an intermarker group sender (connection 3), and connects them to each other through a sender link. The marker transmits the called number to the sender and releases.

4.168 Since the line link location of this trunk in marker group 1 is going to be used on the call, the trunk number (000 to 999) is obtained from various sources and is registered in the sender link. The sender link then transmits this number to the called marker through the incoming register marker connector (connection 5). The trunk also transmits its trunk link frame number to the sender which in turn transmits it to the called marker (connection 6).

4.169 The marker goes to the number group, and from the trunk number, obtains the line link frame location of the trunk (connection 7). The marker then seizes the line link frame on which the trunk appears (connection 8), and also seizes an idle trunk link frame which has an outgoing trunk (connection 9), and sets up a channel between them (connection 11). At the same time, the marker selects an outgoing sender (connection 10). The marker transmits the called number to the sender, connects the sender and the outgoing trunk through the sender link, and releases. The call proceeds like a regular outgoing call.

4.170 If the marker cannot obtain an idle outgoing trunk, it seizes the trunk link frame location of the intermarker group

trunk (from the trunk link frame number) and sets it to return overflow signal to the calling office.

Type (3) - Trunk to Subscriber

4.171 For calls that originate in connecting offices and require the use of marker group 1 as a tandem or toll center switching point for reaching subscribers in marker group 0, the trunks used in this case are called trunk to subscriber. When incoming traffic is terminated at marker group 1, calls from connecting offices for subscribers in marker group 0 have to be tandemed through an intermarker group basis. The incoming trunks which are regular incoming tandem equipments have two locations in marker group 1; one on the line link frame and one on the trunk link frame. Just as for regular tandem calls, the line link location is used for calls going through the office and the trunk link location for calls terminating in the office.

4.172 As shown in Fig. 54, attached, the call starts out like a regular incoming call, going through the incoming register link and the incoming register to the marker (connection 1). Through this linkage, the following information is transmitted to the marker: the called directory number, the trunk number (000 to 999), and the number of the trunk link frame on which the trunk appears.

4.173 From the called office code, the marker recognizes that this call is to be tandemed through to marker group 0. First, the marker seizes an intermarker group sender (connection 2) and a trunk link frame (connection 3) with an idle intermarker group trunk (trunk to subscriber) and interconnects them through a sender link (connection 4). The marker transmits the called directory number and the trunk link frame number to the sender. Then the marker goes to the number group (connection 5), and by means of the trunk number, obtains the line link frame location of the incoming trunk. The marker seizes this location (connection 6), establishes a channel between the incoming trunk and the intermarker group trunk (connection 7), and releases.

4.174 The intermarker group sender seizes a marker in marker group 0 via a connector, transmits the called number and trunk link frame number to it (connection 8), and releases. The marker seizes the trunk link frame on which the trunk appears (connection 9). The marker then goes to the number group (connection 10), and from the called number, gets the line link location of the called line. After it seizes this location, the marker sets up a channel between the intermarker group trunk and the called subscriber (connection 12). The call proceeds from the incoming trunk through the intermarker group trunk to the called subscriber.

K. Direct and Alternate Route Arrangements in the No. 5 Crossbar SystemDirect Routes

4.175 In a small- or moderate-sized exchange area, generally each local central office has direct trunks to all other central offices in that area. The trunks are usually provided on a one-way basis; that is, traffic in each direction is handled over a separate group of trunks. Such an arrangement permits the interconnection of any two subscribers in the exchange area.

4.176 When the marker is setting up an interoffice call, it determines whether a trunk link frame has idle trunks before seizing the frame. After a frame has been seized, the marker can test a maximum of twenty trunks at one time on the one frame. Since each frame is, therefore, limited to a maximum of twenty trunks per route, the total number of trunks per route in the marker group is limited to twenty times the number of trunk link frames. For example, if office X has five trunk link frames, the marker can determine if any of 100 trunks to office Y are idle by the single trunk link frame test.

4.177 In the above example, if the 100 trunks of office X (five trunk link frames) are not adequate to handle the amount of traffic to office Y, then more than 100 (but not more than 200) trunks are provided. The trunks are divided into two subgroups, 100 trunks maximum per subgroup. These subgroups are spread over the five trunk link frames, a maximum of twenty trunks of each subgroup on a frame.

4.178 Note that the subgroup in such an office cannot have more than 100 trunks because the marker is limited to testing twenty trunks after the frame has been seized. To use both subgroups effectively, the marker allots calls into each subgroup. This is done by testing one subgroup on one call to office Y and the other subgroup on an alternate call. If the marker tests for idle frames with idle trunks in one subgroup but finds no trunks available, it tests the second subgroup in an effort to complete the call successfully before routing it to overflow.

Alternate Routes

4.179 The alternate route principle is a combination of direct and tandem routing. Direct trunk groups are supplied from office X to office Y, but these groups are intentionally made inadequate to carry all of the traffic during heavy loads. Office X will always attempt to route calls over the direct group to office Y first, and, therefore, the high load on that group keeps it working efficiently. When all of the trunks of the direct group are in use and another call is originated to the same destination, the marker in office X will attempt to complete the call over the direct group,

but in this case will find all the trunks busy. The marker then attempts to complete the call over the alternate (tandem) route in the manner of a tandem call.

4.180 In large exchange areas where trunking becomes more involved, more than one alternate route may be available for a call; for example, office X can reach office Y over the direct route trunks, and also through tandem offices 1 and 2.

4.181 The markers in office X route calls for office Y over the direct route trunks as long as any of them are idle. Additional calls are then routed to office Y through tandem office 1. The route through tandem office 1 is called the first alternate route. If both direct route and first alternate route trunks test all busy, the markers in office X attempt to route additional calls for office Y through a tandem office 2 (second alternate route).

4.182 The No. 5 crossbar system can handle three alternate routes, in addition to the direct route. If a call cannot be completed over any of these routes, overflow tone is returned to the calling subscriber.

L. Operator Junctor Operation

4.183 Operator junctors are trunks that are located at the toll and DSA switchboard and on a line link frame and trunk link frame in a No. 5 office. (The trunk link location is used only for setting overflow signal.) DSA or toll operators use them to gain access to the outgoing trunks in the office, and thus switch a call through to a connecting office. Since the operator junctor is a type of tandem trunk, a No. 5 office must be equipped for tandem operation in order to use it.

4.184 In Fig. 55, attached, a calling subscriber reaches a DSA operator and gives her the called number. From this number, the operator determines the route for the call and plugs into an operator junctor. She then keys the called directory number into the trunk (connection 1) which is first connected to an MF incoming register through an incoming register link (connection 2). After the called number, the trunk number, and the trunk link location of the operator junctor are set in the incoming register, the register seizes a marker via an incoming register marker connector and transmits this information to it (connection 3). Directed by the trunk number, the marker goes to the number group and obtains the line link frame location of the trunk (connection 4).

4.185 The marker then seizes an outgoing sender through an outgoing sender connector (connection 5) and transmits the called number to it. By means of a trunk link connector, the marker seizes an idle trunk link frame and an outgoing trunk on that frame (connection 6), and connects the outgoing sender and the outgoing trunk through the sender



link. Through a line link connector, the marker seizes the line link frame on which the operator junctor appears (connection 7). At this point, the marker sets up a channel between the operator junctor and the outgoing trunk. The sender transmits the required digits to the connecting office through the sender link and the outgoing trunk and then releases itself and the sender link. The marker releases upon completion of its functions, and the DSA operator has supervision of the call (connection 8).

#### M. Coin Junctor Operation

4.186 The coin junctor is a unit of equipment used for handling outgoing interoffice and subscriber-to-trunk intermarker group coin traffic. The plan is called coin junctor operation. Coin junctors can be used as alternate routes for groups of regular outgoing coin trunks. With this arrangement, outgoing trunks that handle coin and noncoin traffic do not need coin features.

4.187 On a call using the coin junctor arrangement the subscriber is connected to an outgoing trunk just as on a regular outgoing call. (See Fig. 56, attached, connections 1 to 5.) The marker instructs the outsender to output the called directory number and releases. Now the call proceeds like an incoming tandem call. The called number and the trunk number are placed in the incoming register (connection 6). The register seizes a marker through a connector and transmits this information to it (connection 7). The marker seizes the number group (connection 8) and (from the trunk number) obtains the line link location of the tandem trunk. The marker then proceeds to establish a connection between this location and an outgoing trunk (connections 9, 10, 11, and 12). This outgoing trunk does not have any coin features but must have a tandem completing feature in order to return reverse battery supervision.

4.188 Two trunk circuits have been combined into one circuit which has both outgoing coin and incoming tandem features to make a coin junctor.

#### N. AMA Junctor Operation

##### General

4.189 AMA junctor operation is similar to the coin junctor operation and can be employed for subscriber calls originating in the No. 5 office and completing via outgoing interoffice trunks and also via outgoing intertoll trunks. The latter type of call will be encountered with foreign area customer dialing (FACD) and may also be encountered on the long haul calls within the home numbering area (HACD).

##### AMA Junctor Operation With Outgoing Interoffice Trunks

4.190 Where trunk groups handle a small percentage of AMA billed calls and the rest are noncharge, the AMA junctor method can be used to permit more economical equipment

arrangements. From the standpoint of equipment arrangements, the AMA junctor is assembled from an AMA outgoing trunk and an incoming tandem trunk.

4.191 On a call using the AMA junctor arrangement, the subscriber is connected to the outgoing AMA trunk in the regular manner. The out trunk and outsender call in the AMA equipment to record the necessary details of the call. The associated incoming tandem trunk then calls for an incoming register and the digits are transferred to it. The call is then routed through the frames the second time (like any other tandem call) to the tandem-type non-AMA out trunk.

4.192 Answering supervision is returned to the AMA trunk when the called subscriber answers and a suitable entry is made on the tape. When the call is terminated another entry is made on the tape and all connections are released.

##### AMA Junctor Operation With Outgoing Intertoll Trunks

4.193 As outgoing intertoll trunks are primarily used by operators, they do not contain AMA arrangements nor provision for supplying talking battery supply. Accordingly, when subscribers are given direct access to these trunks with FACD service, the required AMA and talking battery supply arrangements are obtained by associating an auxiliary trunk with the intertoll trunk. Where trunk groups handle a small percentage of subscriber dialed calls compared with operator-handled traffic, it may be more economical to use AMA junctor operation than to furnish the auxiliary trunks. In this case, the equipment arrangements of the AMA junctor are assembled from an AMA outgoing (loop signaling type) trunk and an incoming intertoll (reverse battery signaling type) trunk.

4.194 The method of operation for the AMA junctor for intertoll trunks is similar to that described for interoffice trunks above.

#### O. Selection Preference

##### Selection Preference for Vertical Groups, Horizontal Groups, and Vertical Files

4.195 To assure equal service for all the lines on a line link frame, a circuit arrangement is provided which rotates the order of the marker's preference for serving calling lines one step for each call or connection. The preference chain is fixed but the point of entry is different each time.

4.196 When a marker seizes a line link frame in order to set up a dial tone connection, it follows a fixed selection preference for serving vertical groups, horizontal groups, and vertical files. The only exception to this change of preference is vertical group 02 which is always served first. Police, fire, and other emergency lines appear in

this vertical group. The selection preference feature solves the problem of giving an equal grade of service to all lines when simultaneous demands for dial tone occur. The marker serves one call at a time in accordance with the selection preference sequence and any other call has to wait its turn.

4.197 The sequence of the selection preference of vertical groups on a dial tone job depends on the number of vertical groups on the line link frame. This number may vary from six to twelve depending on how many lines there are on the line link frame.

4.198 When a marker serves a dial tone job on such a line link frame, it immediately looks at vertical group 02. If there is a call on one of the lines in that group, the marker serves it; if not, the marker attempts to serve calls in other vertical groups. The marker proceeds in this manner until it finds a call waiting, for example, on vertical group 03. Then the marker looks at the horizontal groups in vertical group 03 in the sequence 0, 1, 2, 3, 4, 5, 6, 7, 8, 9, and at the vertical files in the sequence 0, 1, 2, 3, 4.

4.199 The entry point on each of these preference sequences is changed with each marker use.

4.200 Because the number of horizontal groups and vertical files in a vertical group is constant, the selection preference sequences for these remain constant.

4.201 On the other hand, the number of vertical groups depends on the capacity of the line link frame; therefore, the selection preference sequences vary according to the number of vertical groups.

#### Selection Preference for Originating Registers and Trunks

4.202 When setting up a dial tone connection, the marker seizes a trunk link frame with at least one idle originating register. If there are several idle registers on the frame, the marker must select one for service. In order to distribute the traffic uniformly over all the originating registers in the office, a method of rotating the selection preference, similar to the one for vertical groups, horizontal groups, and vertical files, is used. Since originating registers associated with a trunk link frame are grouped on a trunk block relay which can serve twenty trunks or registers, a 20-step selection preference sequence is used for selecting the idle register.

4.203 The marker selects the trunk link frames in numerical order, but if idle registers are available on several frames, the first preference advances one frame for each marker use.

4.204 The same method of selection preference applies also to trunks.

#### P. Code Conversion

4.205 When calls outgoing from a No. 5 office are given a trunk routing through an intermediate step-by-step office to several connecting offices, it may be necessary to output, from the No. 5 office to the intermediate office, code digits which do not correspond to the directory code digits received by the No. 5 office marker from a subscriber or an operator. This conversion of codes is required where the trunking arrangements of the step-by-step selectors are on an arbitrary code basis.

4.206 Dial pulse outgoing senders are arranged (optionally) for a maximum of three arbitrary digits from which full flexibility in one-digit, 2-digit, and 3-digit arbitrary codes can be obtained. The arbitrary codes can be substituted for the directory codes (code conversion), or they can be prefixed ahead of directory codes.

#### Q. Calls Involving Equipment Irregularities

##### Stuck Originating Registers

4.207 An originating register may be stuck in such a way that after dialing is completed, it cannot obtain a marker. In this case, the register times out and releases itself and the dialing connection after 19 to 37 seconds. The originating subscriber is then given another dial tone connection. During periods of heavy traffic, the time-out period is reduced to 10 to 18 seconds.

4.208 If the originating register is stuck in such a way that it cannot register any of the dialed digits, the call is treated as a permanent signal.

4.209 If the originating register is stuck in such a way that it registers just some of the dialed digits, the call is treated as a partial dial.

##### Stuck Outgoing Senders

4.210 An outgoing sender, which is being used in an outgoing connection, may not be able to output because of an equipment irregularity. In this case, a DP or RP sender times out after 19 to 37 seconds (a MF sender times out after 13 to 25 seconds), sets the outgoing trunk to give reorder signal to the calling subscriber, and releases itself from the connection.

4.211 If the trunk test which the sender performs fails, the sender goes through the above procedure.

##### Stuck Incoming Registers

4.212 An equipment irregularity may prevent (a) an incoming register from calling in a marker or (b) from transmitting the called number to a marker after the register has

seized one. In the first case, under normal traffic conditions, a DP, RP, or MF register times out after 19 to 37 seconds and the register releases from the incoming trunk. In the second case, the marker having been seized and lacking receipt of the call information, will time for 0.25 to 0.45 or 2.6 to 4.3 seconds, depending upon what information is missing, and then signal the incoming register to make a second attempt. If this attempt fails, the marker signals the incoming register to release, and if conditions permit, signals the incoming trunk to return a reorder signal to the originating end.

4.213 The time-out period for the DP incoming register is reduced to 4.6 to 7.2 seconds during heavy traffic; the time-out period for MF registers remains the same.

4.214 A stuck revertive pulse incoming register does not go to the marker but signals the outgoing sender in the originating office to set up the reorder signal in the trunk. This register has the same time-out periods as the dial pulse register.

#### Marker Irregularities

4.215 If for any reason, while handling a call, a marker encounters a trouble condition, it signals its associated marker connector to select another marker. If the second marker encounters trouble, the above process is repeated. In this way, as long as there is an off-switchhook condition on the calling subscriber line, the line link marker connector continues to select a marker until the subscriber hangs up or the call is completed.

4.216 Before it releases, each marker which encounters trouble calls in the trouble recorder to take a trouble record.

#### Faulty Switchhook Manipulation

4.217 Faulty switchhook manipulation may cause one or more preliminary pulses ("ones") to be transmitted to the originating register before the normal dial pulses. The originating register disregards these preliminary "ones" and does not register anything in the A digit until a digit of two or more pulses is received. (If an office uses an llx code, special provision is made for recognizing the first two digits.)

### 5. EQUIPMENT ARRANGEMENTS

5.01 The locations of the various frames in a typical office are shown in Fig. 57, attached, which is a floor plan of a No. 5 crossbar office initially engineered for forty, 390-line link frames, twenty trunk link frames, and 20,000 subscriber numbers. The floor plan is based on present equipments which use U- and Y-type relays.

5.02 There are certain practices in equipment arrangement which are followed in almost all offices. It can readily be seen in Fig. 57 that the frames are placed in a logical order. The line link and trunk link frame line-ups are usually placed close together to simplify the cabling between these frames and a junctor grouping frame which is common to them. For the same reason, the trunk link connectors are next to each trunk link frame. The testing and maintenance frames are located in a central spot for easy accessibility.

5.03 The basic framework is the same throughout the No. 5 crossbar system: the frames are 11-1/2 feet high, 10-1/2 inches deep, and their width varies from 20-1/2 to 45 inches. Generally, they are arranged with the apparatus sides of two frame line-ups facing each other with a 2-foot, 6-inch aisle between them. The wiring aisle between the backs of the frames are about 23 inches wide.

5.04 Covers are provided for the front of certain frames to exclude dust from the apparatus. There are metal covers for some equipment units and transparent plastic covers for others. When the equipment units are enclosed with front covers, front horizontal baffles are provided to prevent the distribution of dust and the spread of fire. Rear baffles are provided with rear covers.

5.05 An end guard, which is a metal panel, is placed on the side of the frame at the end of a frame line-up. The aisle pilot lamps for the alarm systems are mounted on these end guards at the main aisle end of the line-up. There is also space for mounting the frame distributing fuses at the top of the end guard panel.

5.06 The front of each frame is stamped with its name and number. (The frame designations are listed in Fig. 57.) In addition, each line-up has designation cards to identify each frame and its position in the line-up.

5.07 In order to trace the interconnections between the circuits mounted on these frames, designation cards which contain this information are provided for various frames.

### 6. MAINTENANCE FEATURES

#### A. General

6.01 The basic provisions for maintenance of No. 5 crossbar system offices consist of testing equipment for the various circuits and associated apparatus, arrangements for providing notice of and information about failures occurring on service, and test calls and means for removing equipment from service. In addition, testing equipment is provided for use in the maintenance of the subscriber line plant and of trunks terminating in other buildings.

6.02 The majority of the equipment required for the maintenance features is mounted on bays which collectively are called the "master test frame." The remaining apparatus is mounted on other equipment bays or frames or in portable test boxes.

6.03 The master test frame bays, shown in Fig. 58, are required in every office. They are located in the maintenance center since most of the apparatus required for operating and administering the testing and other maintenance features associated with the master test frame is mounted thereon. This apparatus includes a recording device which automatically provides information in the form of punched cards concerning failures on service calls and also regarding the results of certain test calls. Views of an unpunched card and a punched card are shown in Fig. 61, attached.

6.04 A basic 2-bay frame is provided as part of the master test frame in every office for the purpose of connecting to as many as six completing or combined markers. An auxiliary bay is provided for each three additional markers. A separate connector bay is provided for connecting to dial tone markers. These connector bays shown in Fig. 60, attached, will be placed in some convenient location but not necessarily in or close to the maintenance center.

6.05 From one to four additional frames may be required depending on the type of testing equipment desired for the senders and registers and upon the types of senders and registers to be tested. These bays which will also be located in some convenient location on the maintenance center floor are shown in Fig. 59, attached.

6.06 The following choice of testing equipment for the senders and registers is available:

- (a) Arrangements providing extensive tests of the circuits including the use of permanently located apparatus for automatically producing digits or selections using pulses which are precise as to speed or ratio of open to closed intervals and also including registering devices for receiving the output of senders.
- (b) Simple testing equipment employing portable test sets which impose marginal tests only where a small expense in apparatus is required and which, in general use, requires that digit and selection pulses be produced by manually operating a dial or keys. Some auxiliary apparatus is required and is located on the master test frame. With such an arrangement, a pulse generator capable of producing pulses which are accurate as to speed and length of pulse and which can be varied over a considerable range will be required for occasional conditioning purposes. Such a generator is available in portable form.

6.07 The choice of testing arrangements can be made for each type of sender or incoming register, except for tandem revertive incoming registers. For these registers only the simple type of testing equipment is available.

6.08 The more complete type of testing equipment is a dual purpose arrangement which permits its use as a means for automatically monitoring on the senders and registers while they are being used on service calls. Failures indicated during this monitoring process causes the trouble recorder to make a record of the conditions and of the circuit units used on the call.

6.09 In addition to the trouble recorder mentioned previously, the following apparatus is mounted on the four basic bays located at the maintenance center.

- (a) Keys, lamps, and other apparatus for directing test calls to the circuit or combination of circuits to be tested, for controlling the actual testing functions and denoting the progress of the test call, and for controlling arrangements for monitoring on senders and registers. Certain testing functions are also included in the control circuit.
- (b) The apparatus required for making tests of trunk circuits.
- (c) Lamps for indicating certain trouble conditions which do not cause an automatic record to be made and other lamps which indicate the duration of use of certain of the circuits.
- (d) Lamps and jacks associated with permanent signal holding trunks, common overflow trunks, and plugging-up lines.
- (e) Jacks for taking out of service units of the common control equipment.
- (f) Test and make-busy jacks for outgoing trunks.
- (g) A voltmeter circuit for use in testing subscriber lines and outgoing trunk circuits.
- (h) Communication trunks including a telephone circuit and a dial.
- (i) Plant peg count registers.

6.10 Some of the other testing equipments used in No. 5 crossbar offices are as follows:

- (a) A manually operated outgoing trunk test frame for use where the number of outgoing trunks is large.
- (b) A No. 18B toll test board for use in maintaining intertoll trunks.

- (c) Test lines for use in making tests of the operating and signaling features of local and intertoll trunk circuits.
- (d) Test lines for making 1000-cycle one-way transmission tests of local and intertoll trunks.
- (e) A test line for making a balance test of intertoll trunk circuits.
- (f) Means for applying 100 operation tests to subscriber message registers.
- (g) A test circuit for checking foreign area translator code cross connections.
- (h) Several portable test sets.
- (i) Testing arrangements required for use in the maintenance of the subscriber lines consisting of:
  - (1) An automatic line insulation test circuit.
  - (2) Station ringer test arrangements.
  - (3) Trunks to the local test desk.
  - (4) "Test" and "no test" trunks by way of which the subscriber lines can be reached from local test desk positions.
  - (5) A circuit under control of the test desk for providing access to permanent signal holding trunks and plugging-up lines.

6.11 An alarm system giving audible and visual signals is provided by means of which the central office force is advised of the occurrence of trouble conditions and directed to the proper location. The direction is accomplished by a pilot lamp indicating the floor involved, pilot lamps at main aisles, at cross aisles, and at the aisle to which the attention should be directed. Individual lamps are provided on equipment frames or on the master test frame as needed. Arrangements are available for transferring alarm indications to some other point in the same or another building when the office is to be unattended.

6.12 Except for the simplified testing arrangements, the uses and operation of the various features of the master test frame are described in Section A770.201 and no further description is given herein.

6.13 General description of the simplified testing arrangements, testing equipment for message registers, and arrangements for testing of the subscriber station ringers and of the general central office alarm circuits are given in the following paragraphs.

#### B. Test Set-type Testing Arrangements for Registers and Senders

6.14 A portable test set is provided for use in testing both originating and incoming registers. This test set is provided with two

standard dials, one in the 8 to 11 pulse per second range and one in the 16 to 19 pulse per second range. A keyset is also provided for use in testing MF incoming registers. The dials are used for testing both originating and dial incoming registers. Some additional control keys and lamps are also provided.

6.15 Access to originating registers is obtained by the master test frame in the same manner as when the more complete test equipment is provided. The portable test set is then connected to the registers by way of the master test frame. The dials on the test set are then used to send the test code and number into the register. The results of the test are shown on a trouble recorder card.

6.16 Access to incoming registers is obtained by way of a control circuit provided when the portable set is to be used. This control circuit is mounted on the master test frame. The test set is connected to the control circuit and some other auxiliary apparatus, to a source of multifrequency for use when testing MF registers, and to a source of battery and ground by way of multiconductor patching cord and jack. When testing revertive incoming registers, the keyset is used to control the number of revertive pulses expected for each selection. As for originating registers, the results of tests of incoming registers are shown on a trouble recorder card.

6.17 A separate portable test set is provided for testing outgoing senders and a separate auxiliary relay circuit is also required for each type of outgoing sender; that is, dial, MF, revertive, and PCI. Access to the sender is obtained by way of the master test frame as when the more complete test arrangement is used.

6.18 Test connections are made as described for the registers, although for this test set two multiconductor patching cords are needed.

6.19 The test set is provided with lamps which light as dial, MF, or PCI pulses are transmitted by the sender. In the case of revertive senders, the pulses are transmitted by the auxiliary relay circuit, and the lamps record the number of pulses required to cause the sender to open its fundamental circuit on each selection. In the case of MF senders, the pulses are transmitted by the sender into a MF receiver from which the test set gets its information. This receiver can be the one which is normally associated with a MF incoming register. If such registers are not provided, a receiver must be provided for testing purposes.

6.20 The portable test sets can be used at the master test frame, or by a tie line arrangement, at the location of the circuit being tested.

C. Electronic Pulse Generator

6.21 The electronic pulse generator is a portable device arranged so that pulses (opening and closing of a circuit path) at any desired speed and ratio of closed to open periods over a reasonably large range can be obtained. This generator can be used to transmit dial, MF, or revertive pulses having the desired characteristics. The purpose of this generator is to provide means for making an occasional marginal test of senders and registers without making it necessary to provide pulse generating equipment for the purpose in the master test frame in every office.

D. Testing Equipment for Subscriber Message Registers

6.22 The testing equipment for subscriber message registers is contained in or is associated with a trunk circuit. Access to the message register circuit which is connected to the sleeve lead of the subscriber line circuit is obtained by originating a test call to the subscriber line by way of the trunk circuit.

6.23 In addition to apparatus required for establishing and supervising connection to a subscriber line, the trunk circuit contains a synchronous motor-driven interrupter for applying tests exactly 100 times, switches and other apparatus for adjusting test voltages, a voltmeter and jacks for use in measuring the voltages, and relays for recording indications of whether the number is cross-connected for a tip or ring party or for an intermediate line in a terminal hunting group. A keyset is provided in offices where a MF incoming register is used for the establishment of the test connections.

6.24 Associated with the trunk circuit and having multiple appearances on all message register frames are three jacks, three lamps, and one key. One jack is used for originating test calls and the other jacks for associating test sets for message register testing. The key is used to apply full voltage rather than the operate or nonoperate voltages. The three lamps provide an indication of the number cross connections.

E. Arrangement for Testing Subscriber Station Ringers

6.25 Tests of station ringers are made in somewhat the same manner as in other dial systems; that is, a station ringer test circuit is reached by dialing and then the receiver is replaced after which the ringing current is applied. The ringing is stopped by again taking the receiver off the hook.

6.26 For the No. 5 crossbar system, a special code is dialed followed by the number assigned to the station under test. The code causes a connection to be established between the line and a ringer test circuit.

6.27 The number which is dialed causes the marker to set the ringing selection switch associated with the selected circuit for the kind of ringing which the station should receive.

F. Central Office Alarm System

6.28 The central office alarm system provides audible and visual signals as needed to notify the maintenance force of the occurrence of trouble conditions and of the location of the equipment in trouble.

6.29 Each aisle is equipped with a red aisle pilot lamp for indicating major alarms involving that aisle and a green aisle pilot lamp for indicating minor alarms.

6.30 The same general arrangement of cross aisle, main aisle, and other floor and exit pilots as has been used previously is provided. Similarly, an individual lamp indicating the equipment causing the alarm is provided.

6.31 The audible signals are those which have been standard for other systems namely:

- (a) Tone bar for major alarms.
- (b) Subscriber sets for minor alarms.
- (c) Subscriber set for alarm battery fuse alarms.
- (d) Loud ringing bell for indicating power failures affecting substantial amounts of equipment.

G. Automatic Line Insulation Test Equipment

6.32 The primary function of this equipment is to automatically scan subscriber lines for defects which manifest themselves as low insulation resistance. (See Fig. 62, attached.) A secondary function (optional) is its use for making certain traffic measurements. In regard to the latter, it is arranged to automatically scan line links and trunk links at regular intervals and to record the number of links found busy.

6.33 When used for testing subscriber line insulation, it tests about 12,000 lines per hour and records the line link equipment number of the lines failing to meet the test conditions, on the trouble recorder of the No. 5 office, or transmits the data to a teletypewriter page printer at the local test center.

7. GLOSSARY

A and B Appearances For Trunks on Trunk Link Frame: These are the two possible trunk switching connections on a trunk link frame. Trunks are assigned to these appearances according to the traffic engineering practices of an office. Originating registers are always assigned to the A appearances.

**Alternate Routing:** A method of advancing a call at any point by diverting it to a trunk group, other than the first choice group, when the first choice group is busy. Arrangements for three alternate routes are provided.

**Assistance Call:** A call which the subscriber could or could not dial directly but on which he dials zero to contact the operator for assistance.

**Automatic Message Accounting System or AMA System:** An equipment arrangement for recording and processing on continuous tapes the data required for computing telephone charges on customer dialed calls and calls handled by operators where provision is made for treating these calls in a similar manner. The system may include provision for compiling all charges and credits which affect the customer's bill and the automatic printing of the bill.

**Automatic Monitor:** A unit of equipment which attaches itself to registers and senders on a progressive basis; records without distortion the signaling input and compares this with the output. It calls in the trouble recorder for recording any incorrect operation. It may be used under manual control for testing senders and registers.

**Blank Number:** A number outside the assigned capacity for a particular office.

**Call Versus Job:** The word call is used only if the function is inclusive of all equipment. (See Job.)

**Central Office Code:** A code consisting of the one, two, or three digits or letters which appear in front of the numerals of a directory number. The central office code identifies a particular office within an exchange area.

**Channel:** A combination of a line link, a junctor, and a trunk link which, by crosspoint closures, forms a path to connect a line with a trunk or a trunk with a trunk.

**Channel Number:** A composite number identifying the line switch horizontal number of the line link, the trunk switch vertical number of the trunk link, and the junctor switch number in a channel.

**Charge Delay Interval:** An extended interval of time (2 to 5 seconds), maintained in the control of message charging, to insure against possibilities of errors due to transients or other conditions of short time duration.

**Class of Service:** The commercial term applying to the subgrouping of subscribers for the sake of rate distinctions. This subgrouping may, for example, distinguish between individual and party, between business, residence, and coin, between flat rate and message rate, between restricted and extended scope.

In equipment and traffic engineering, it is used to refer to the subgrouping of lines for originating service for the sake of equipment operation distinction, independently of whether rate distinctions are involved; for example, in dial operation, lines may be subdivided into PBX and non-PBX classes to permit proper use of the howler on permanent signal conditions.

**CLR Operator:** A toll operator who performs the following duties:

- (a) Answers the call when the subscriber dials the 211 long distance code.
- (b) Writes the toll ticket using the information furnished by the subscriber.
- (c) Makes attempts to reach the called party while holding the calling party.
- (d) Times the call if connection is established.
- (e) Passes the ticket to the designated TX operator if the initial attempts fail and she dismisses the subscriber.

**Code Conversion:** Converting a directory or toll directing code into an arbitrary code for controlling the selection of a trunk route at a distant switching point.

**Code Point:** A terminal punching located in a cross-connection field in the marker and energized by registration of a 1-, 2-, or 3-digit code.

**Code Ringing:** Party-line ringing wherein the number of rings, or their duration, or both, indicate which subscriber is being called.

**Coin Service:** A public, semipublic, or subscriber class of service which has a coin-collecting device as part of the station equipment.

**Coin Supervisory Link:** A switching arrangement for connecting originating dial equipment to coin supervisory circuits.

**Coin Test:** A test made by either the originating register or coin supervisory circuit to establish the presence of a coin in the trap of a coin station subset.

**Combined Toll and Dial System A Switchboard or Toll and DSA Switchboard:** A local dial office switchboard which handles toll assistance calls, intercepted calls, and calls from miscellaneous lines and trunks.

**Common Control Equipment:** All switching equipment exclusive of line link frames and trunk link frames.

**Connector:** A relay-type switching device for interconnecting, for a short interval of time, two equipment elements over a relatively large number of leads.

Dial Pulsing or DP: A system of d-c pulsing in which the digits are transmitted by the interruption of the d-c circuit a number of times, one to ten corresponding to the digits one to zero on the dial.

Dial System B Switchboard or DSB Board: A switchboard of a dial system for completing incoming calls received from operators over straightforward or call circuit trunks.

Dial Tone: A tone used in dial telephone systems to indicate that the equipment is ready for the dialing operation.

Directing Code: Digits, such as 11, XOX, and XLX, dialed ahead of the directory number of the called station. These will enable a subscriber or operator to dial a number in an area next to or near the basic numbering plan area of the subscriber or operator.

Directory Number: The full complement of digits required to designate a subscriber in the directory. In a 5-, 6-, or 7-digit exchange area, the directory number consists of the office code followed by four numerals. In some areas a station letter, to control selected ringing, follows the four numerals and is considered part of the number.

Divided Ringing: A method of obtaining partial ringing selectivity by connecting one-half of the ringers from one side of the line to ground and the other half from the other side of the line to ground. This term is not ordinarily applied to selective and semiselective ringing systems.

Exchange: A unit of a telephone company used for the administration of service in a specified area which usually embraces a city, town, or village, and its environs. It consists of one or more central offices together with the associated plant used in furnishing communication service in that area. Ordinarily an individual local tariff is filed for each exchange.

Exchange Area: The territory included within the boundaries of an exchange.

Extheo: Contraction of the words "extra" and "theoretical." (See definition of theoretical number.)

Flat-rate Service: A subscriber classification of local service in connection with which a stipulated monthly charge is made covering all message use to stations within a specified area.

Foreign Area: A numbering plan area other than the numbering plan area in which a calling subscriber is located (see Numbering Plan Area).

Foreign Area Translator: An equipment frame and associated circuits common to a marker group, used in conjunction with the markers

for translating the office codes of a foreign area for routing purposes when there is more than one trunk route available for entry into the foreign area.

Free Code Call: A call which the terminating equipment recognizes from the code dialed as one to be handled on a free service basis.

Home Area: The numbering plan area in which a calling subscriber is located.

Horizontal Group: All of the lines served by the same ten line links.

Incoming Register: The register which receives the pulsing (dial, multifrequency, or revertive) from the incoming trunk and transmits it to the marker through an incoming register marker connector.

Incoming Register Link: A switching arrangement for connecting incoming trunks to incoming registers.

Incoming Trunk: A trunk incoming to a local central office switching unit for use in terminating calls on the subscriber lines of that unit. Also, a trunk incoming to a local toll, tandem, or PBX switchboard or switching unit.

Interoffice Trunk: A trunk between two switching units regardless of type. This term is confined largely to trunks between local offices in the same exchange area.

Intertoll Office Trunk or Intertoll Trunk: A trunk between toll switchboards or toll switching systems in different offices.

Note: Where combined toll and local switchboards are involved, the trunks are classed as intertoll or interlocal, depending upon whether the switchboards in question are performing toll switchboard or local switchboard functions in handling the traffic over these trunks.

Intraoffice Trunk: A trunk between two points in the same central office or switching unit where the unit serves more than one central office.

Intermarker Group Trunk: A trunk between two marker groups located in the same building. There are three types of these trunks:

- (a) Subscriber to subscriber.
- (b) Subscriber to trunk.
- (c) Trunk to subscriber.

Inward and Through Toll Position: An inward and through toll position is used primarily to receive calls over intertoll trunks and to establish inward connections to local subscribers or to extend through connections to other intertoll trunks. In certain cases, the inward function and the through function may be performed at separate positions.

Job: A specific function attributed to the marker. (See Marker Job.)



**Junctor:** A circuit extending between frames of a switching unit and terminating in a switching device on each frame.

**Junctor Group:** The juncctors which extend from a particular line link frame to a trunk link frame. The size of the junctor group depends on the number of trunk link frames or pairs of trunk link frames.

**Junctor Grouping Frame:** A frame which functions to facilitate the distribution of the 100 juncctors from each line link frame to all of the trunk link frames so that each line link frame will have equal access to all trunk link frames.

**Line Link:** A switching arrangement for connecting subscriber lines to juncctors on originating calls and juncctors to subscriber lines or trunks on terminating or through calls.

**Line Link Frame:** A frame containing line links with associated equipment and subscriber line relays.

**Local Central Office or Local Office:** A switching unit in a telephone system serving primarily as a place of termination for subscriber lines. It has a maximum of 10,000 numbers. Services can be provided on both a physical and theoretical office basis. This arrangement is considered as one local central office.

**Local Service Area:** The area within which are located the stations which a subscriber may call at local rates in accordance with the provision of the local tariff.

**Main Distributing Frame or MDF:** A structure for terminating the permanent inside and outside wires in a central office, and for effecting flexible connections between them. It generally carries the central office protective devices and functions as a test point between line and office.

**Marker:** Equipment which establishes communication paths between calling subscribers and trunks, between trunks and called subscribers, and between trunks.

**Marker - Combined:** A marker which performs all marker operations in the office.

**Marker - Completing:** A marker which performs all marker operations except the dial tone stage.

**Marker - Dial Tone:** A marker which performs marker dial tone stage operations only.

**Marker Group:** A common group of markers which serves one or more central offices. A marker group may serve as many as 20,000 numbers. For administrative and statistical purposes where provision is made for serving more than 10,000 directory numbers with common control equipment, each group of 10,000

numbers is considered a separate central office. A central office may serve some subscribers on a theoretical basis with additional office names and codes. Such a theoretical office arrangement is not considered as a separate central office. The terms office A and office B refer to each half of the 20,000 numbers in describing the functions of the switching circuits of the marker group. (The term marker group is also used to refer to the equipment served by a marker group.)

**Marker Job:** The single marker usage (from seizure to release) involved in completing any one of its designated functions.

Marker jobs are accordingly indicated as:

- (a) Dial Tone Job
- (b) Intraoffice Trunk Job
- (c) Outgoing Trunk Job
- (d) Incoming Trunk Job
- (e) Reverting Trunk Job
- (f) Toll Trunk Job
- (g) Tandem Trunk Job

**Master Test Frame:** A unit of equipment which provides for the testing of the equipment units of a marker group.

**Master Test Frame Connector:** A connector by which markers and other equipment obtain access to the master test frame.

**Message Rate Service:** A subscriber classification of local service which is measured in terms of messages or message units for the purpose of charging for the service.

**Message Register:** A counting device which records message units on originating traffic for calls to points within the one message unit charge area. In the No. 5 crossbar system, message registers can be used only in connection with individual and 2-party message rate classes of service.

**Message Unit:** The unit of measurement for charging for message use by the translation into equivalent message units of ticket or AMA charges for calls within a specified area.

**Multifrequency Pulsing or MF:** A method of pulsing in which the identity of the ten digits, zero to nine, and the start and end signals are each determined by various combinations of two each of six frequencies. The two frequencies for each digit or signal are transmitted simultaneously over the trunk.

**No-hunt Call:** A call, made from the outgoing trunk test frame or the message register rack, which will not hunt in a terminal hunting group. If the line associated with the dialed number is busy, busy signal is returned.

**Nondiscriminating Number:** A number associated with two office codes. Such a number is reached regardless of which of the two codes is dialed.

**No-test Call:** A call from an operator or a test desk man which will connect to the dialed subscriber line regardless of whether or not it is busy. If the line is idle, the connection is established through a channel, and if the line is busy, the connection is established through the no-test connector and a no-test vertical on the line link frame.

**No-test File:** The ten vertical units which are used for no-test operation and are located one above another on a line switch bay of the basic line link frame.

**No-test Vertical:** Vertical file 0 in vertical group 2 of each line link frame contains ten no-test verticals. These no-test verticals are used when a connection is established between a busy line and a no-test trunk through the no-test connector. No-test verticals 0 to 4 are multiplied, and also no-test verticals 5 to 9, so that only two no-test calls may be simultaneously established, through the no-test connector, between no-test trunks and busy line of one line link frame.

**Number or Numericals:** The digits which identify a subscriber in a central office. A letter suffix, a requirement in some offices, is considered part of the numericals.

**Number Group:** A group of 1000 consecutive directory numbers, within one numerical thousand, which is treated as a unit by a marker in setting up an intraoffice, incoming, or tandem call.

**Numbering Plan:** The arrangement of digits as listed in local area directories; for example, a directory number with three code digits and four numericals is in a 7-digit numbering plan.

**Numbering Plan Area:** The United States and Canada are divided into a total of 92 numbering plan areas. In general, the subdivisions follow state and province boundaries. However, where there is a high telephone density, a state or province may have two or more areas within its geographical boundary. Each numbering plan area is assigned a national code in the XOX and XLX code series. Within a numbering plan area there can be no office code conflicts.

**Office A - Office B:** The terms which refer to each of the two 10,000 number series in a marker group. (See Marker Group.)

**Office Selector Tandem:** A group of distant office selectors controlled from the originating office or from a sender tandem. (See Panel Tandem Office.)

**Operator - Completing Trunk:** A trunk at the DSA switchboard over which the operator can complete assistance calls both to a subscriber served by the office in the building or to an outgoing trunk from that office.

**Originating Register:** A register connected to a subscriber line via line and trunk links for giving dial tone and for recording the subscriber dialed pulses.

**Originating Stage:** That portion of the switching process involved in extending the connection from the selected intraoffice trunk to the originating line. The originating stage is a subdivision of the marker intraoffice trunk job.

**Outgoing Trunk:** A trunk used for calls terminated outside a switching unit.

**Outward Toll Position:** An outward toll position is arranged to receive primarily toll calls from subscribers, and to complete, time, and ticket such calls. These positions may also handle DSA traffic.

**Overflow Tone:** A tone returned to the calling subscriber to indicate the call could not be completed because the marker was unable to find an idle channel, outgoing sender, or trunk to use in the connection. Overflow tone is usually interrupted 120 times per minute.

**Panel Call Indicator Pulsing or PCI Pulsing:** A system of d-c pulsing in which each digit is transmitted as a series of four marginal and polarized impulses.

**Panel Tandem Office:** Panel tandem offices are of two general types as follows:

- (a) **Sender Tandem:** Tandem and completing office selections are controlled by a sender in the tandem office. This sender gets its setting either from a tandem operator's key (operator tandem) or from another office in the form of pulses (full selector tandem).
- (b) **Office Selector Tandem:** See above.

**Partial Dial or Partial Digits:** A failure of the originating register to receive sufficient digits to complete the call. It may result from a subscriber dialing before dial tone, or failing to dial sufficient digits after receiving dial tone.

**Party Line:** A subscriber line arranged to serve more than one main station. Provision is made for discriminatory ringing with respect to the parties on that line.

**Permanent Signal:** The condition caused by the operation of a line relay followed by no dialing. After a measured interval, the subscriber line is connected to a permanent signal trunk in order to conserve register usage and to insure proper maintenance action in case of trouble on the line.

**Physical Number:** An arbitrary designation for the numbers associated with only one of three office codes, using the same 10,000 number series. The numbers associated with the other office code only are designated as theoretical numbers, or extheo numbers.

**Physical-Theoretical Discriminating Features:** The feature which indicates to the marker whether the physical or the theoretical office is wanted, and whether the number is a physical or a theoretical number.

**Pretranslation:** This operation takes place after a fixed number of digits (usually the office code) have been recorded to determine how many additional digits (if any) are required for the complete translation of the directory number. This feature is designed to reduce time delay in transmitting the call from the register to the marker where the total number of digits of the directory numbers in one office varies.

**Pulse Conversion:** The operation of changing, when necessary, the type of pulsing between connecting offices in order to meet their particular transmission requirements.

**Pulsing:** The act of transmitting digit information over a circuit to a switching unit for the purpose of reaching a called subscriber or operator. The various kinds of pulsing used in the No. 5 crossbar system office with interconnecting offices include:

Dial (DP)  
Multifrequency (MF)  
Panel Call Indicator (PCI)  
Revertive (RP)

**Recycle:** The action which releases the initially selected trunk and permits an attempt to establish the connection to another trunk of the same route but using a different group of junctors and trunk links.

**Reverting Call:** A subscriber-dialed call between two subscribers served by the same subscriber line.

**Revertive Pulsing or RP:** A system of d-c pulsing in which intelligence is transmitted in the following manner:

- (a) The near end presets itself in a condition representing the number of pulses required and in a condition to count the pulses received from the far end.
- (b) The terminating end transmits a series of pulses by momentary grounding out of its battery supply until the originating end breaks the d-c path to indicate that the required number of pulses have been counted.

**Reverting Call Trunk:** A trunk used to set up a talking channel for a reverting call.

**Selective Ringing:** A party-line ringing system where the bell or bells of the desired party only are rung. The No. 5 system is designed to utilize individual 2- and 4-party, full-selective ringing.

**Semiselective Ringing:** A party-line ringing system where the station bells of two parties are rung simultaneously, differentiation being made by a one-ring, 2-ring code. The No. 5 system is designed to utilize 4- and 8-party semiselective ringing.

**Sender:** A unit of equipment in the dial switching system which receives pulses from the marker and transmits these pulses to a distant office.

**Sender Link:** A switching arrangement for connecting outgoing senders and trunks.

**Service Code Call:** A subscriber call to a service desk (such as repair, test desk, long distance) which is identified by the code dialed (usually an X11 code).

**Special Hunt Test Call:** A call made from the test desk to a subscriber line for the purpose of making voltmeter and other tests on the line. Special test calls use a "special" marker, and certain tests which are made on regular calls are omitted.

**Tandem Central Office or Tandem Office:** A central office used primarily as an intermediate switching point for traffic between other central offices. Unless qualified by a prefix or other explanation, this term is restricted by usage to an office used primarily for the interconnection of local central offices.

**Tandem Screening:** A circuit feature of combined and completing markers whereby calls incoming to a No. 5 office, serving as a tandem office, from subscribers in a step-by-step office can be screened for rate purposes. The code of the called office received in the marker must be one within the rate area of the calling subscriber in order for the call to proceed through the tandem office, otherwise, the call is denied completion.

**Tandem Trunk:** A trunk incoming to a tandem office, tandem switchboard, or tandem position from a local office or local switchboard.

**Terminal Hunting:** The function performed by the switching equipment in a dial office in searching for an idle line in a PBX or other terminal hunting group.

**Terminating Stage:** The switching process involved in extending the connection from the selected intraoffice trunk to the terminating line. The terminating stage is a subdivision of the marker intraoffice trunk job.

**Theoretical Number:** An arbitrary designation for the numbers associated with only one of three office codes using the same 10,000 number series. The numbers associated with the other office codes only are designated as physical numbers or extheo numbers.

**Toll Call:** Any call for a destination outside of the local service area of the calling station.

Tone Trunk: A trunk which supplies tone to the calling subscriber. The marker attempts to route a subscriber to a tone trunk for conditions of overflow, partial dial, vacant code, or line busy on an intraoffice call.

Trunk Link: A switching arrangement for connecting originating registers and trunks to junctors.

TX Call: A call which terminates at a TX operator's position.

TX Operator: An outward toll operator or team of operators who performs three specialized jobs:

- (a) Initiates subsequent attempts on toll calls which are delayed because either (1) the called party does not answer, (2) the called line is busy, (3) an "all circuits busy" condition was encountered on the initial attempts by the CLR operator, or (4) the specific person was not available on a person-to-person call. In the last case the CLR operator "leaves word" for the called person to call the TX operator in the originating city.
- (b) Completes the call when the specific person in the distant city reports back on a "leave word" call.

- (c) Keeps a file of uncompleted and delayed toll tickets to specific locations and answers queries concerning the status of completion.

TX Trunk: A trunk that has its terminating end in front of a TX operator.

Unassigned Number: A number within the assigned capacity for a particular office but unassigned to a subscriber.

Vacant Code or Vacant Code Point: A code point which is unassigned. If a call is directed to a vacant code point, it is routed to an operator or vacant code trunk.

Vertical File: The ten vertical units of a crossbar switch located one above another on a line link frame.

Vertical Group: The five vertical files making up the left or right half of a column of lines.

Note: One of the vertical groups of each line link frame contains the no-test file. Consequently this vertical group has only forty instead of fifty lines.

Attached:

Figs. 1, 2, 4 to 6, 8 to 31, 37 to 43,  
and 47 to 62

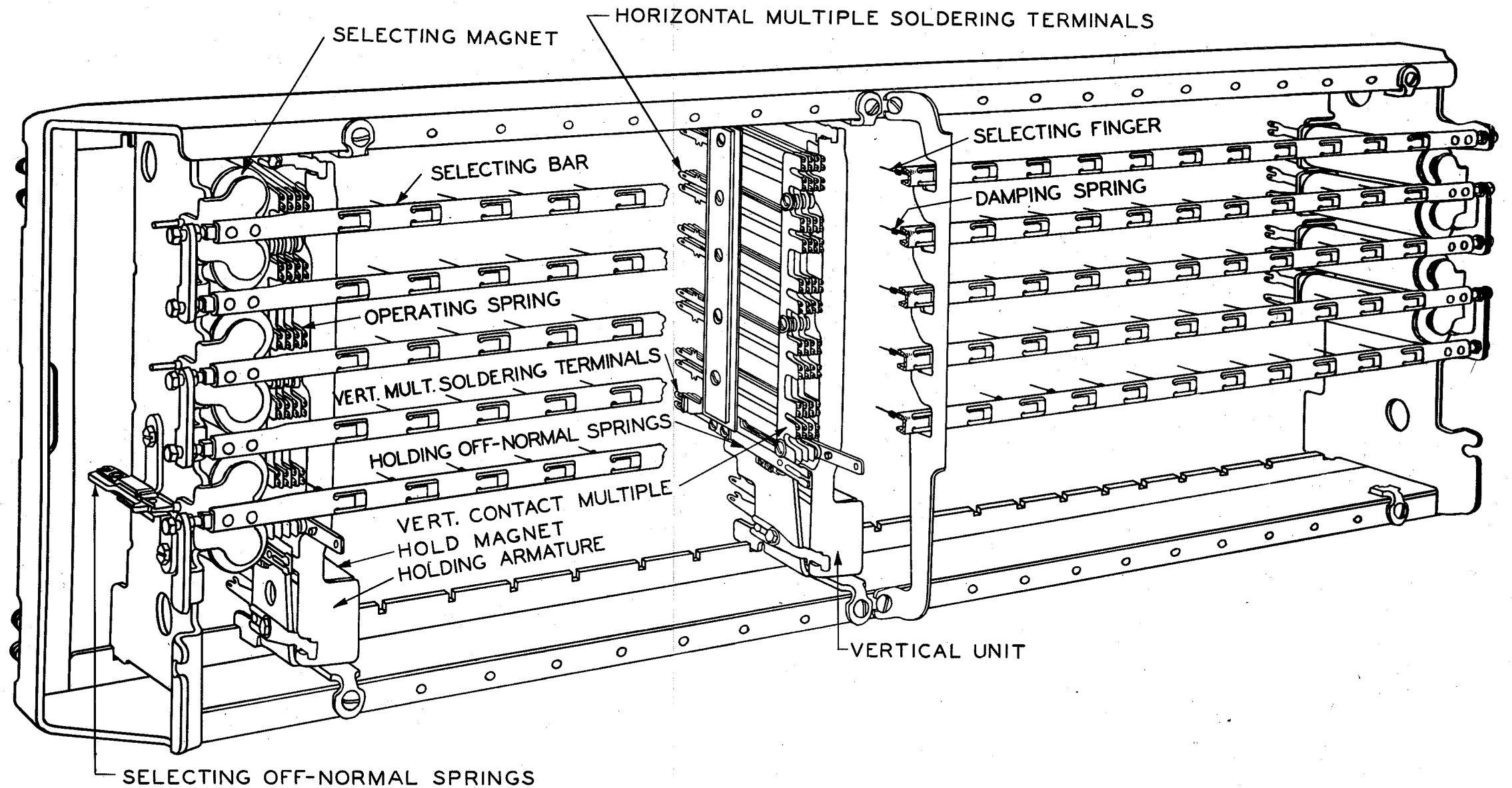

FIG. 1  
PARTIAL PERSPECTIVE VIEW OF 20-VERTICAL UNIT CROSSBAR SWITCH (200 POINT)

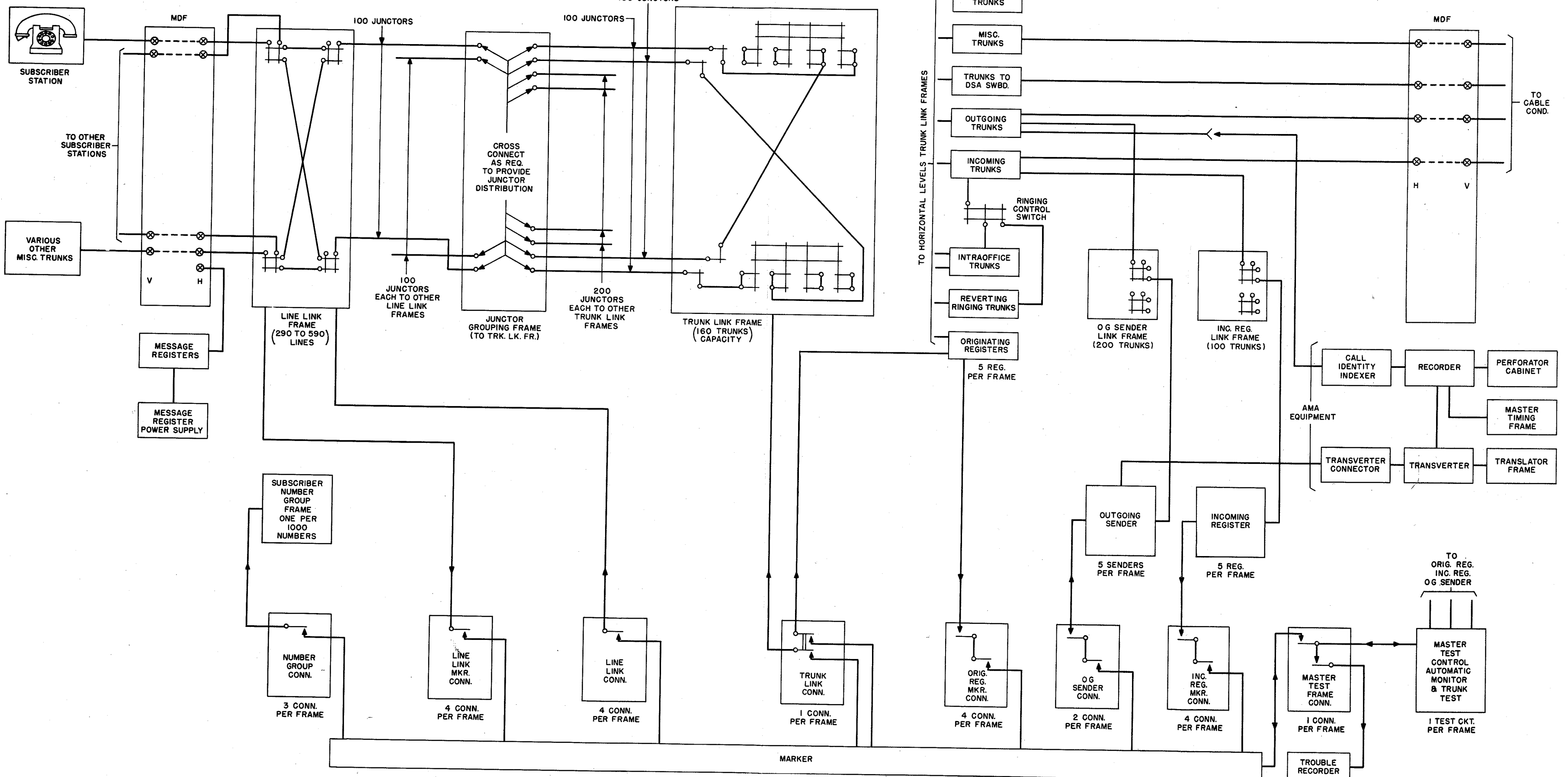

FIG. 2  
EQUIPMENT SCHEMATIC OF A NO. 5 CROSSBAR OFFICE

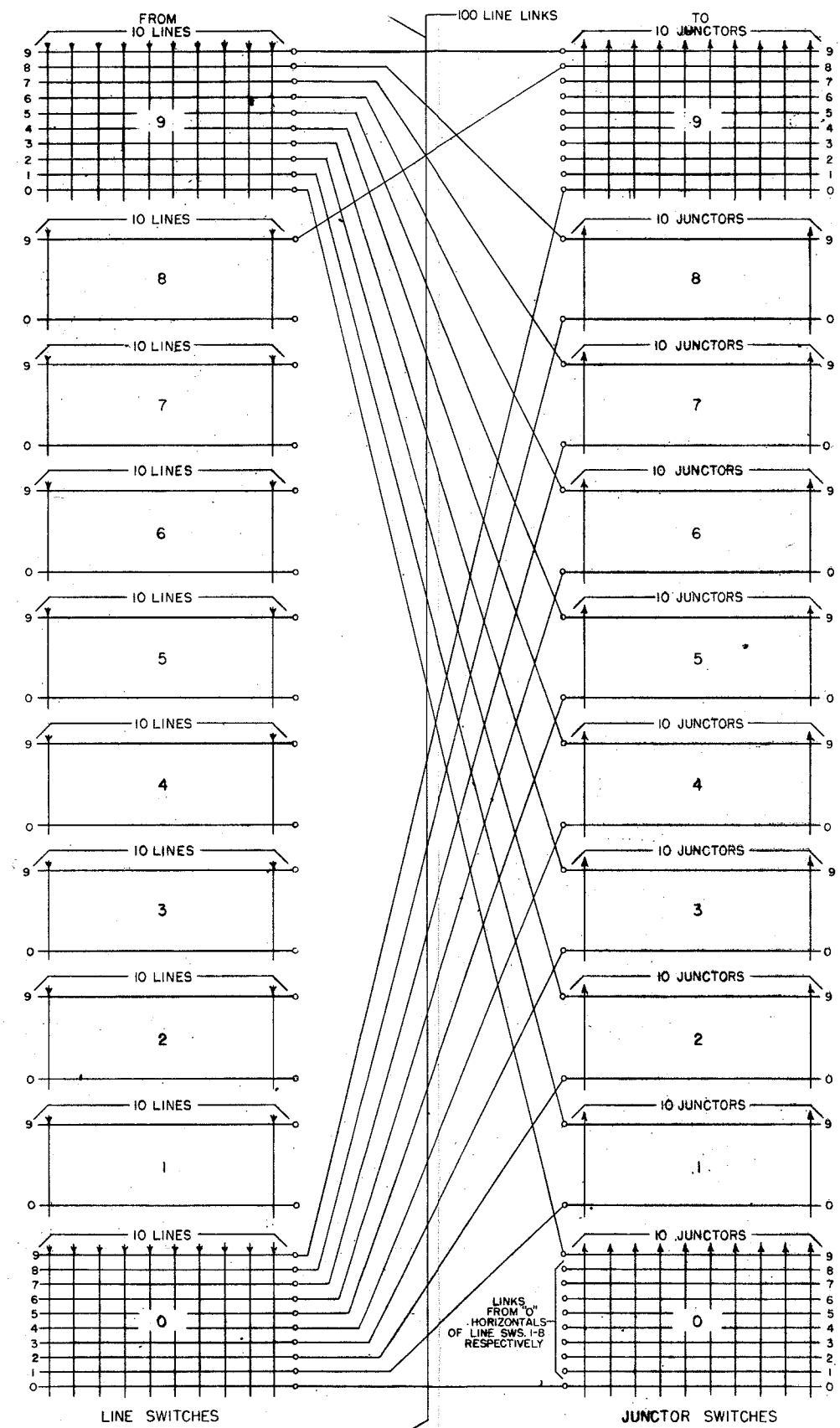

FIG. 4  
LINE LINK DISTRIBUTION

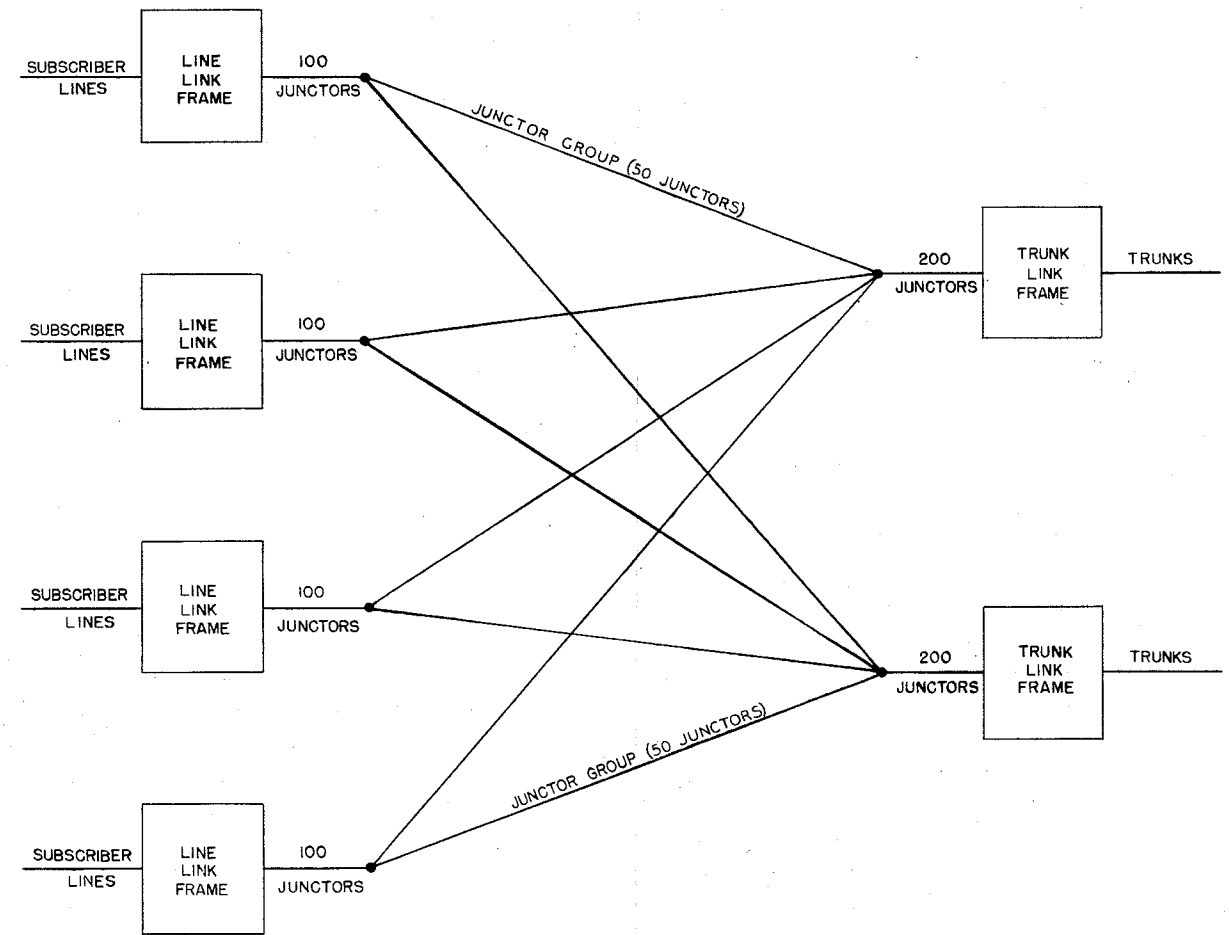

FIG. 5  
JUNCTOR DISTRIBUTION  
(4 LINE LINK AND 2 TRUNK LINK FRAMES)



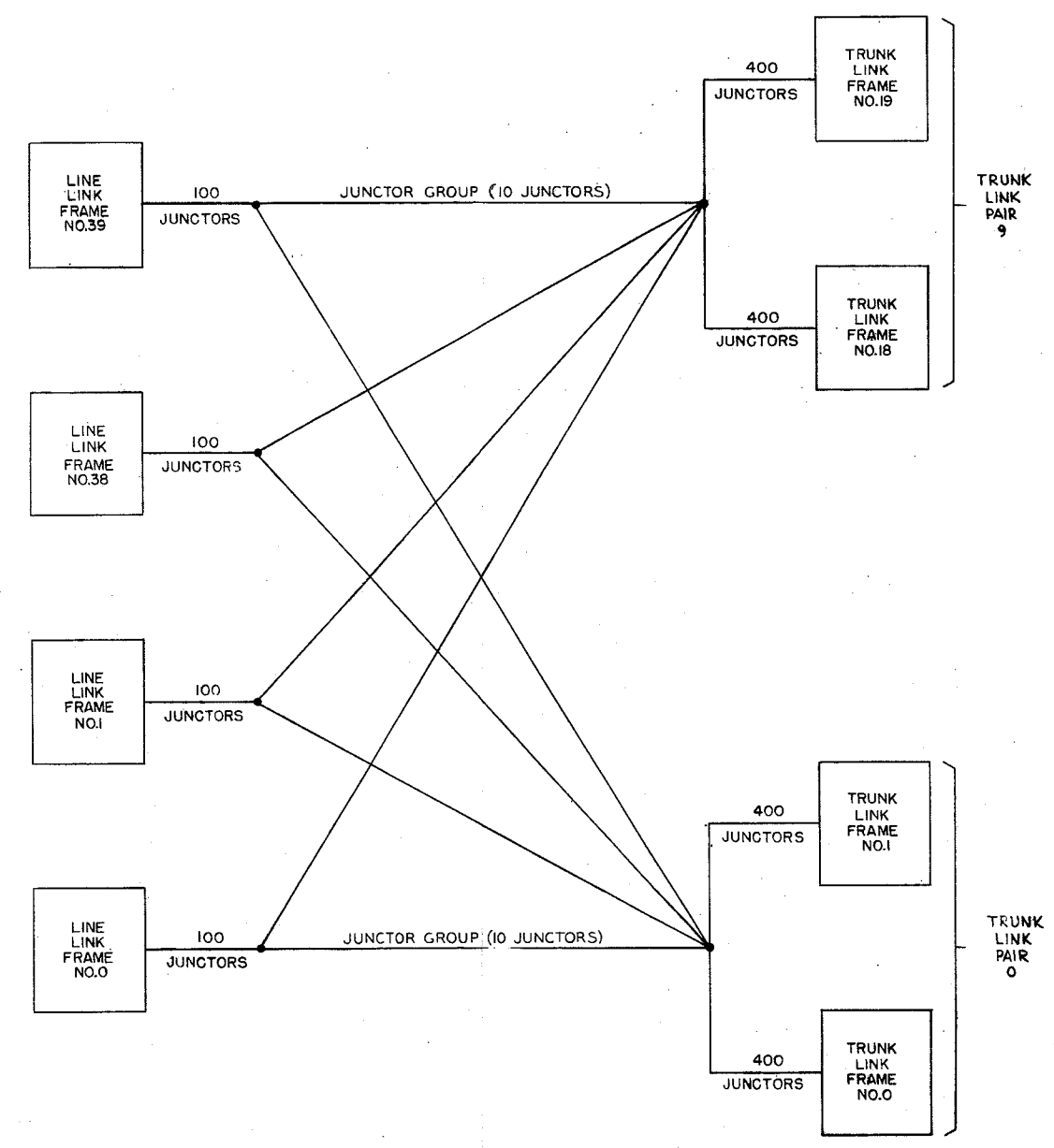

FIG. 6  
PAIRING OF TRUNK LINK FRAMES  
(40 LINE LINK AND 20 TRUNK LINK FRAMES)  
INITIAL INSTALLATION

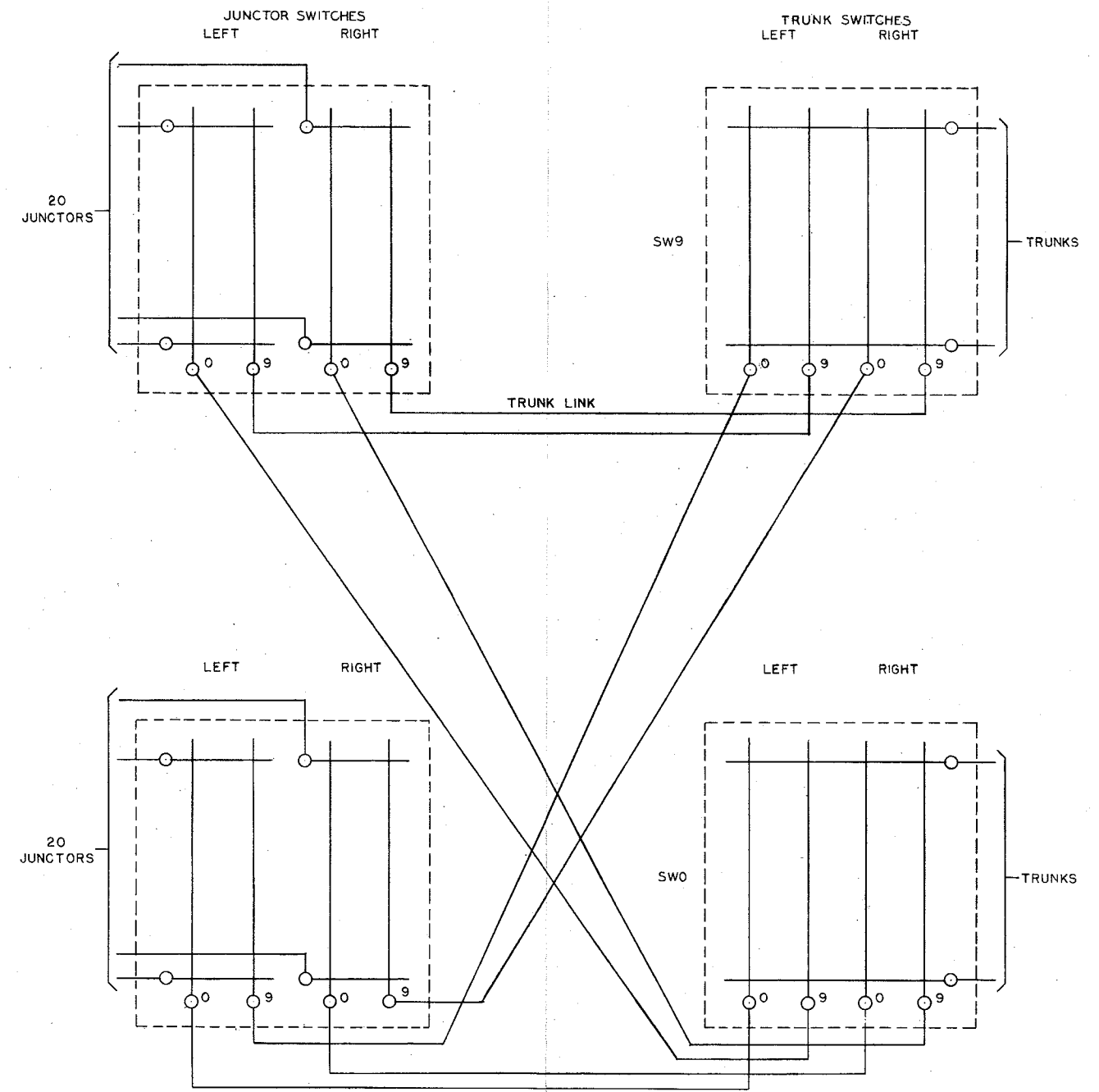

FIG. 8  
TRUNK LINK DISTRIBUTION

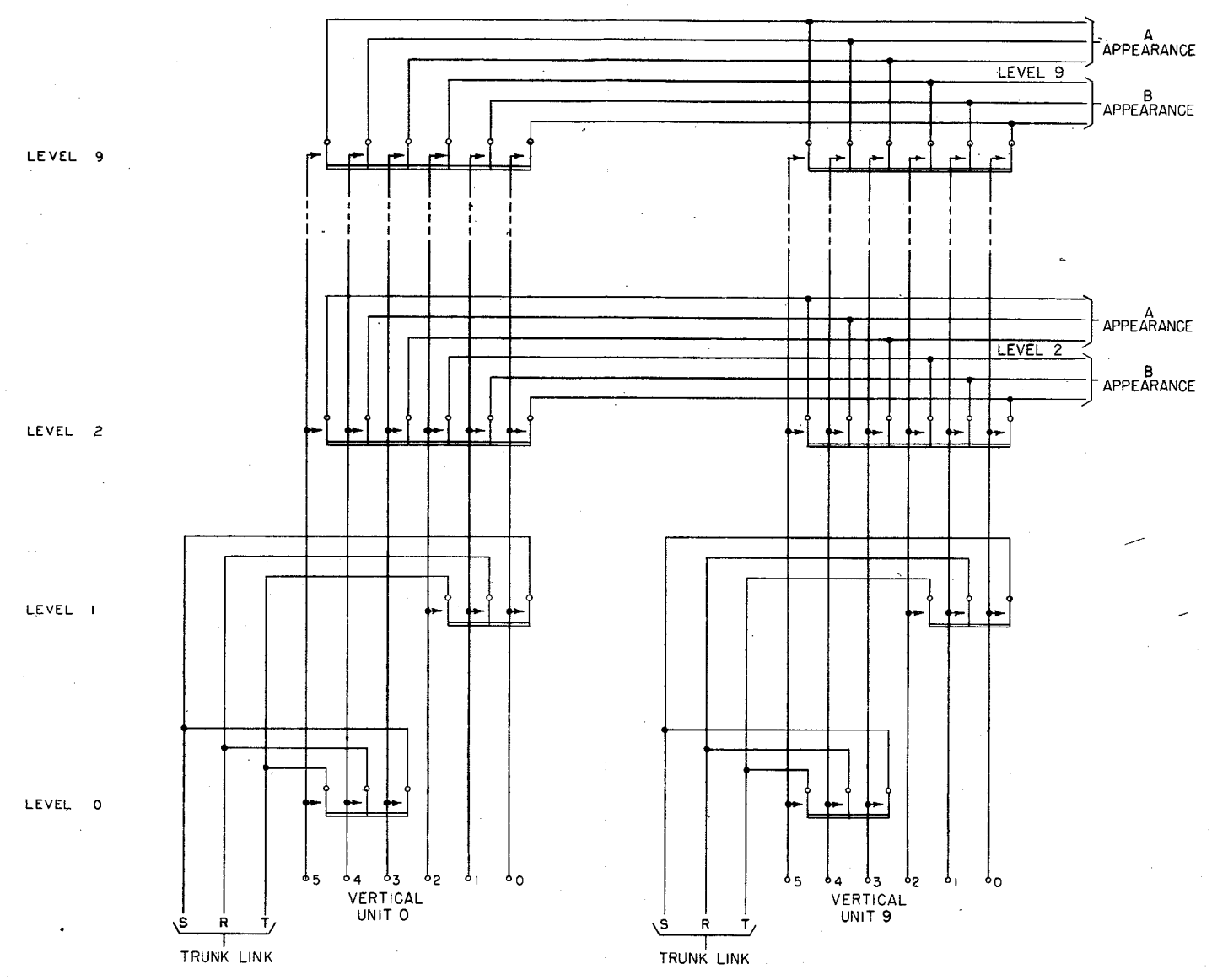
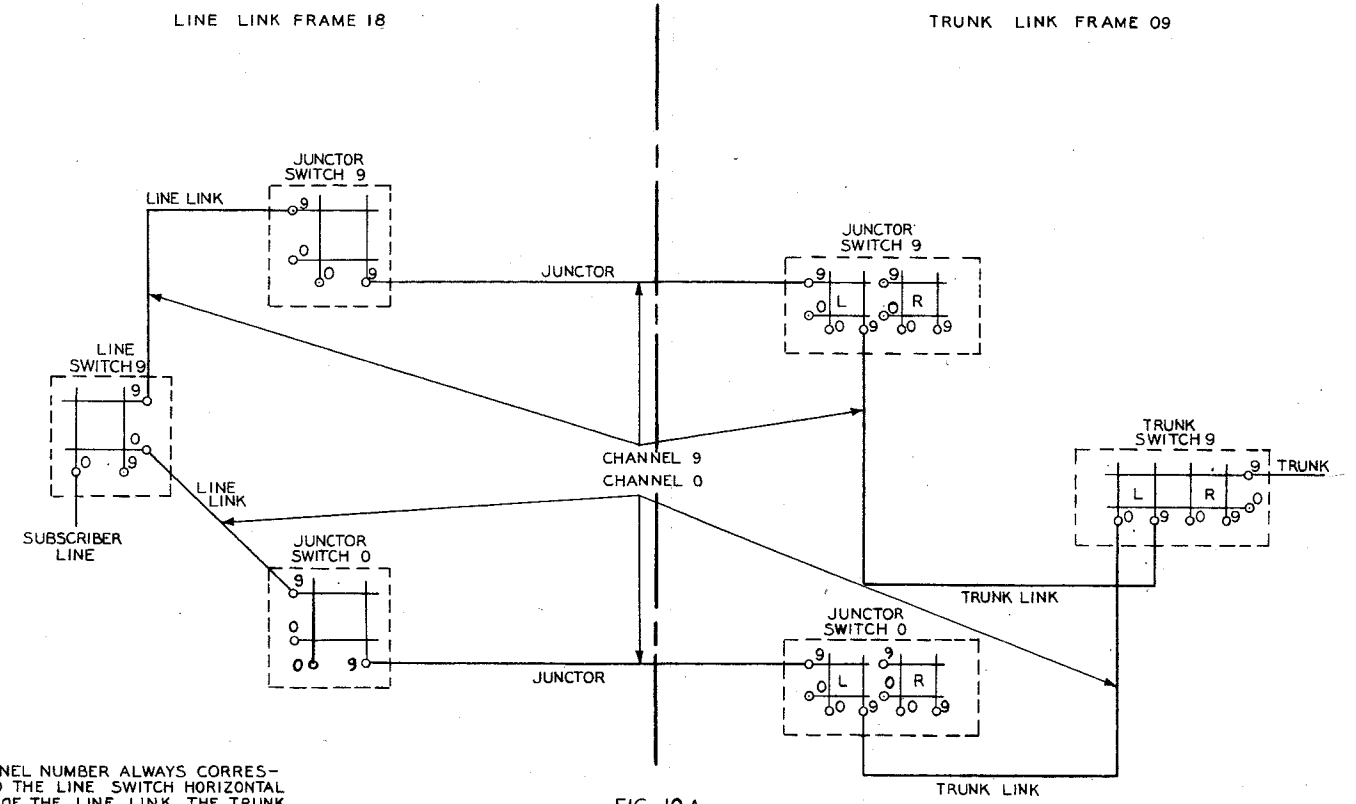

FIG. 9  
SWITCH ARRANGED FOR 16 TRUNK APPEARANCES ON TRUNK LINK FRAME



NOTE:  
 THE CHANNEL NUMBER ALWAYS CORRESPONDS TO THE LINE SWITCH HORIZONTAL NUMBER OF THE LINE LINK, THE TRUNK SWITCH VERTICAL NUMBER OF THE TRUNK LINK, AND THE JUNCTOR SWITCH NUMBER. ALL OTHER ELEMENTS ARE NUMBERED INDEPENDENTLY OF CHANNEL NUMBER CONSIDERATIONS

FIG. 10A  
 CHANNELS FOR 20 LINE LINK-10 TRUNK LINK FRAMES

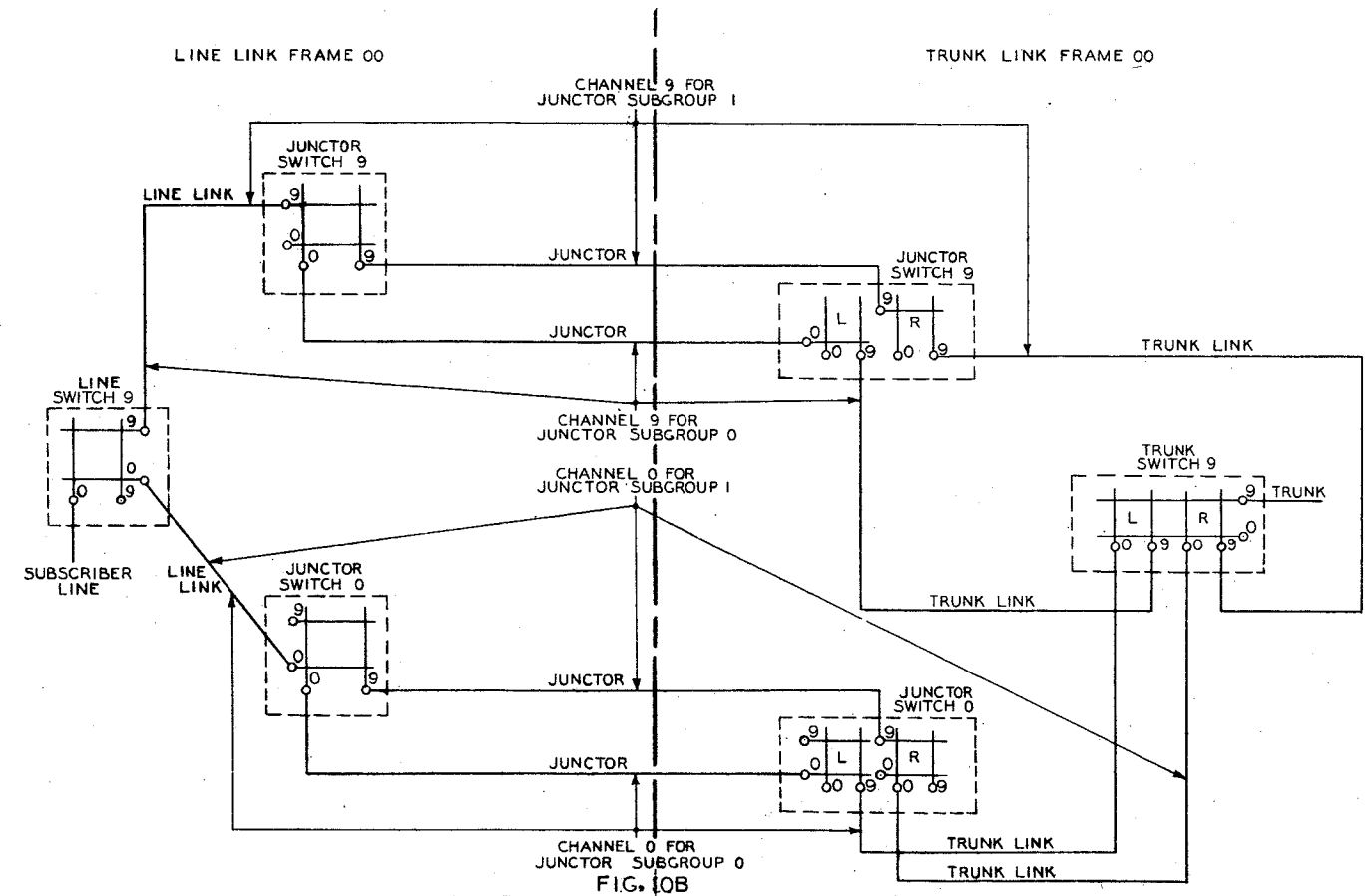

FIG. 10B  
 CHANNELS FOR 10 LINE LINK-5 TRUNK LINK FRAMES

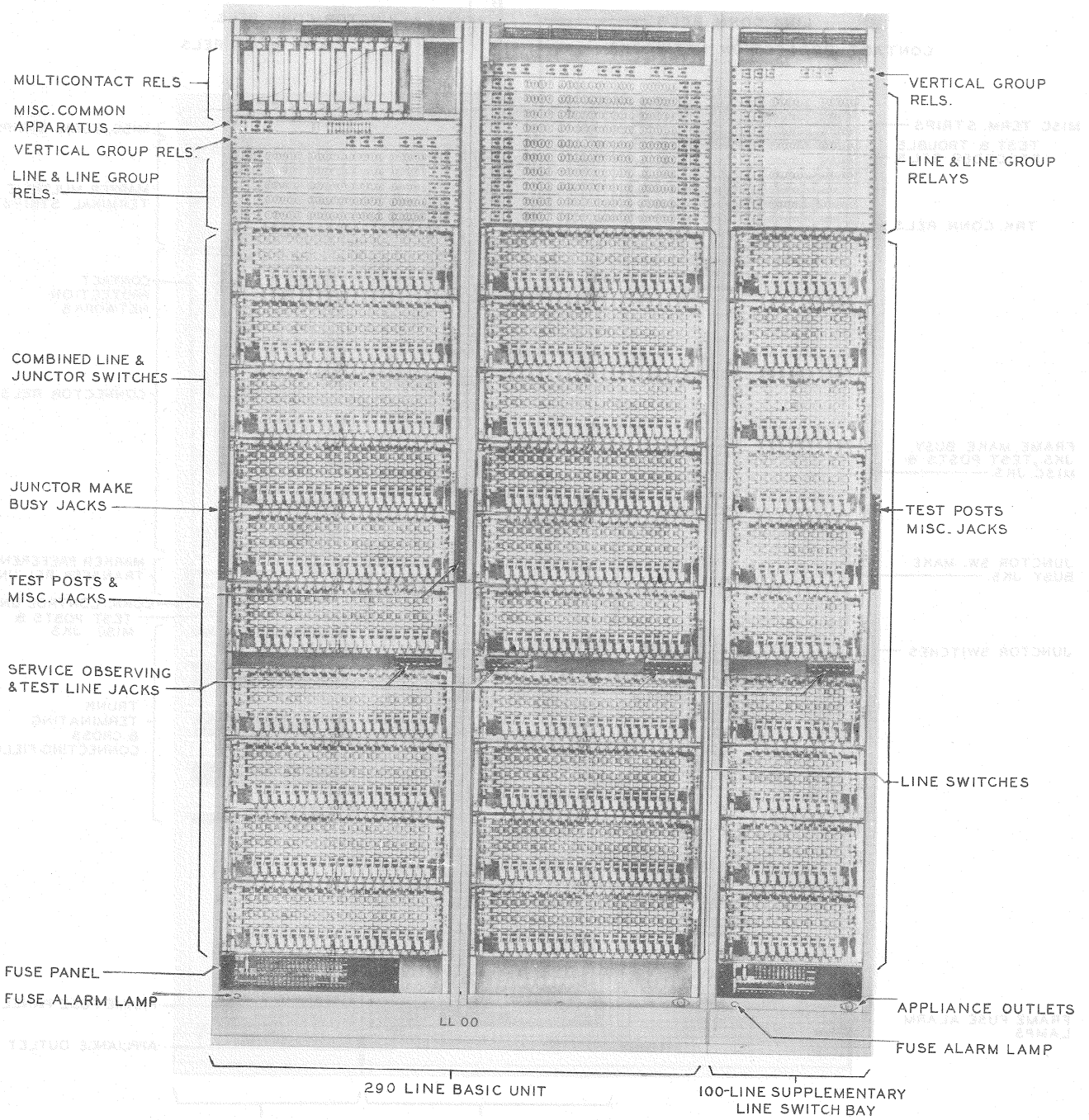

FIG. II  
 LINE LINK FRAME AND SUPPLEMENTARY LINE SWITCH BAY

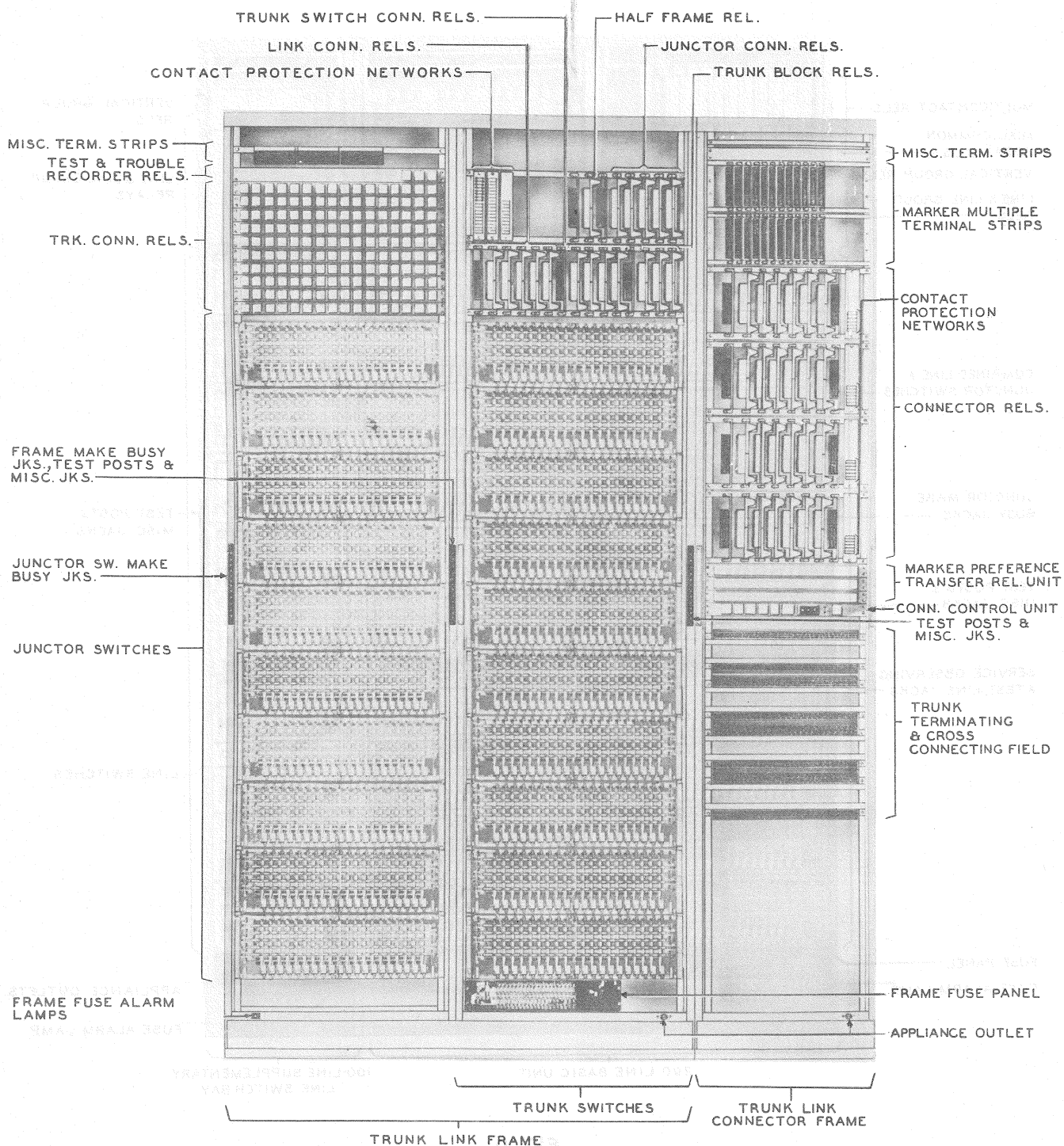

FIG. 12  
 TRUNK LINK FRAME AND TRUNK  
 LINK CONNECTOR FRAME

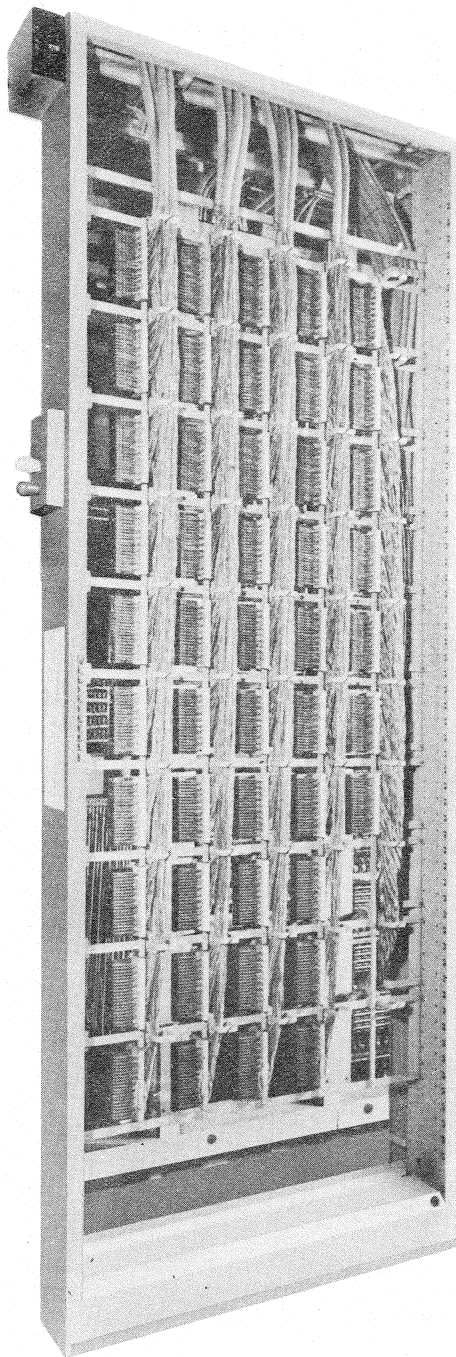

FIG.13- JUNCTOR GROUPING FRAME

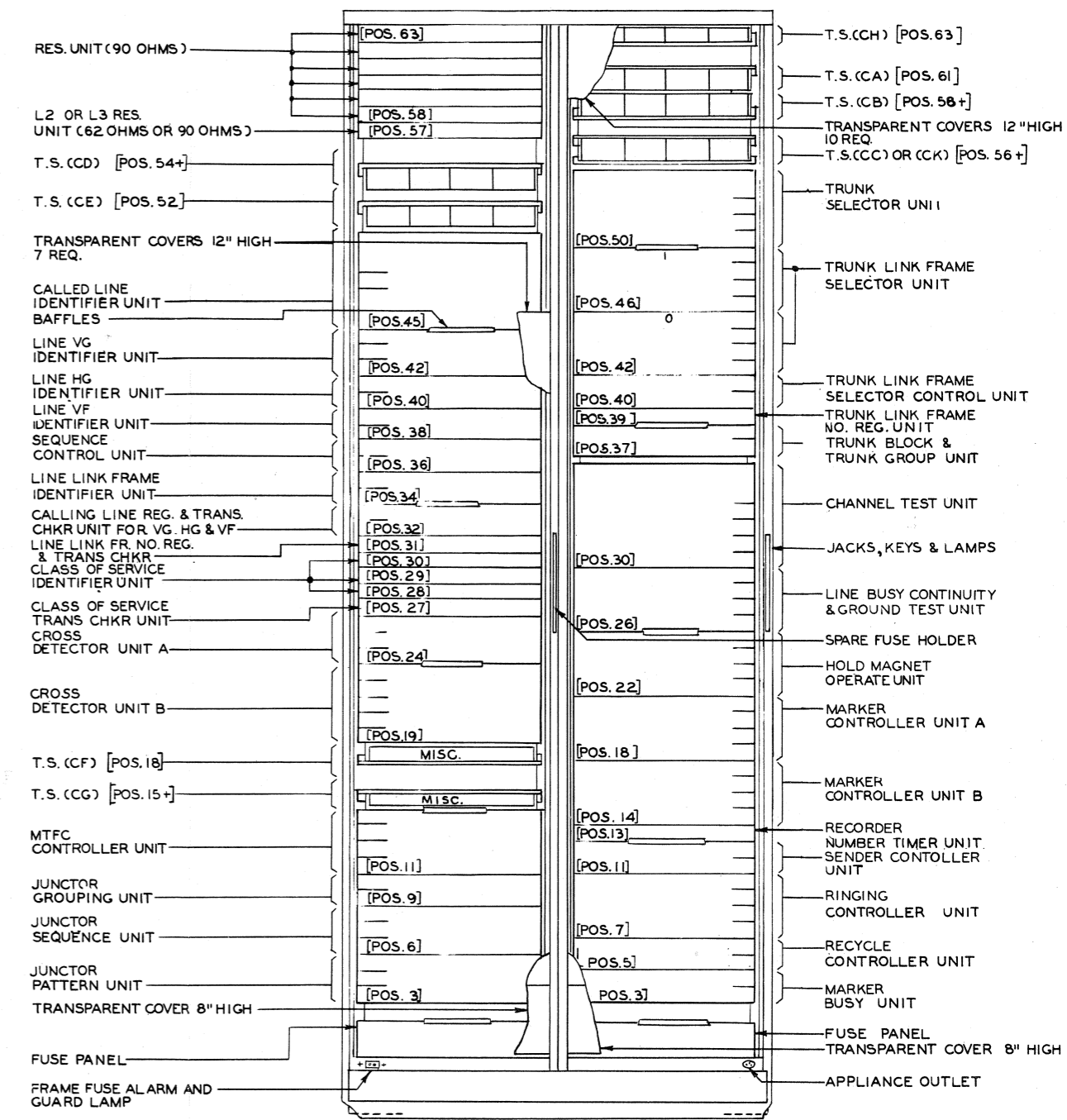
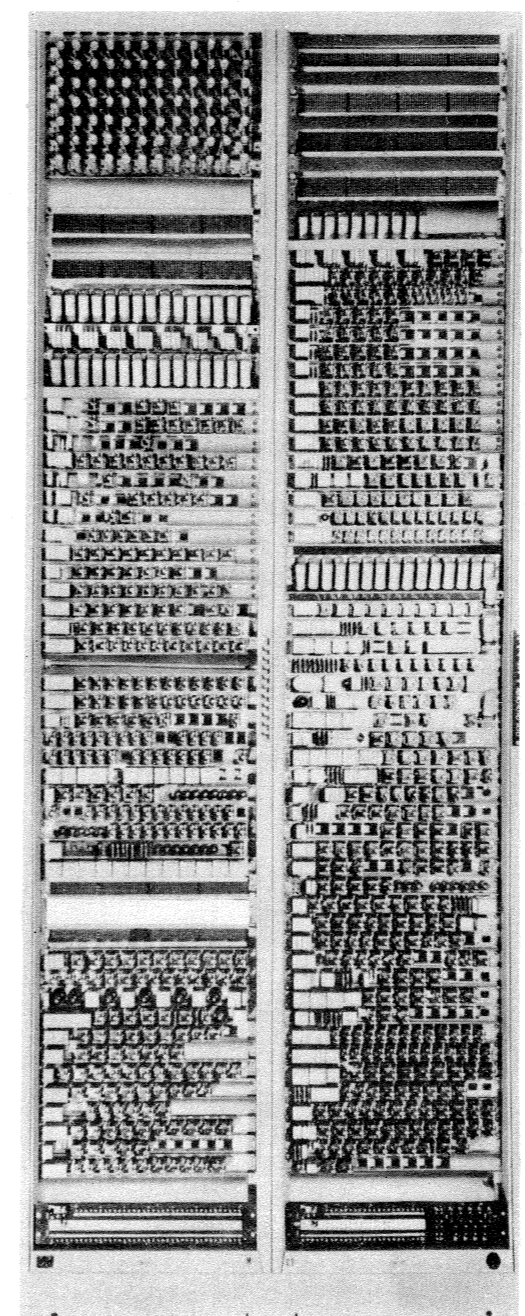

FIG. 14  
MARKER FRAME  
COMMON EQUIPMENT FRAME



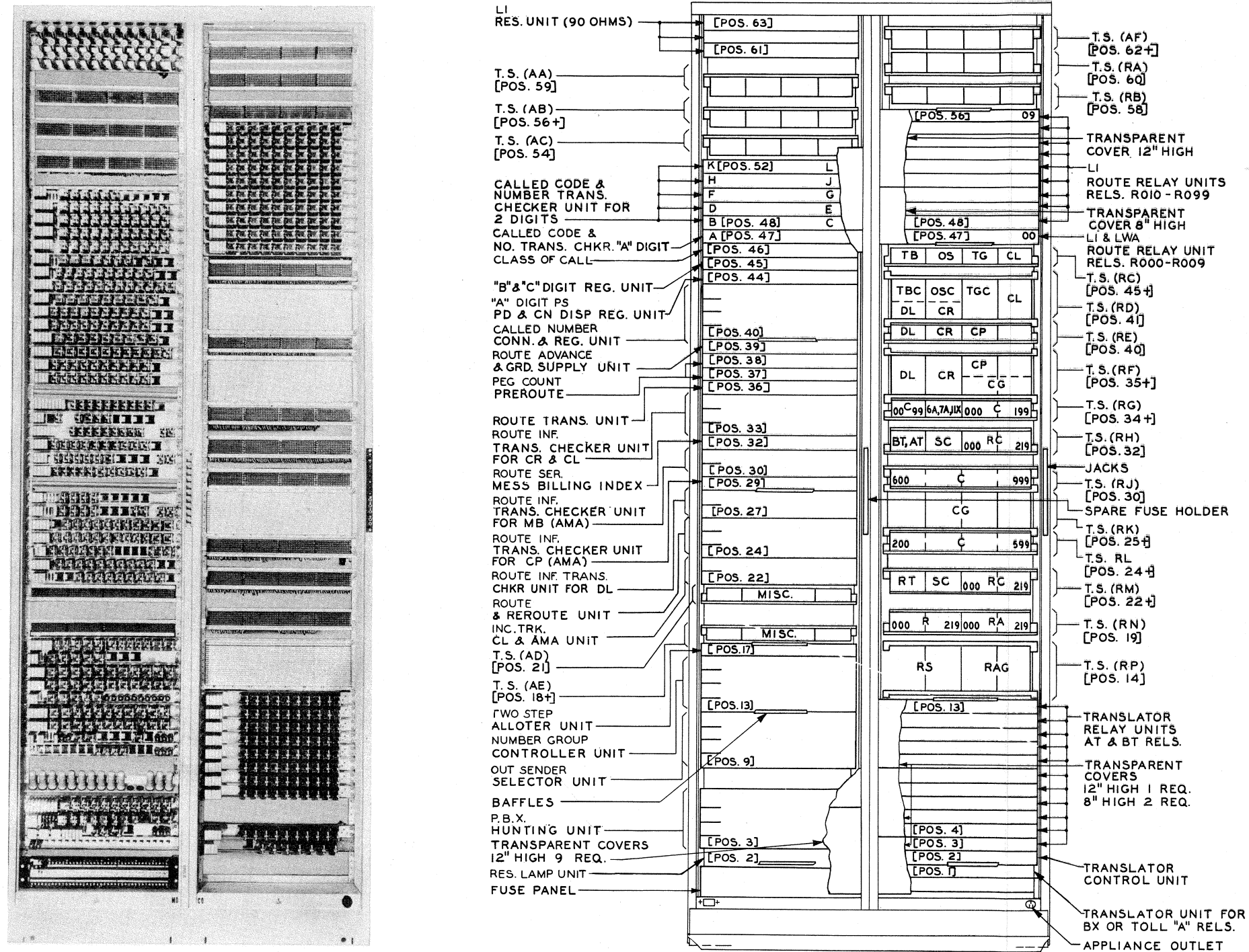
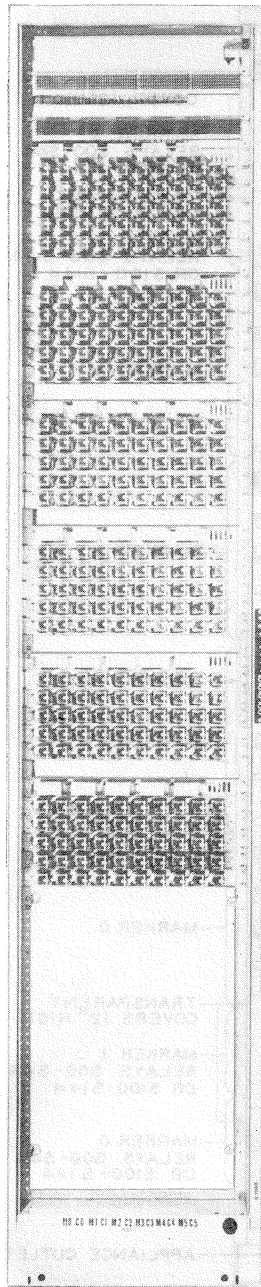
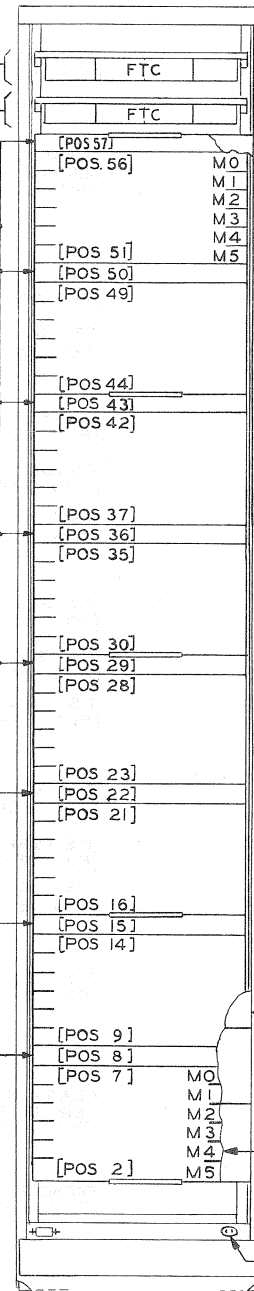

FIG. 15  
MARKER FRAME  
TRANSLATOR AND ROUTE RELAY FRAME



10 OR 20 T.L. FR. { T.S.(C) [POS. 61+]  
T.S.(D) [POS. 59]

CONTACT PROTECTION UNIT FOR TEST LEAD CONN. RELAYS



TEST LEAD CONN RELAY UNITS

JACKS

TRANSPARENT COVERS 12" HIGH 8 REQ.

TRANSPARENT COVERS 8" HIGH 2 REQ.

APPLIANCE OUTLET

FIG. 16  
MARKER FRAME  
TRUNK FRAME TEST LEAD CONNECTOR BAY

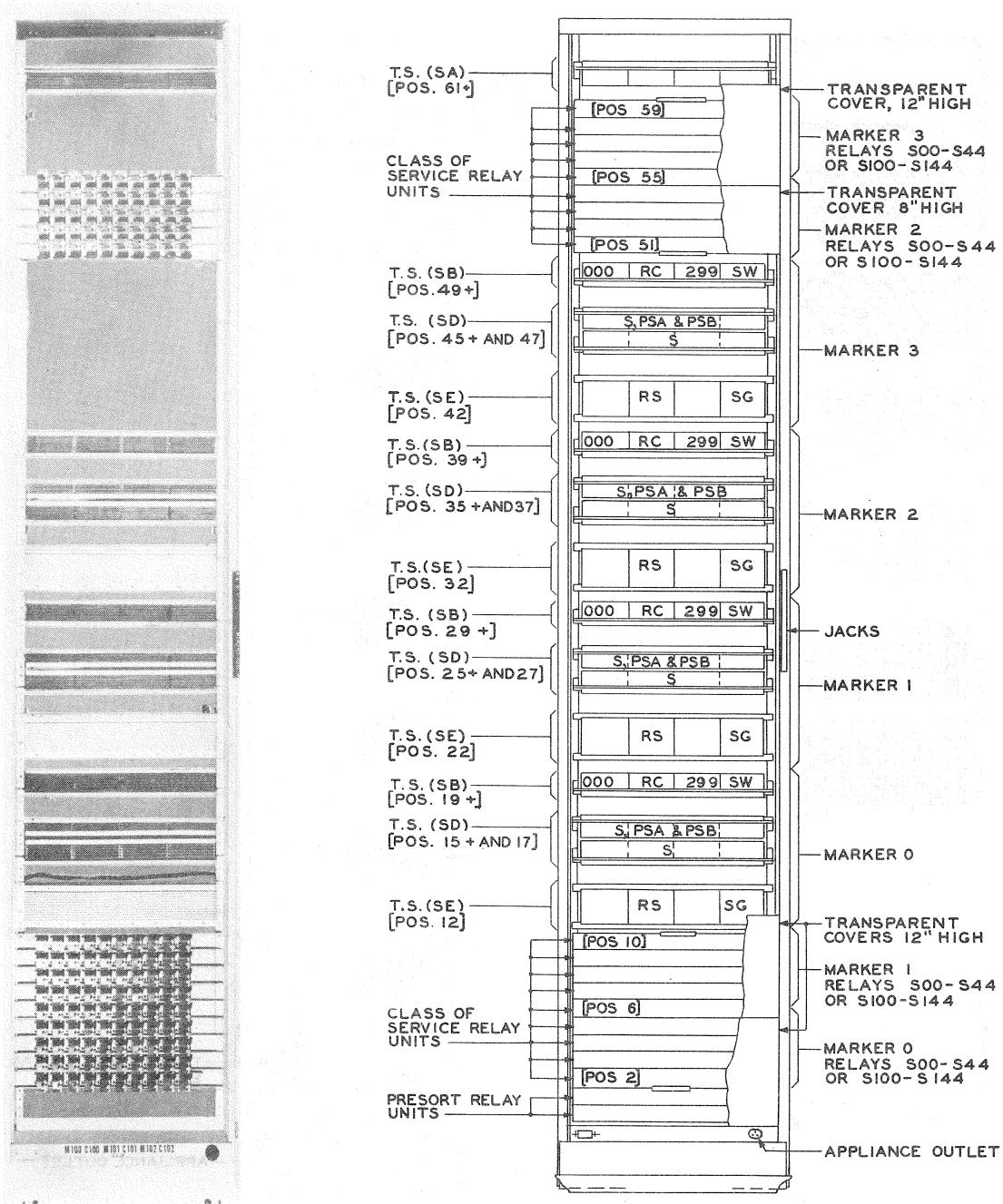
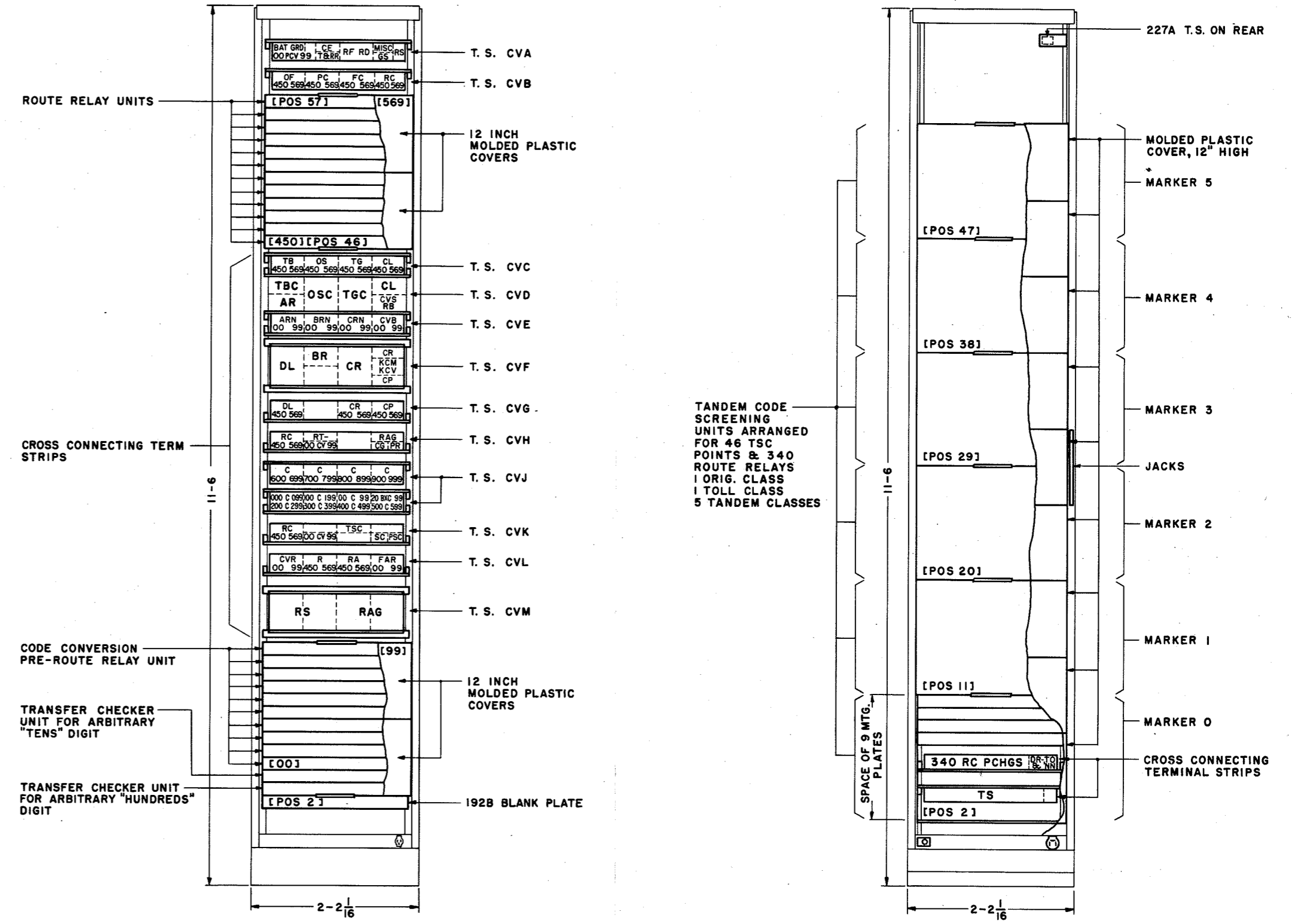

FIG. 17  
 MARKER FRAME  
 CLASS OF SERVICE BAY



CODE CONVERSION AND ROUTE RELAY FRAME

TANDEM CODE SCREENING FRAME

FIG. 18-CODE CONVERSION AND TANDEM CODE SCREENING FRAMES

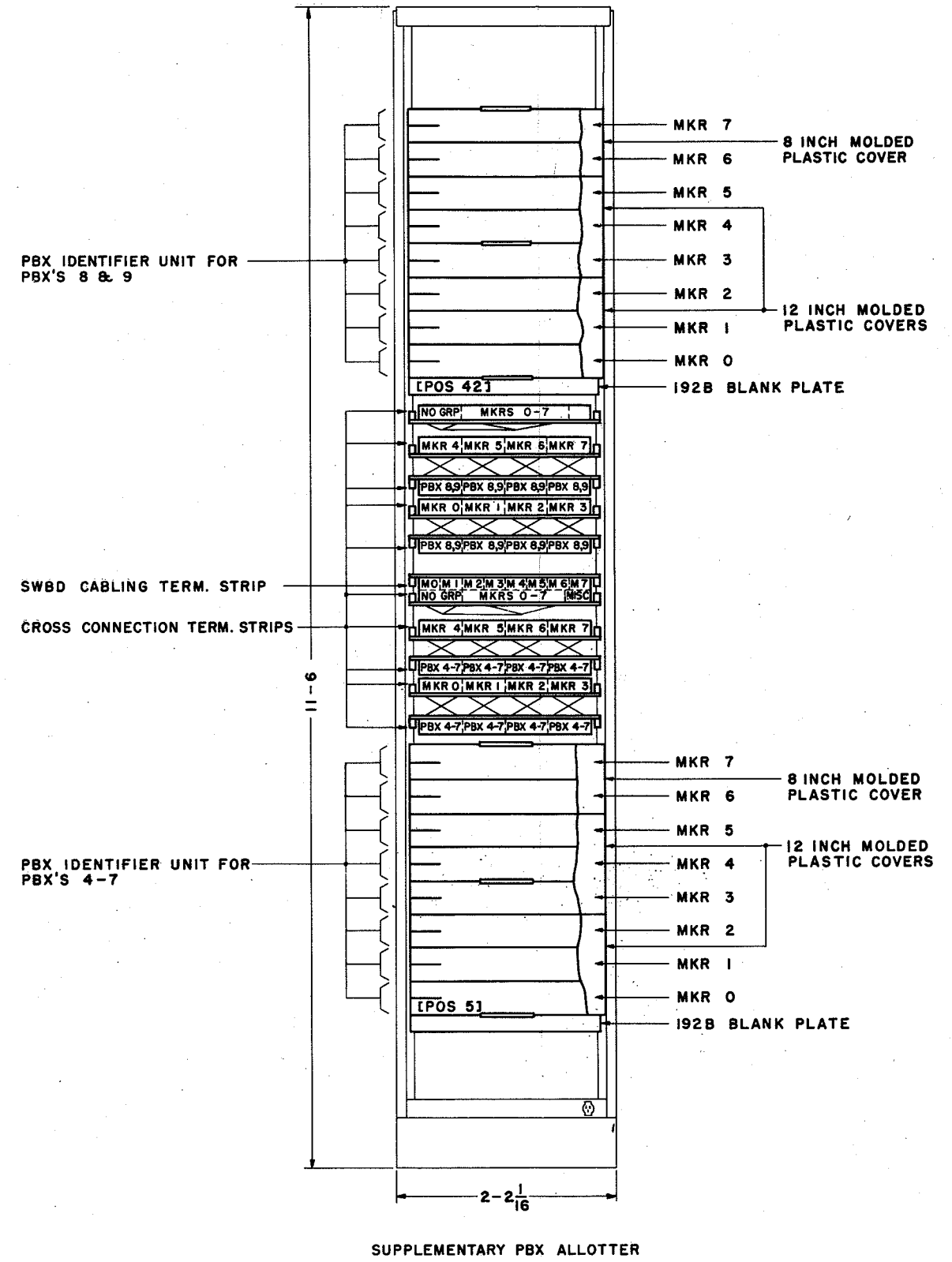
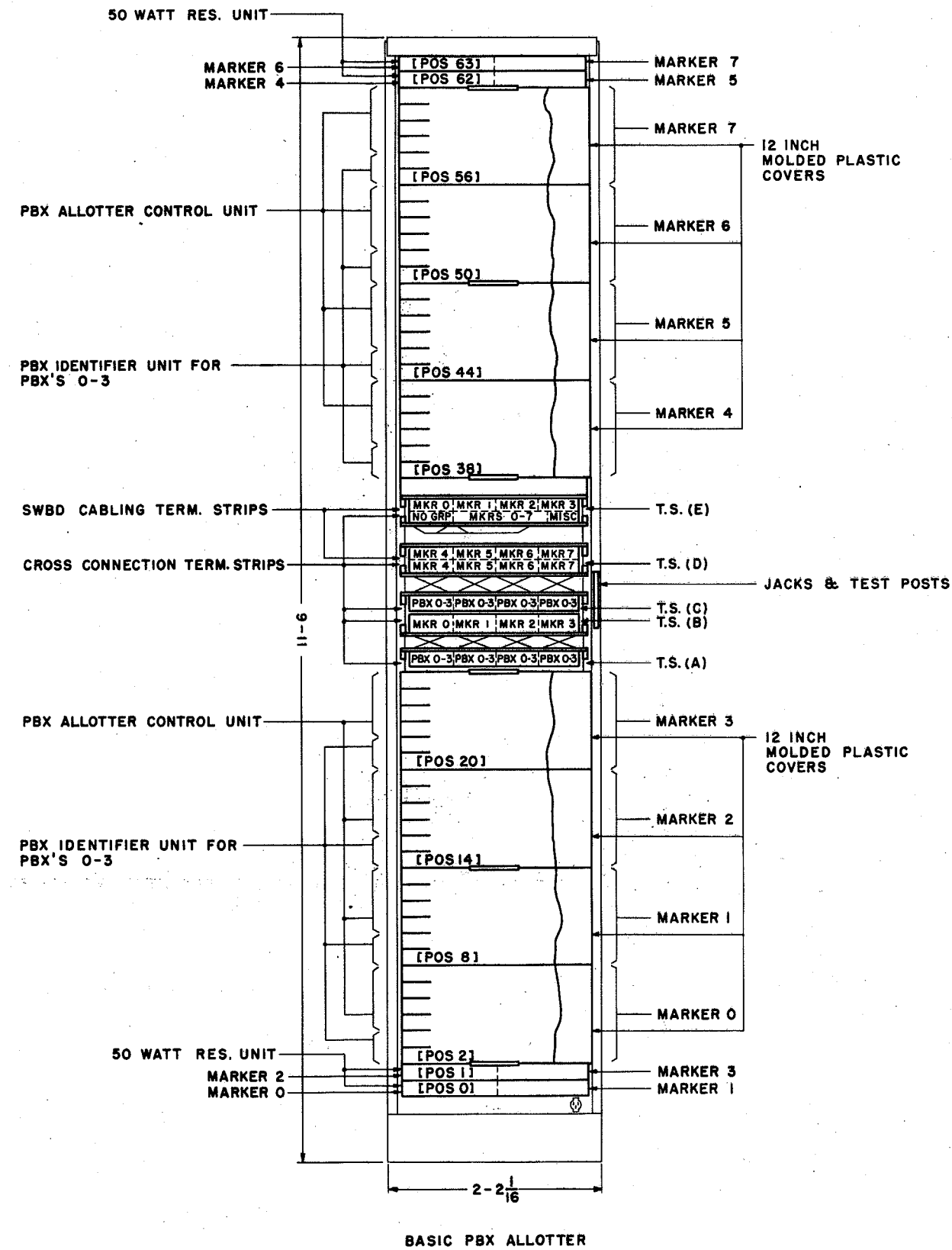

FIG. 19-PBX ALLOTTER

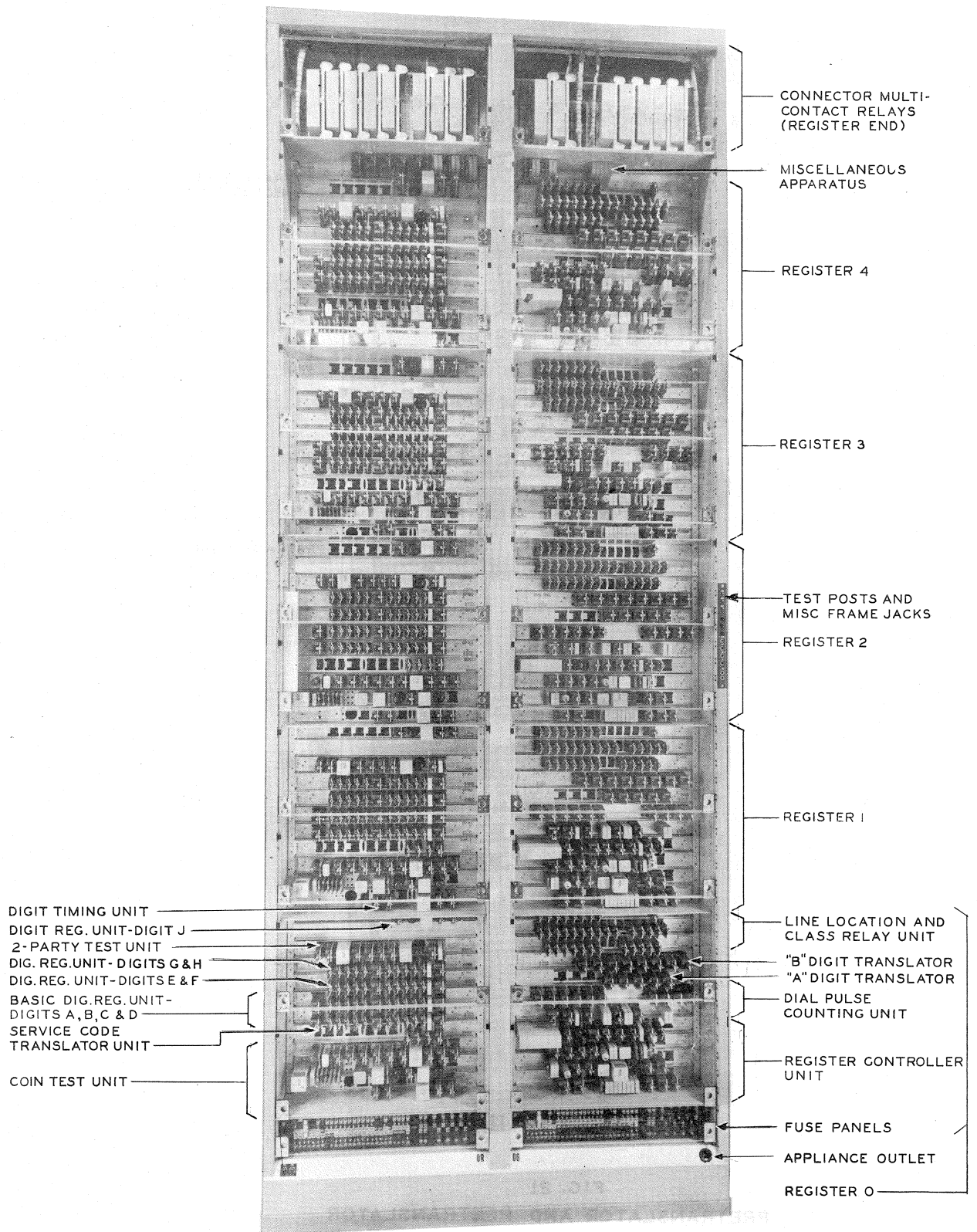

FIG. 20  
ORIGINATING REGISTER FRAME

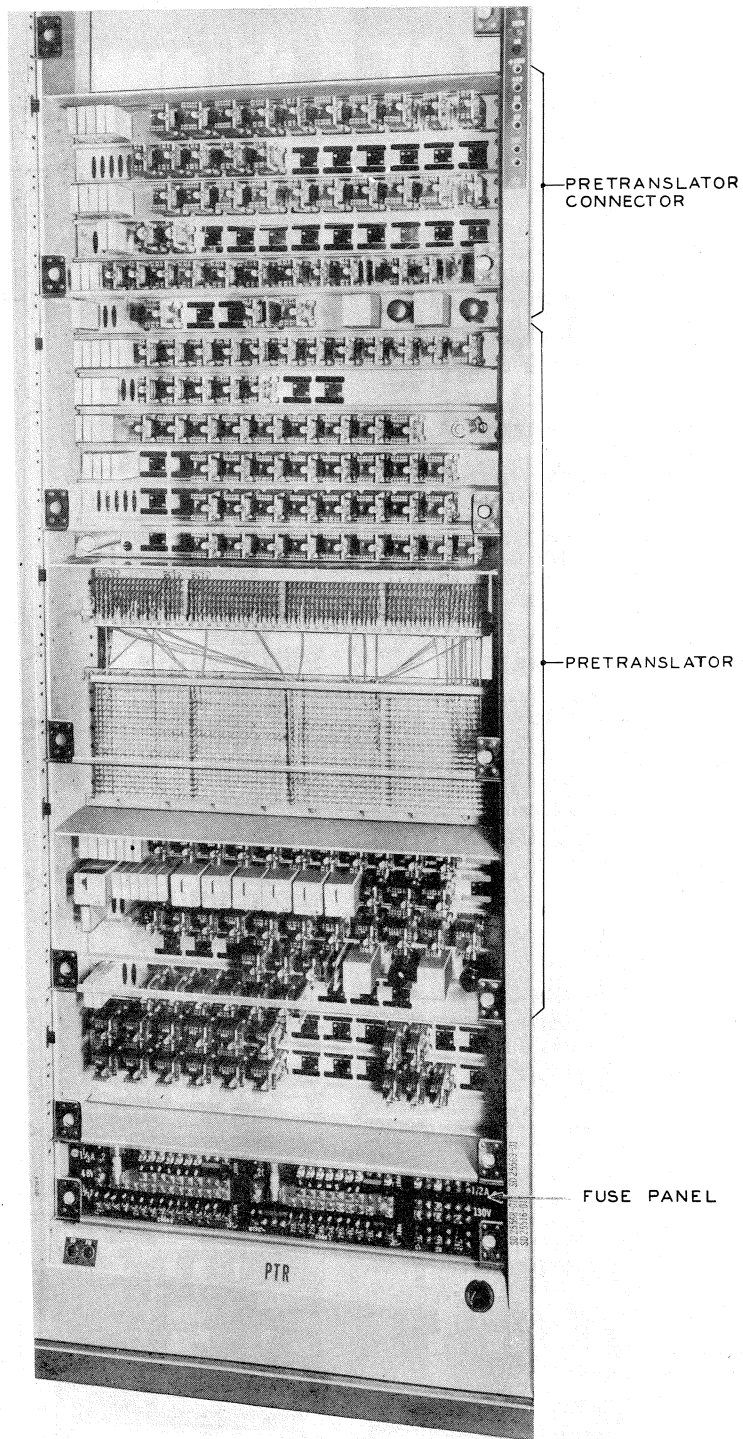

FIG. 21  
PRETRANSLATOR AND PRETRANSLATOR  
CONNECTOR FRAME

UNCLASSIFIED

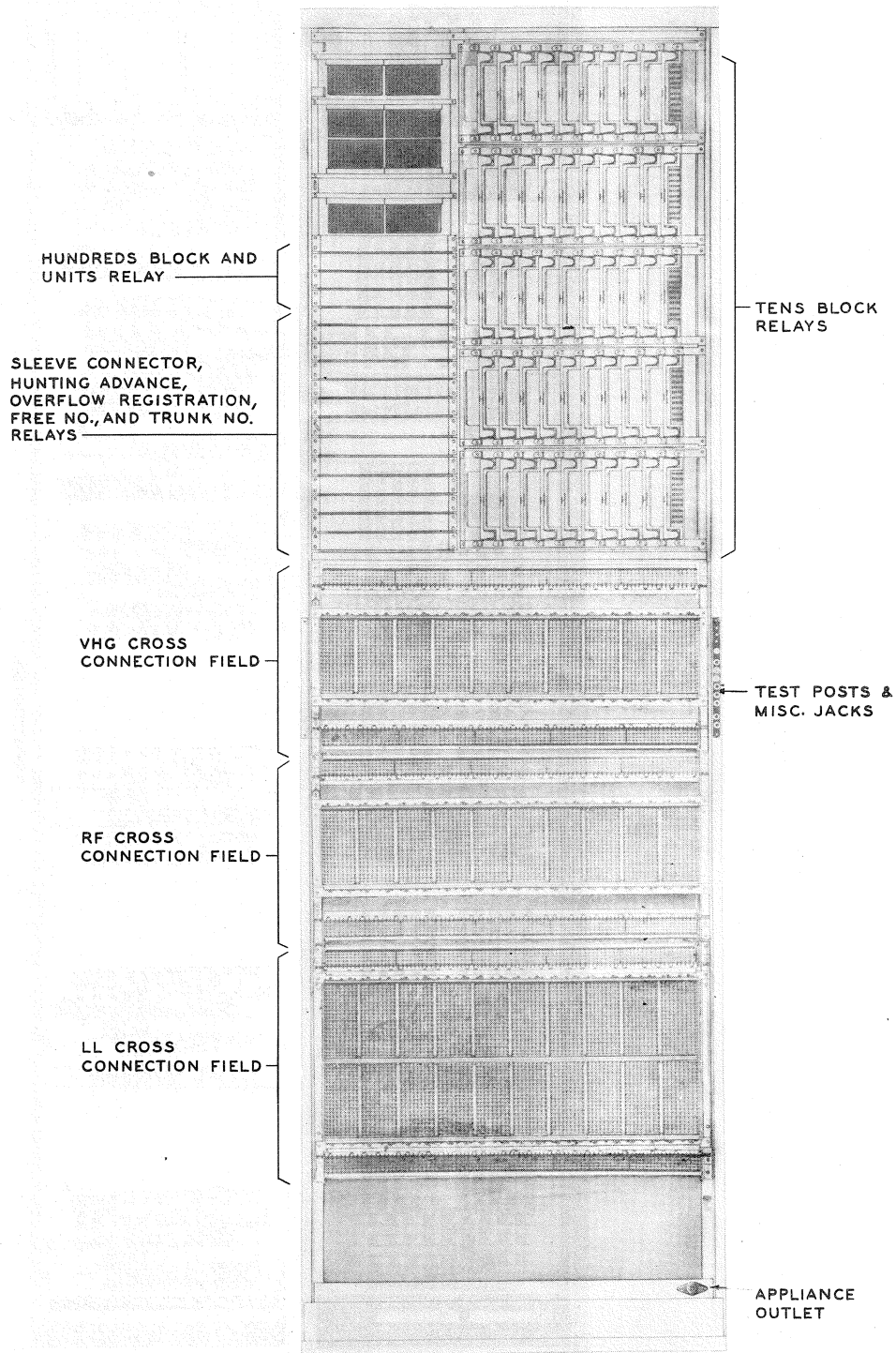

FIG. 22  
NUMBER GROUP FRAME



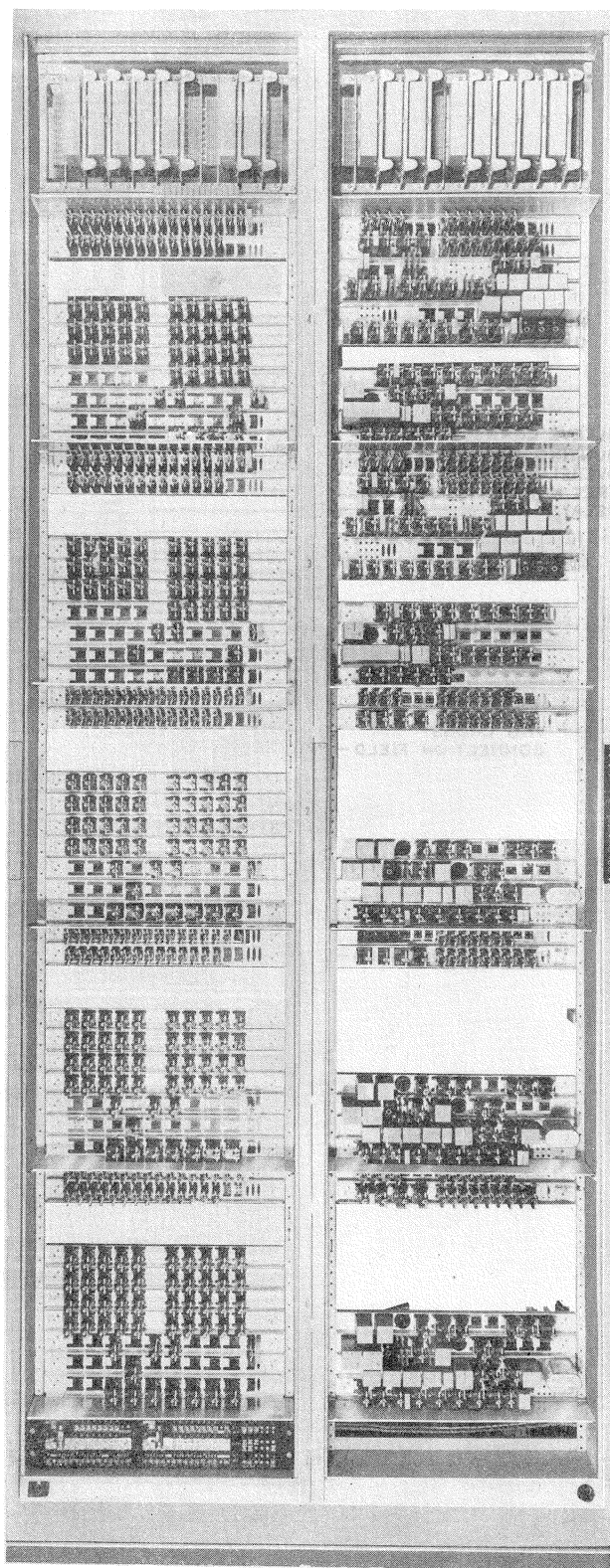

FIG. 23  
OUTGOING SENDER FRAME

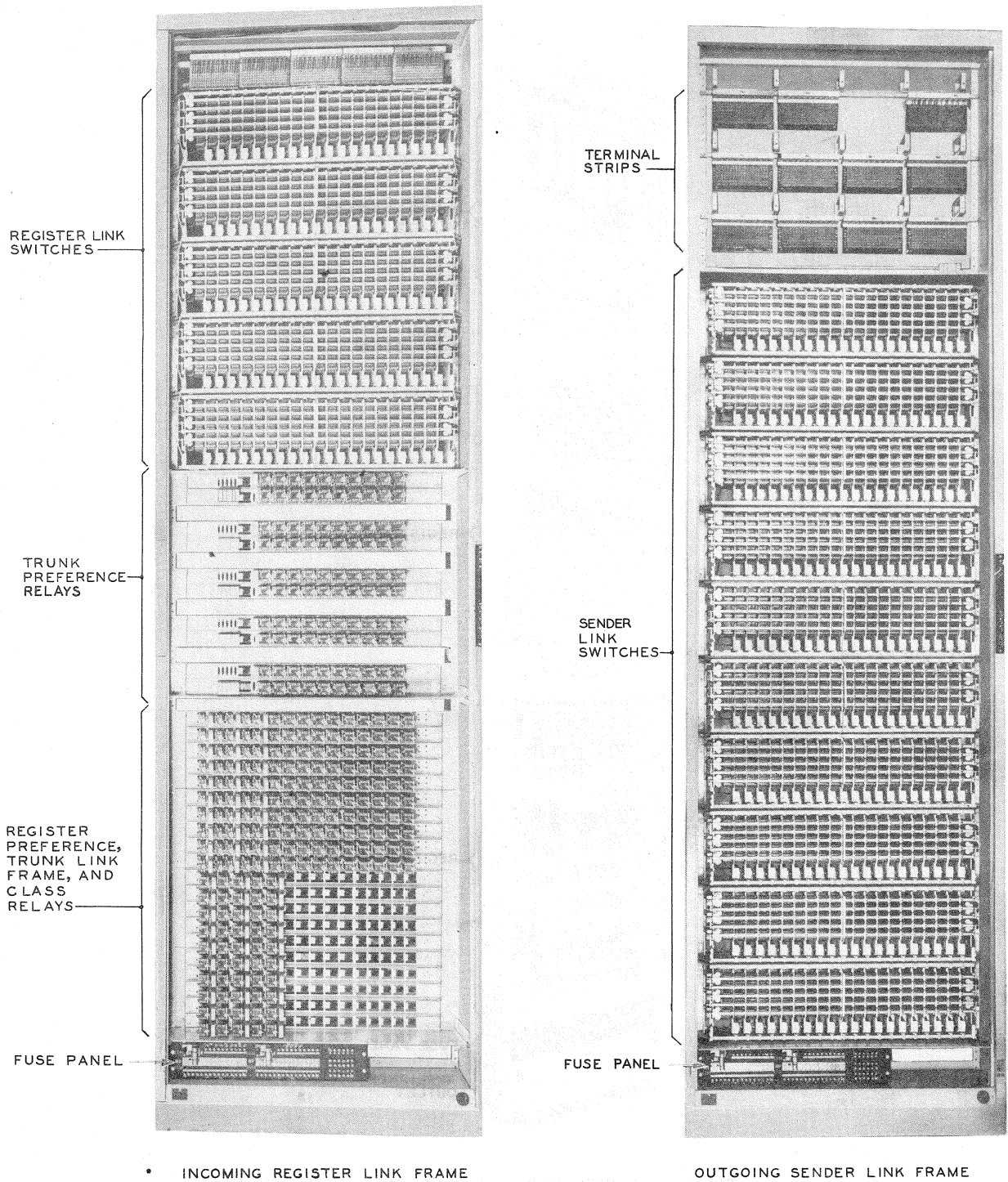

FIG. 24  
REGISTER AND SENDER LINK FRAMES

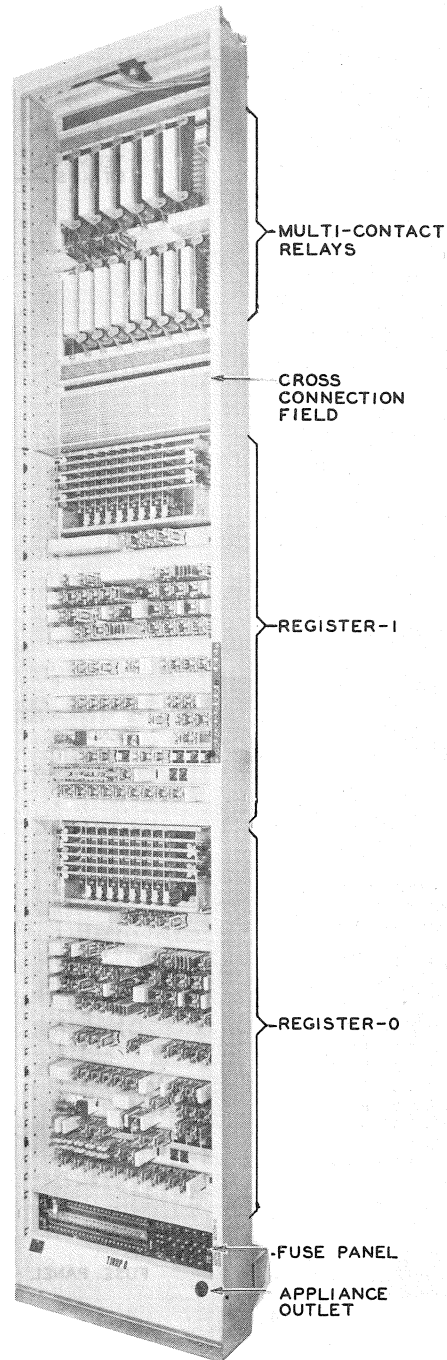
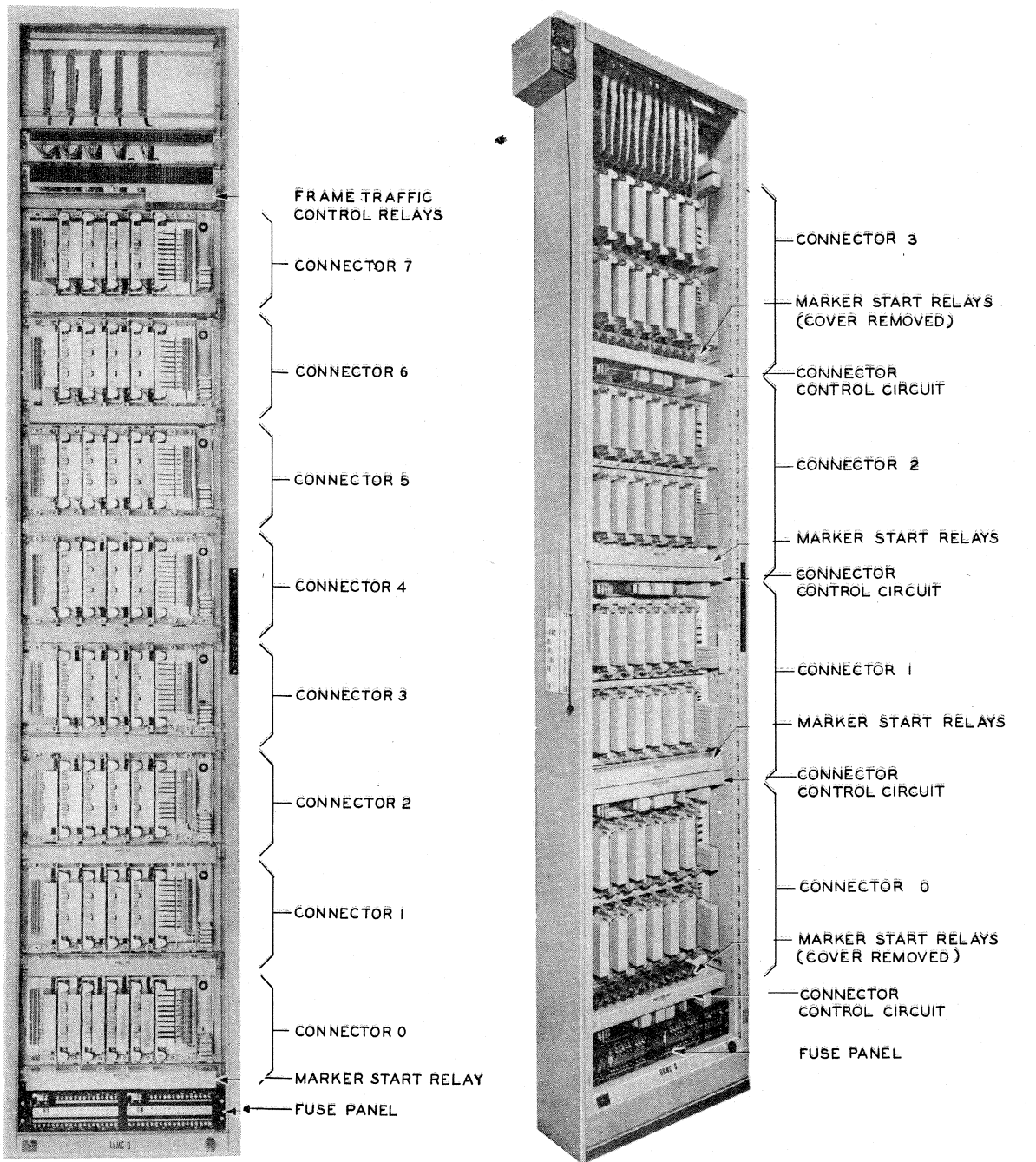

FIG. 25 - TANDEM REVERTIVE PULSE INCOMING REGISTER



LINE LINK MARKER CONNECTOR

ORIGINATING REGISTER MARKER CONNECTOR

FIG. 26  
MARKER CONNECTOR FRAMES

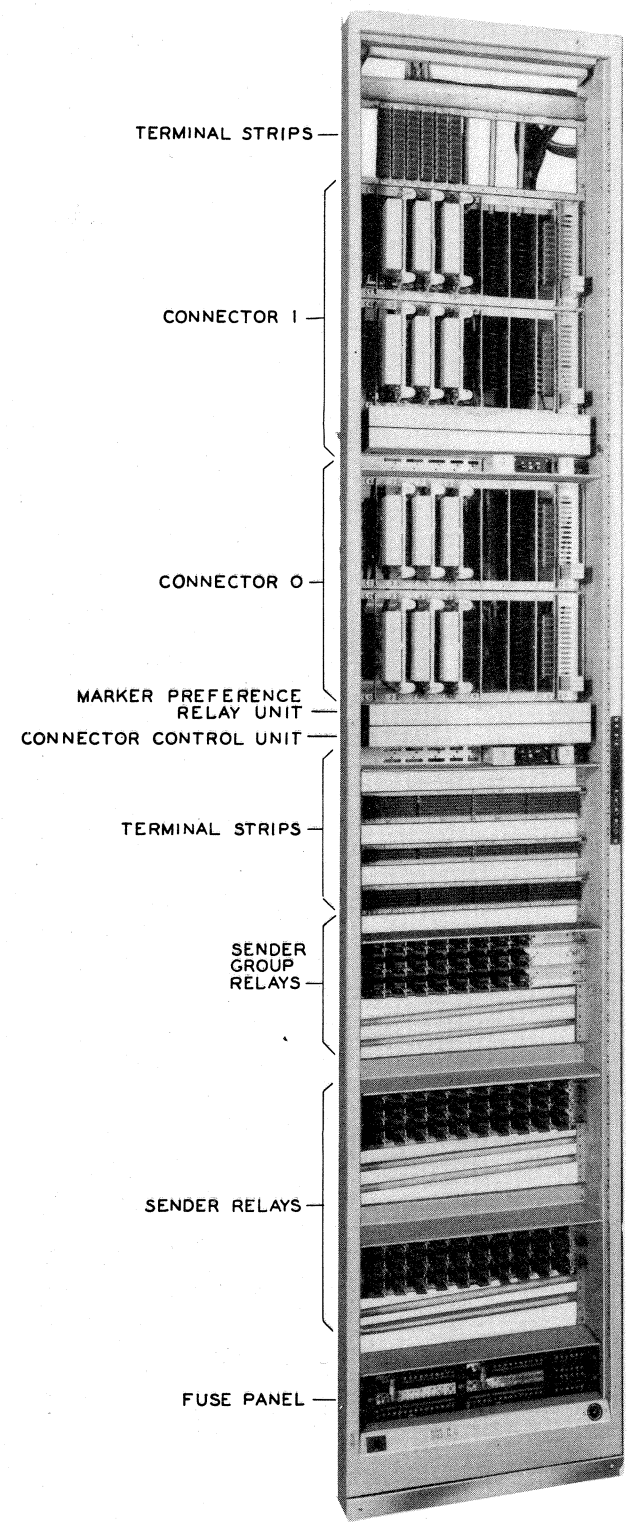

OUTGOING SENDER CONNECTOR

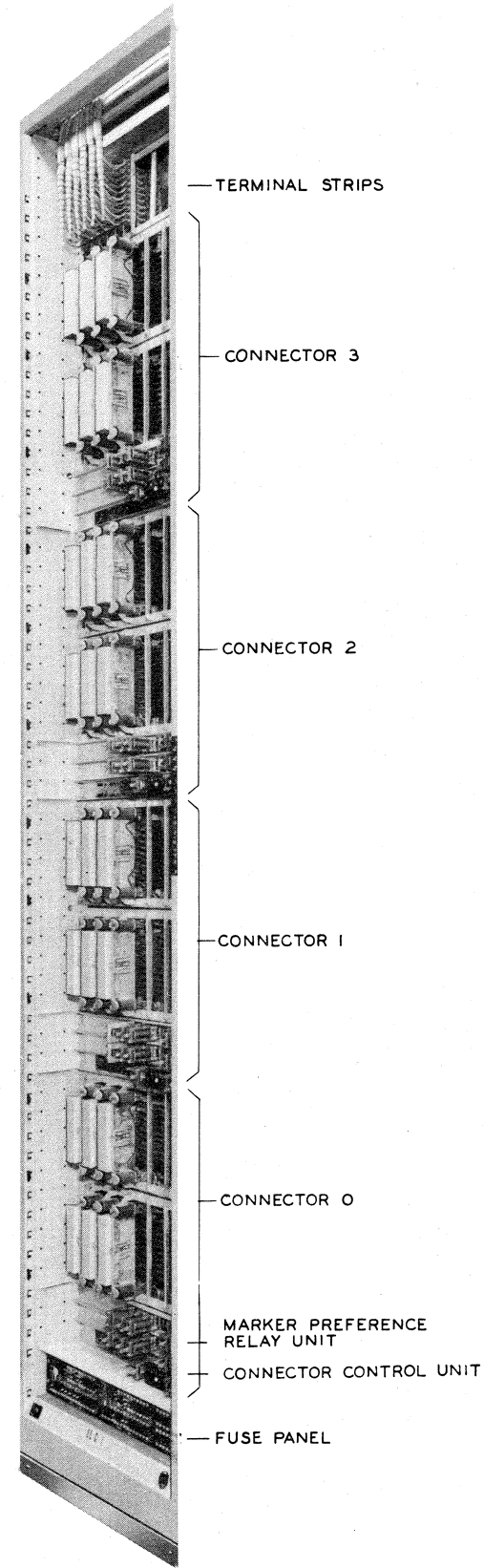

LINE LINK CONNECTOR

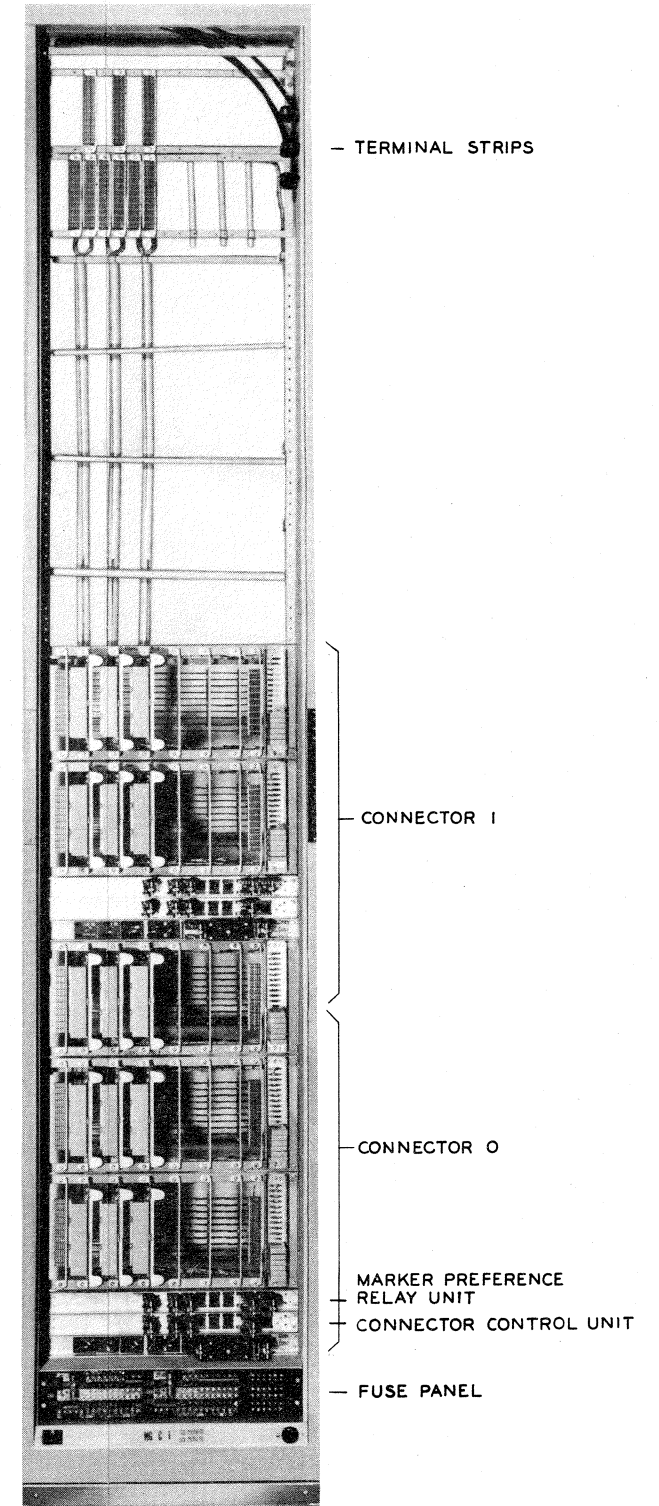

NUMBER GROUP CONNECTOR

FIG. 27  
CONNECTOR FRAMES

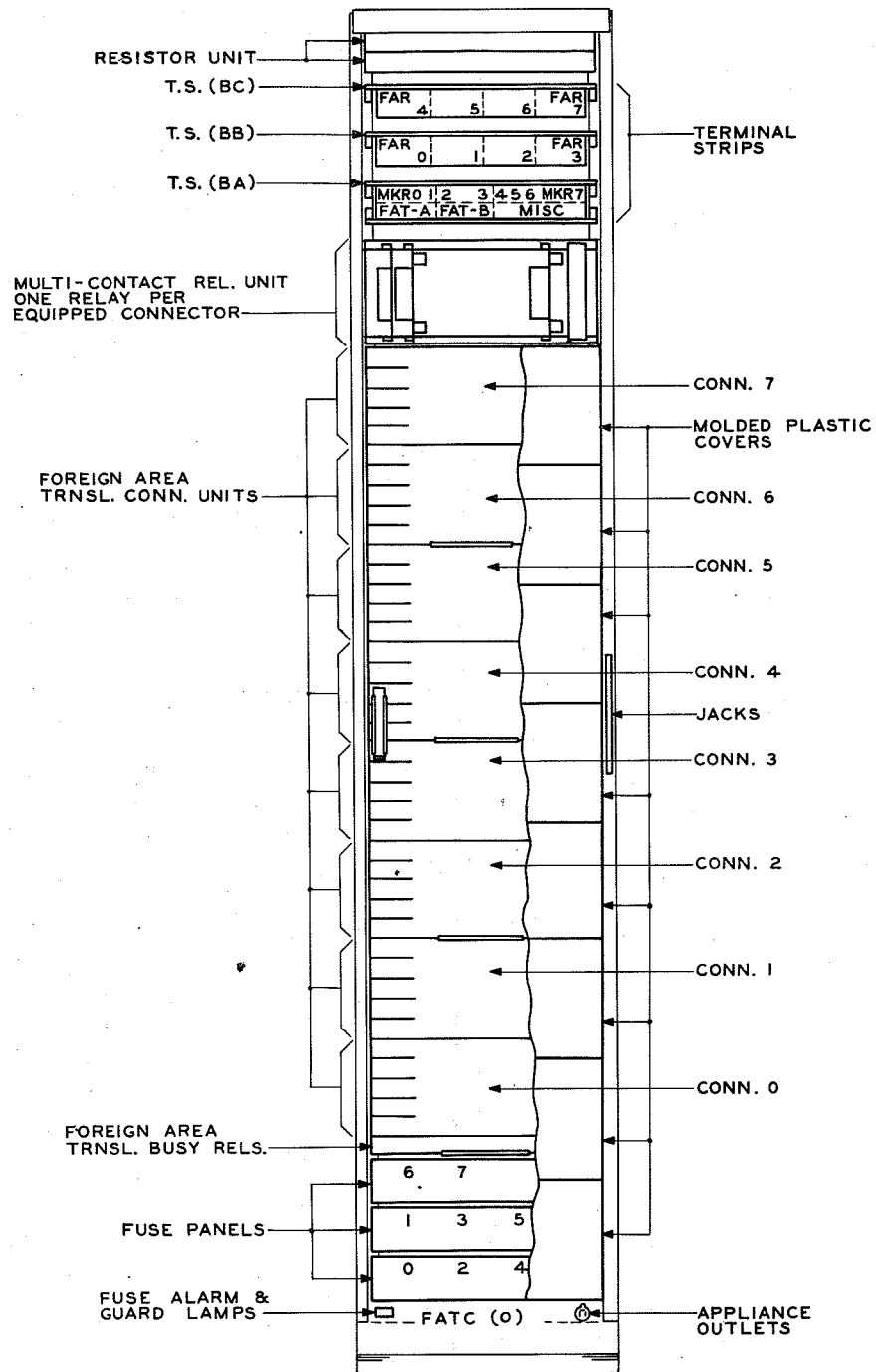

FIG. 28 - FOREIGN AREA TRANSLATOR CONNECTOR FRAME

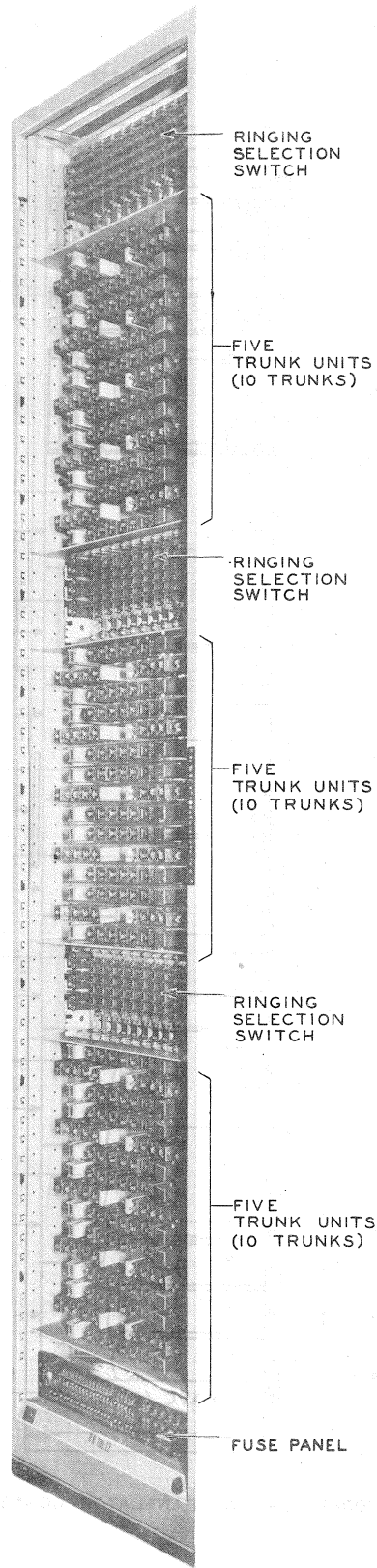

FIG. 29  
TRUNK RELAY RACK

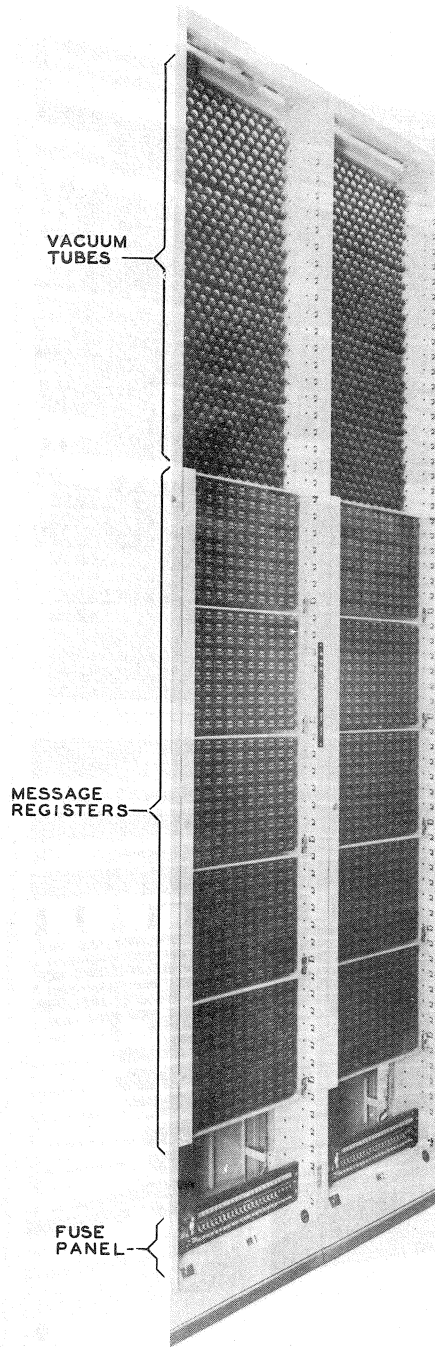

FIG. 30 - MESSAGE REGISTER FRAMES



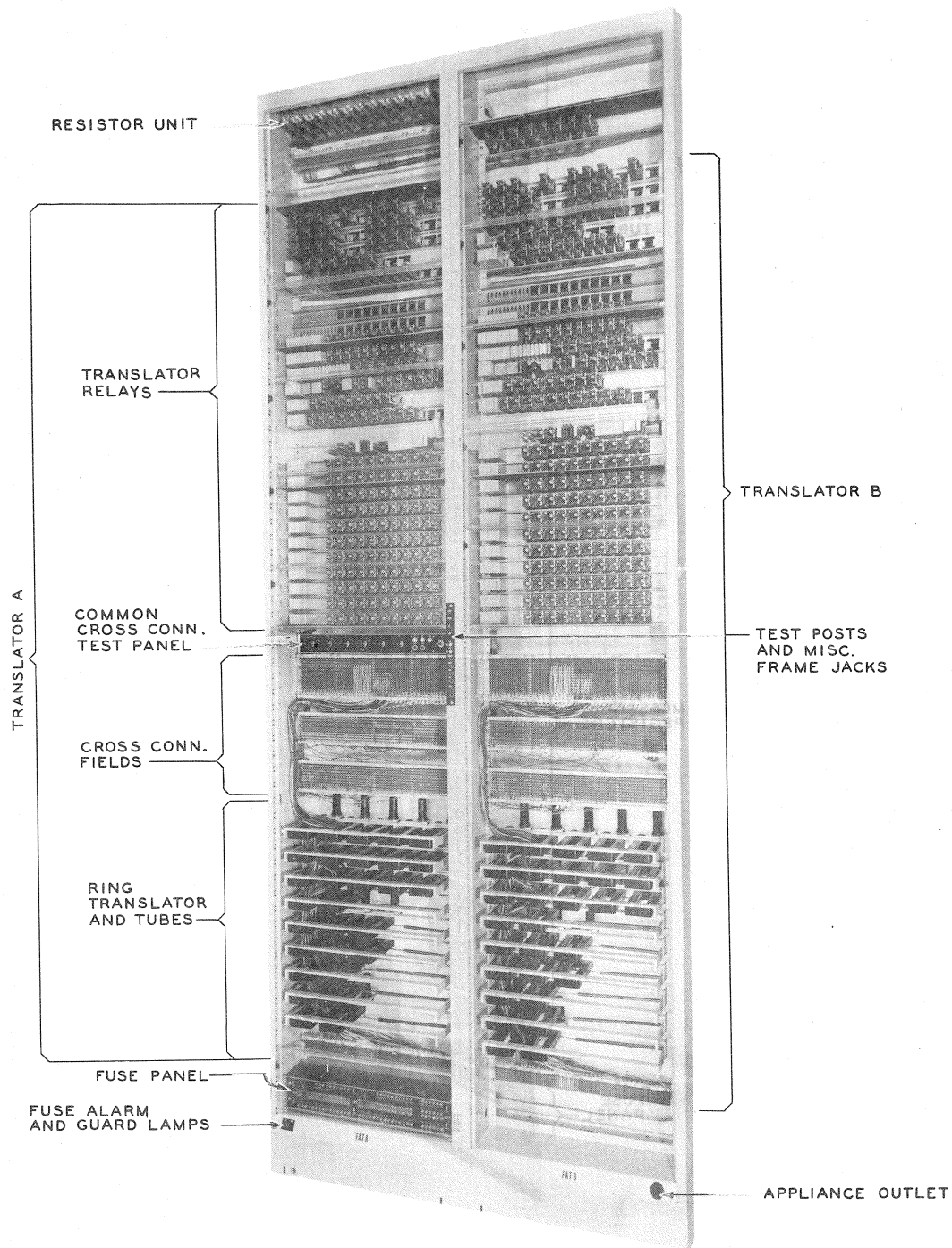
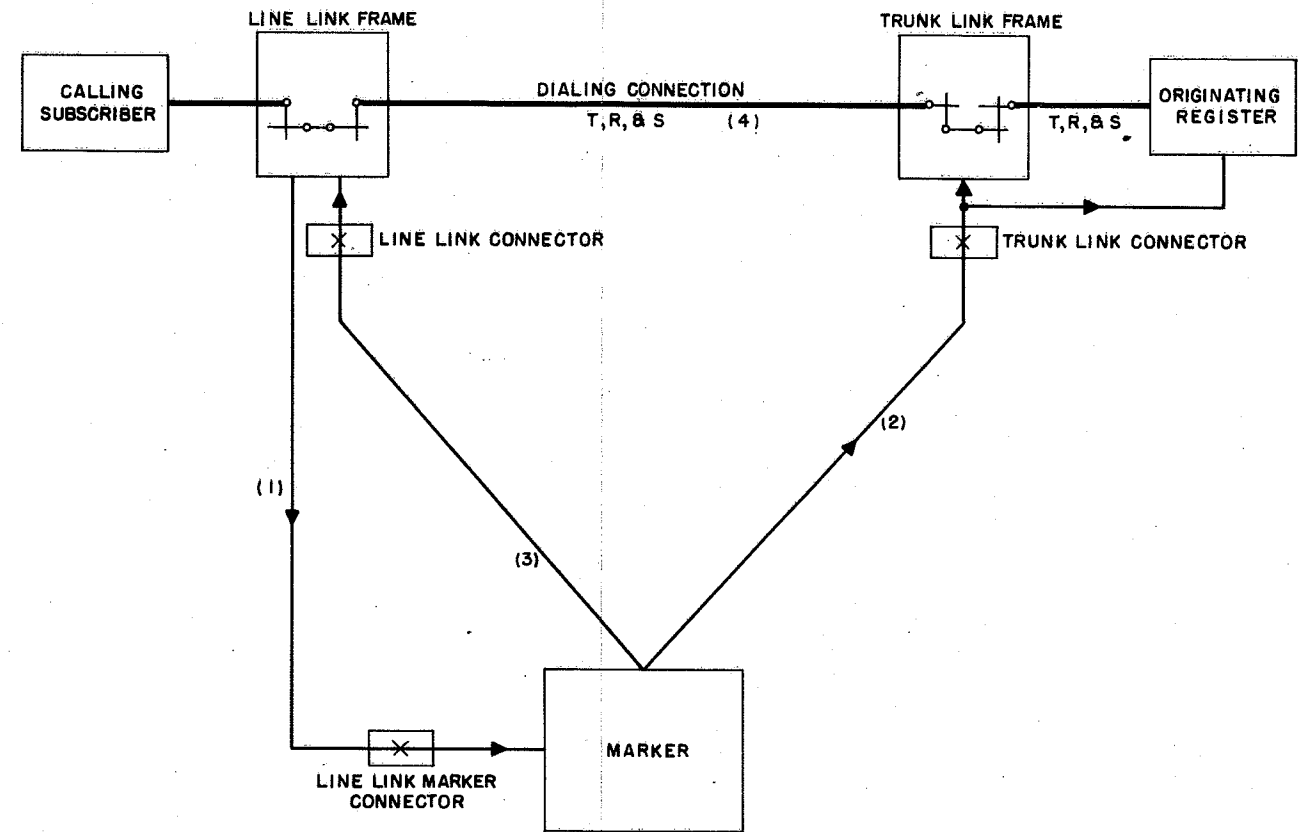

FIG. 31 - FOREIGN AREA TRANSLATOR FRAME



NOTES:  
1. PARENTHETICAL NUMBERS INDICATE ORDER OF CONNECTIONS.  
2. ARROWS INDICATE DIRECTION OF CONNECTIONS.

FIG. 37  
ESTABLISHING DIALING CONNECTION

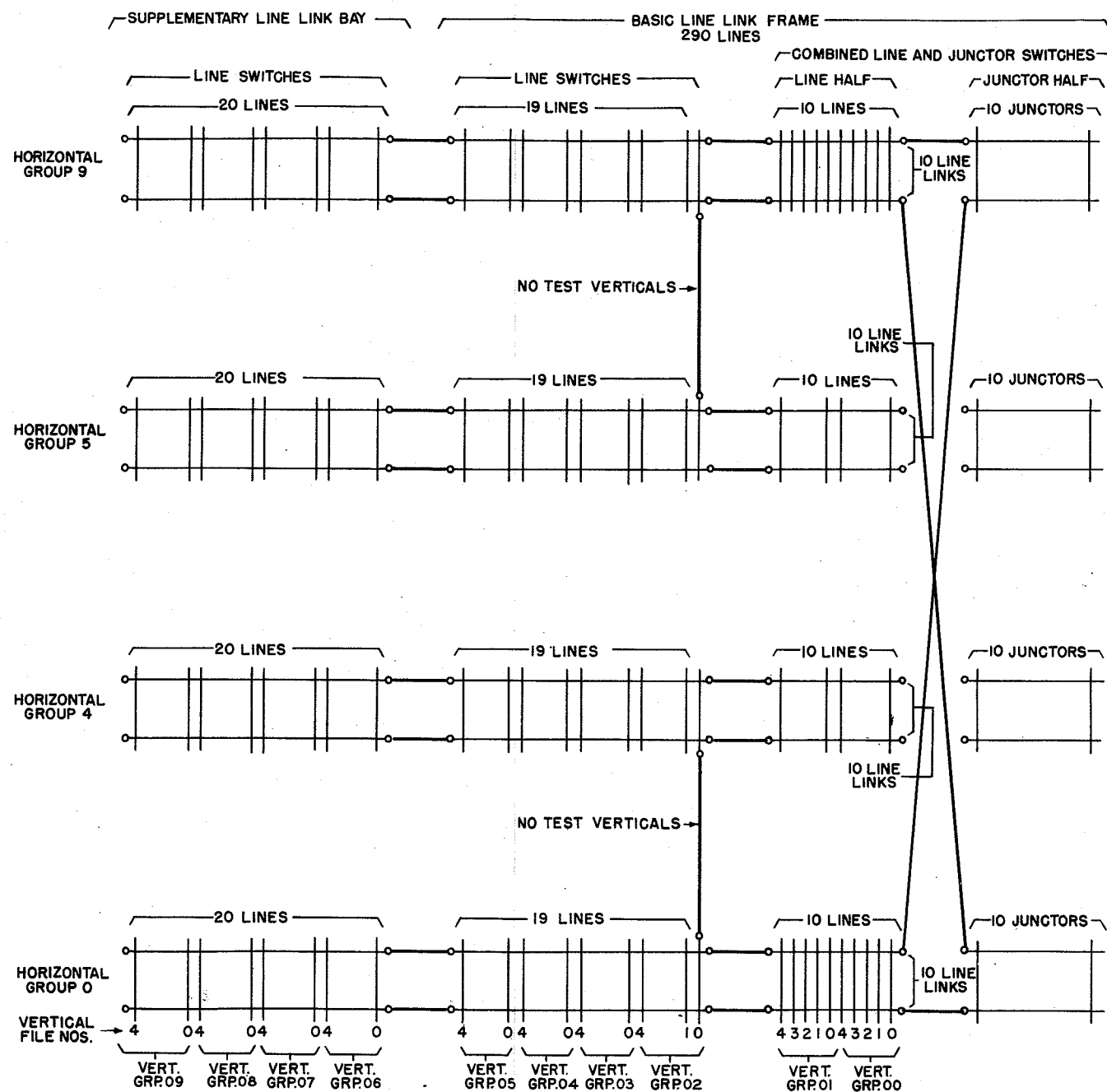
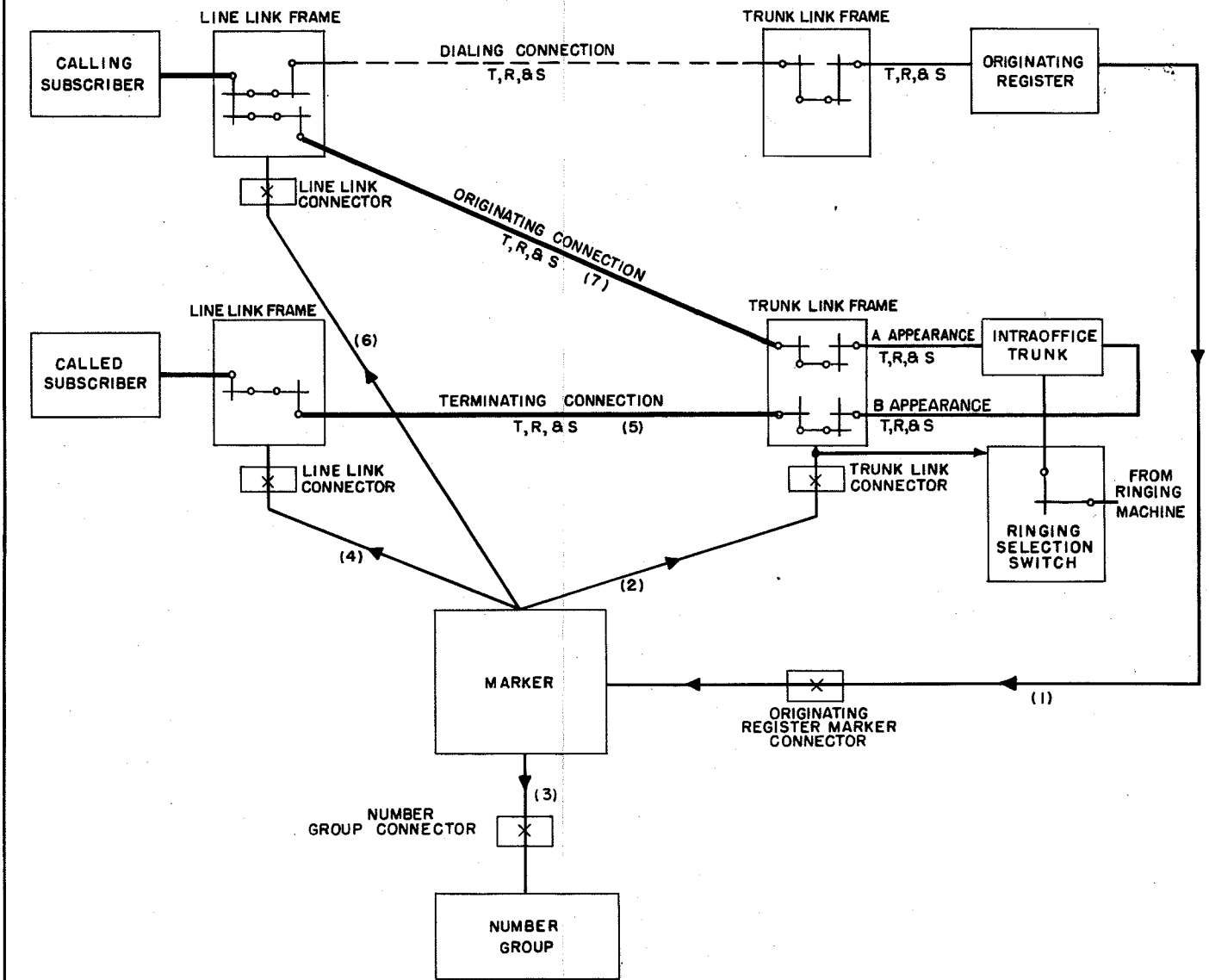
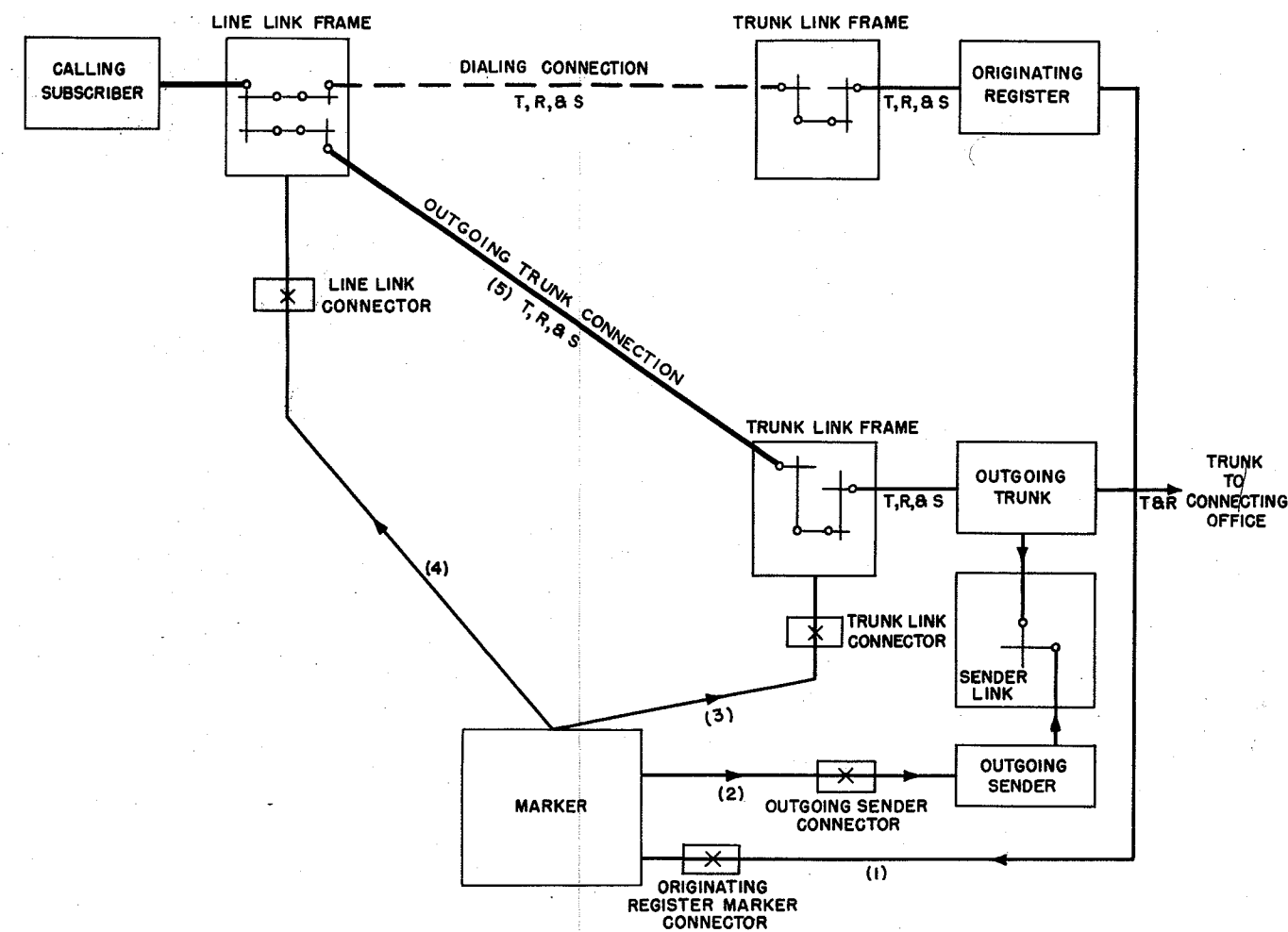

FIG. 38  
 LINE LINK FRAME SCHEMATIC (WIRING SIDE)  
 FRAME ARRANGED FOR 490 LINES



NOTES:  
 1. PARENTHETICAL NUMBERS INDICATE ORDER OF CONNECTIONS.  
 2. ARROWS INDICATE DIRECTION OF CONNECTIONS.

FIG. 39  
 ESTABLISHING INTRAOFFICE TRUNK CONNECTION



NOTES:  
 1. PARENTHETICAL NUMBERS INDICATE ORDER OF CONNECTIONS.  
 2. ARROWS INDICATE DIRECTION OF CONNECTIONS.

FIG. 40  
 ESTABLISHING OUTGOING TRUNK CONNECTION

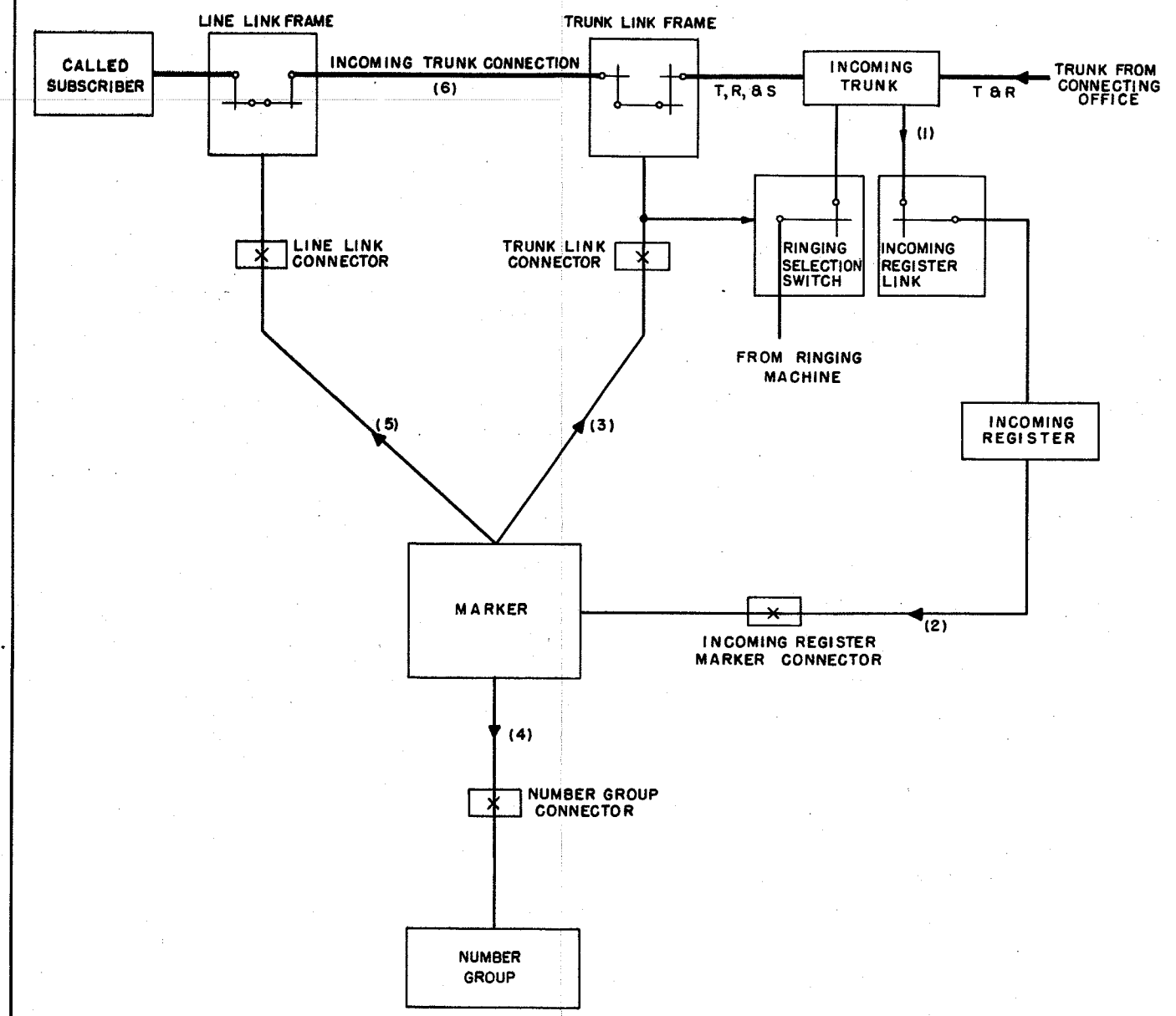

NOTES:  
 1. PARENTHETICAL NUMBERS INDICATE ORDER OF CONNECTIONS.  
 2. ARROWS INDICATE DIRECTION OF CONNECTIONS.

FIG. 41  
 ESTABLISHING INCOMING TRUNK CONNECTION

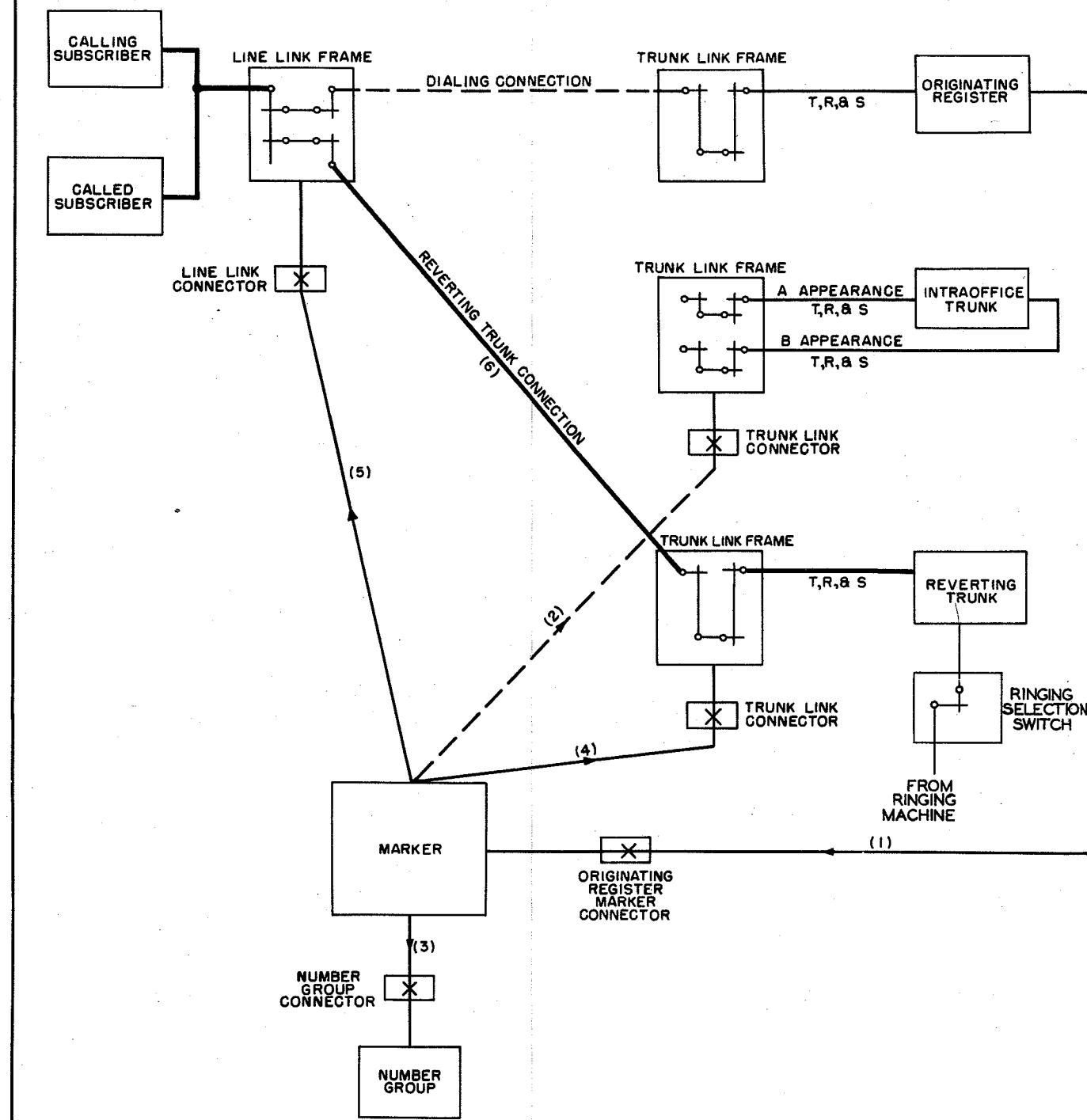

NOTES:  
 1. PARENTHETICAL NUMBERS INDICATE ORDER OF CONNECTIONS.  
 2. ARROWS INDICATE DIRECTION OF CONNECTIONS.

FIG. 42

ESTABLISHING REVERTING TRUNK CONNECTION

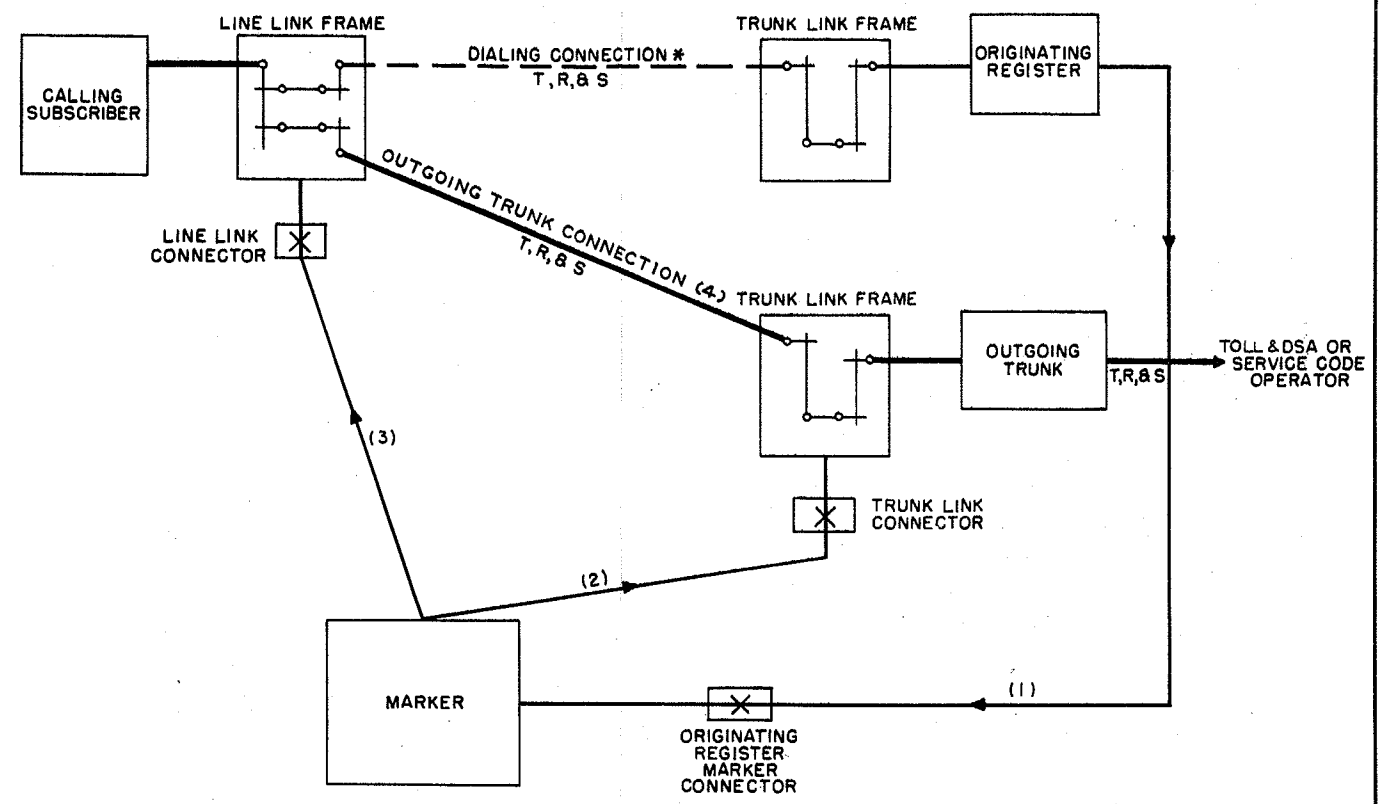

- NOTES:
1. PARENTHETICAL NUMBERS INDICATE ORDER OF CONNECTIONS.
  2. ARROWS INDICATE DIRECTION OF CONNECTIONS.
  3. \*MANUAL SUBSCRIBERS DO NOT RECEIVE DIAL TONE.

FIG. 43  
 ESTABLISHING TOLL AND DSA OPERATOR  
 SERVICE CODE, OR  
 MANUAL TRUNK CONNECTION



ES-454530

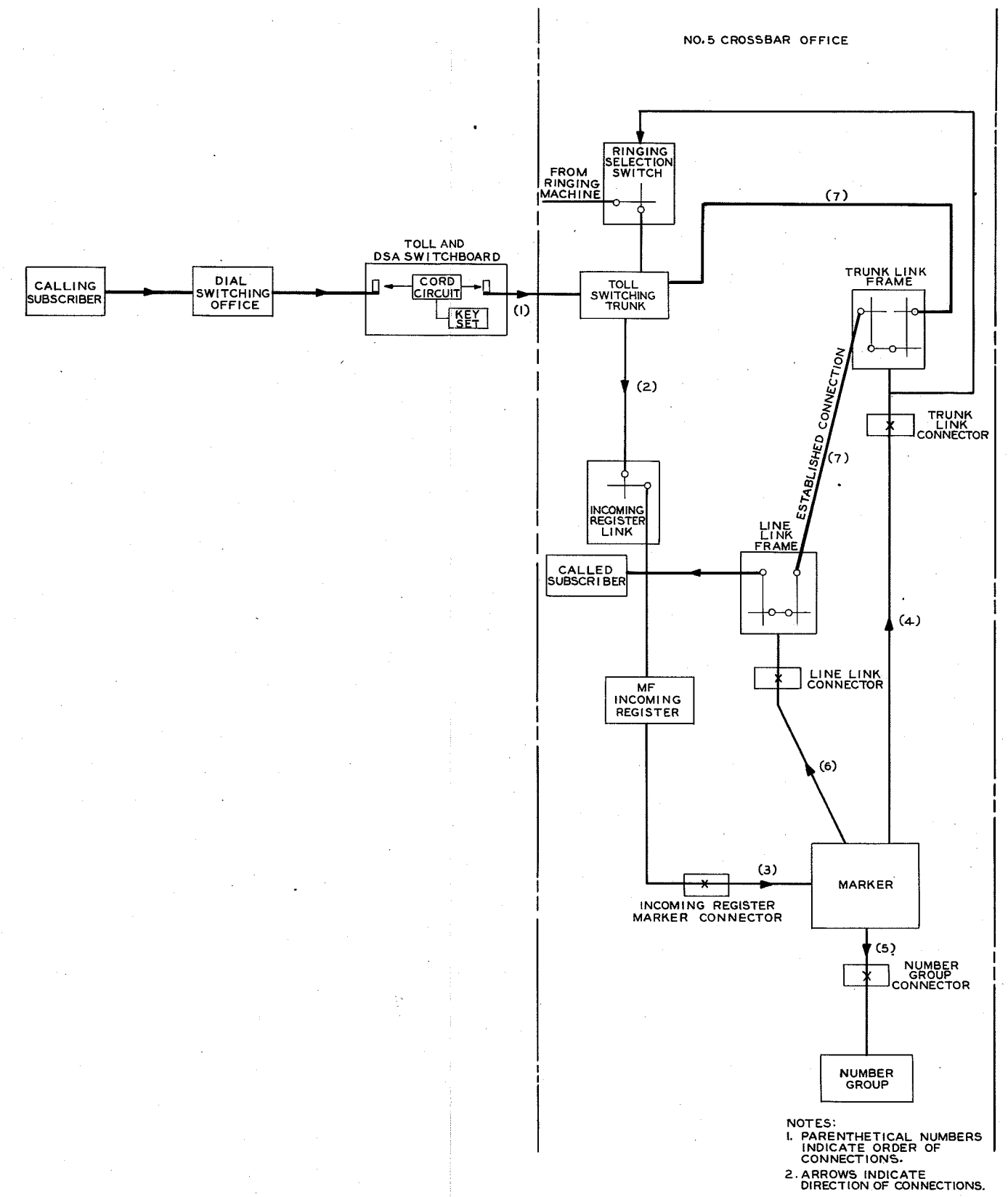

NOTES:  
 1. PARENTHEICAL NUMBERS INDICATE ORDER OF CONNECTIONS.  
 2. ARROWS INDICATE DIRECTION OF CONNECTIONS.

FIG. 47  
 CALL FROM TOLL AND DSA SWITCHBOARD  
 COMPLETED TO NO. 5 CROSSBAR SUBSCRIBER

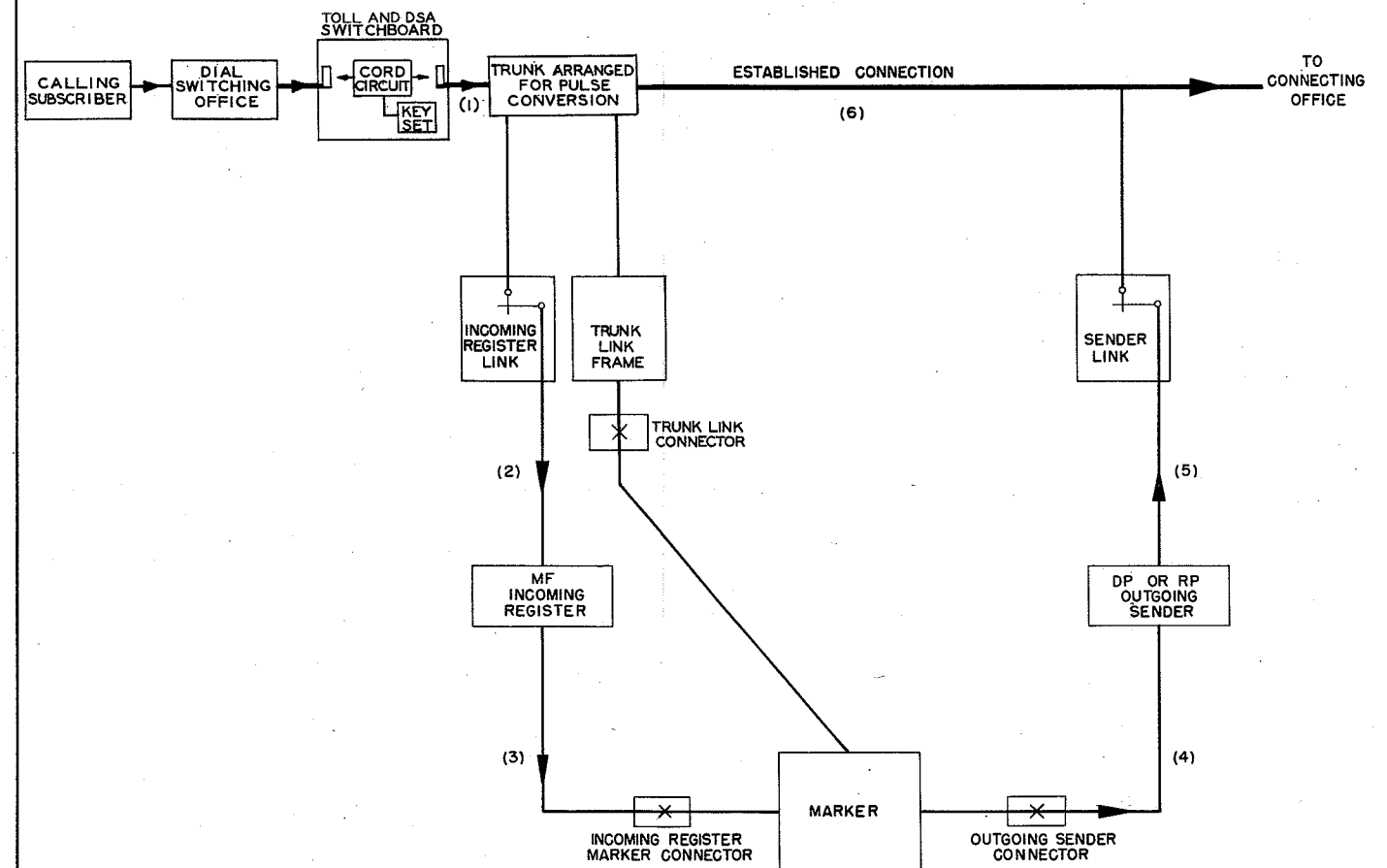

NOTES:  
 1. PARENTHETICAL NUMBERS INDICATE ORDER OF CONNECTIONS.  
 2. ARROWS INDICATE DIRECTION OF CONNECTIONS.

FIG. 48  
 OUTGOING CALL FROM TOLL AND DSA SWITCHBOARD  
 (PULSE CONVERSION)

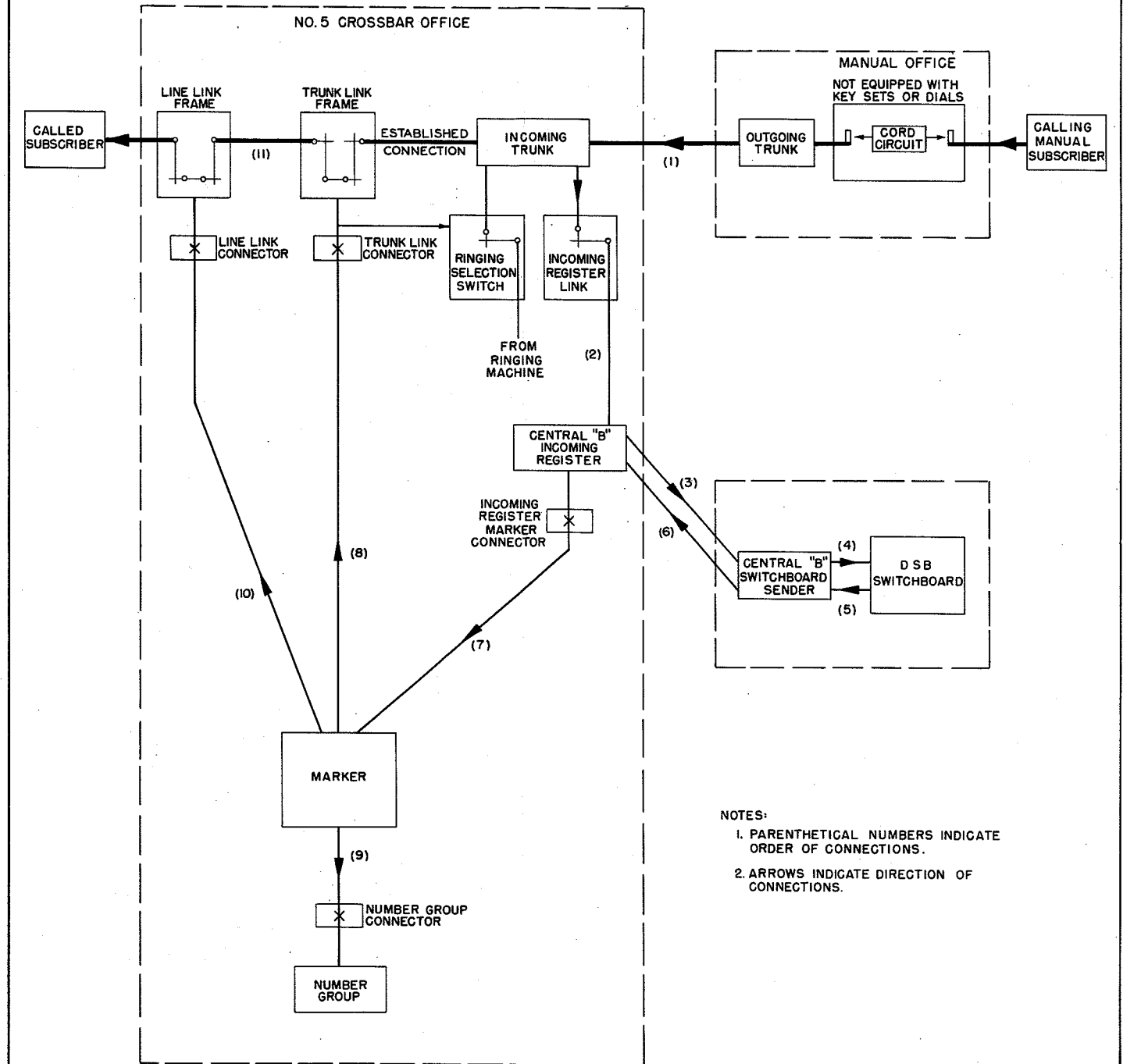

NOTES:  
 1. PARENTHEICAL NUMBERS INDICATE ORDER OF CONNECTIONS.  
 2. ARROWS INDICATE DIRECTION OF CONNECTIONS.

FIG. 49  
 OPERATION OF NO. 5 CROSSBAR  
 OFFICE ASSOCIATED WITH DSB SWITCHBOARD

TERMINATING POINTS (Z)

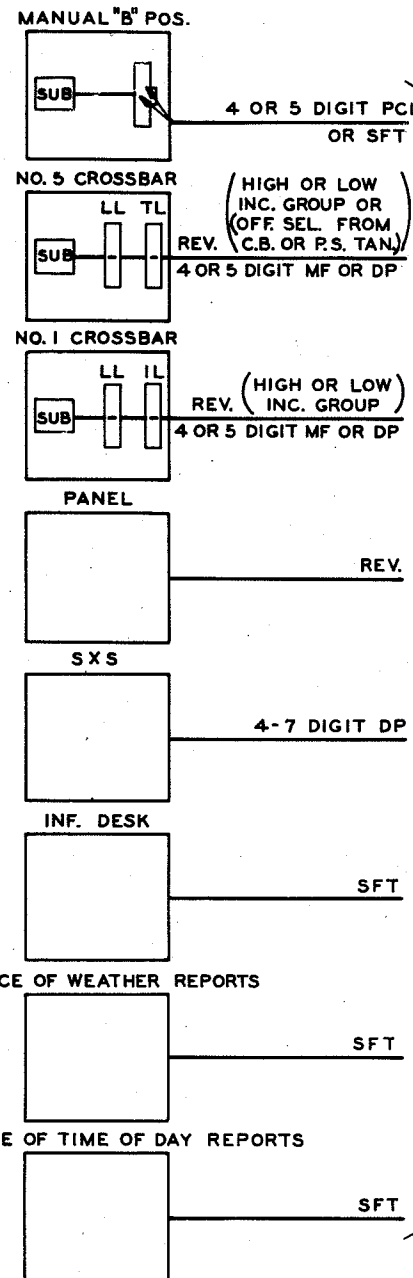

SUCCEEDING TANDEM POINT

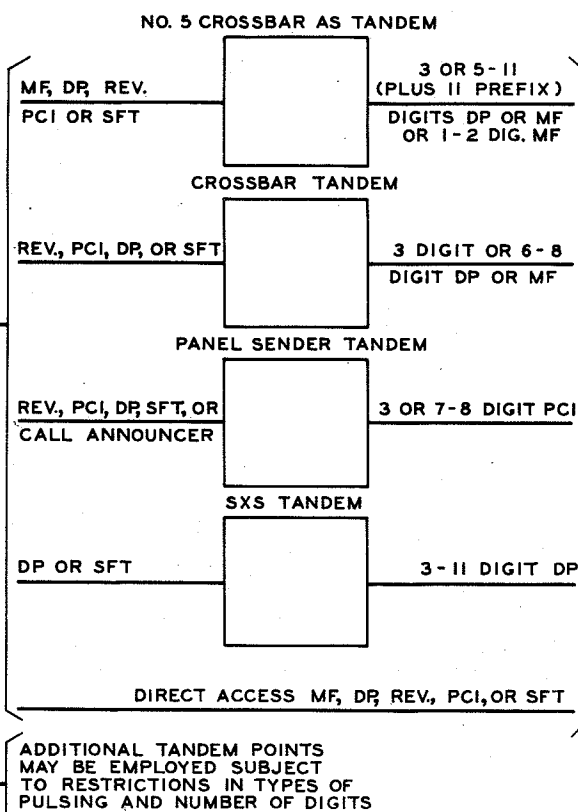

NO. 5 CROSSBAR OFFICE (TANDEM CENTER)(Y)

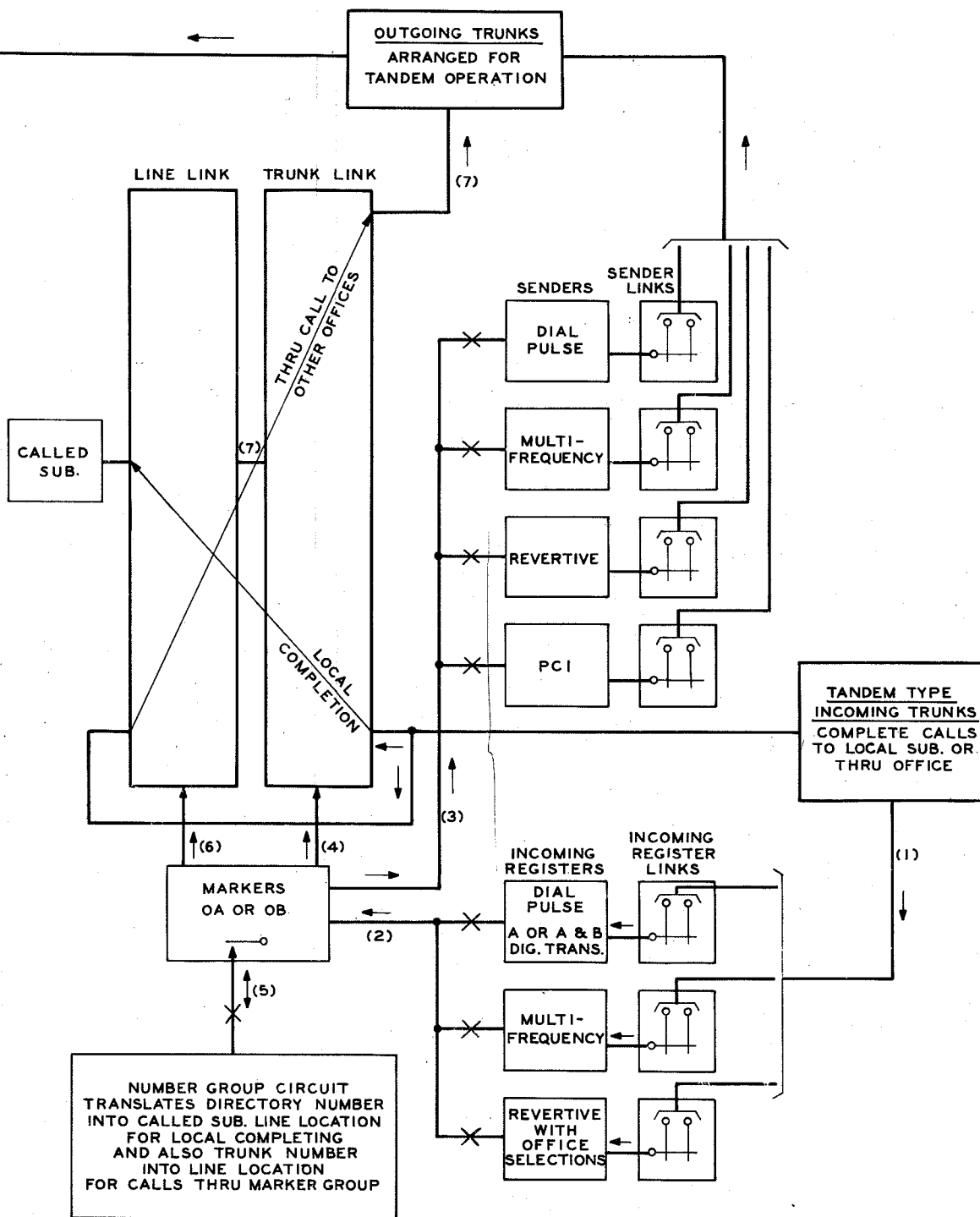

ORIGINATING POINTS (X)

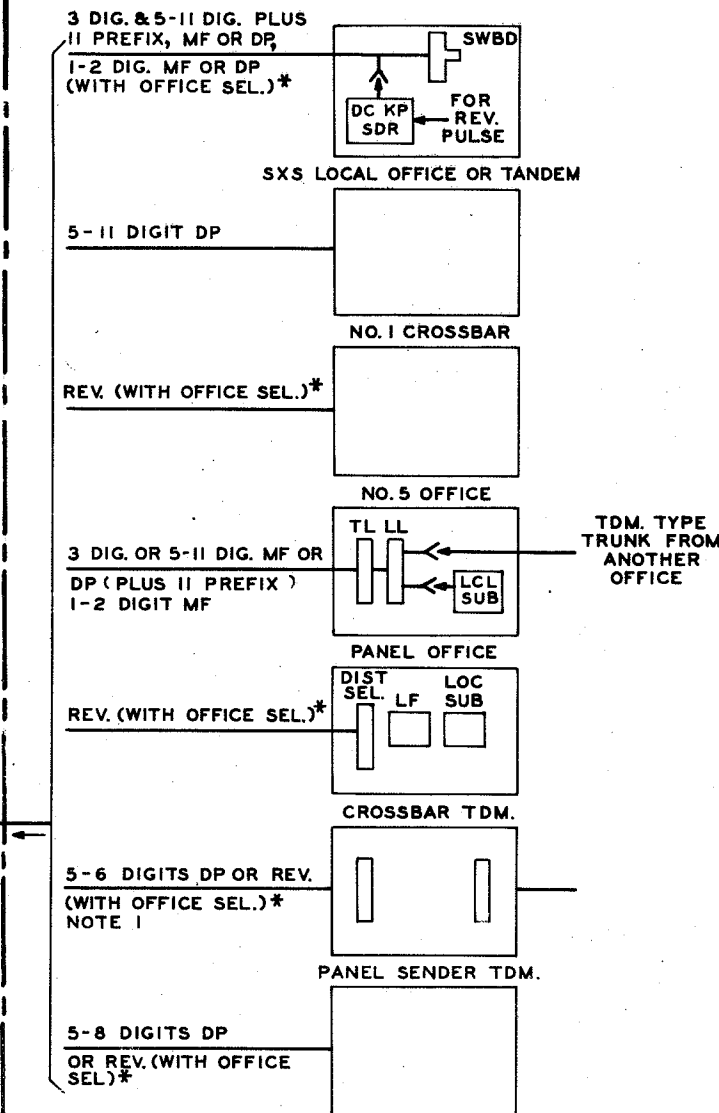

NOTES:  
I. IN CROSSBAR TANDEM, ONLY SENDERS INCOMING FROM DIAL PULSE AND MF CAN SEND OFFICE SELECTIONS WITH REVERTIVE PULSES

\* CAN BE EMPLOYED IF NO. 5 MARKER GROUP EQUIPPED WITH TANDEM TYPE REVERTIVE INCOMING REGISTER

FIG. 50- TANDEM CENTER SWITCHING COMBINED WITH LOCAL COMPLETION TO SUBSCRIBERS IN THE SAME MARKER GROUP

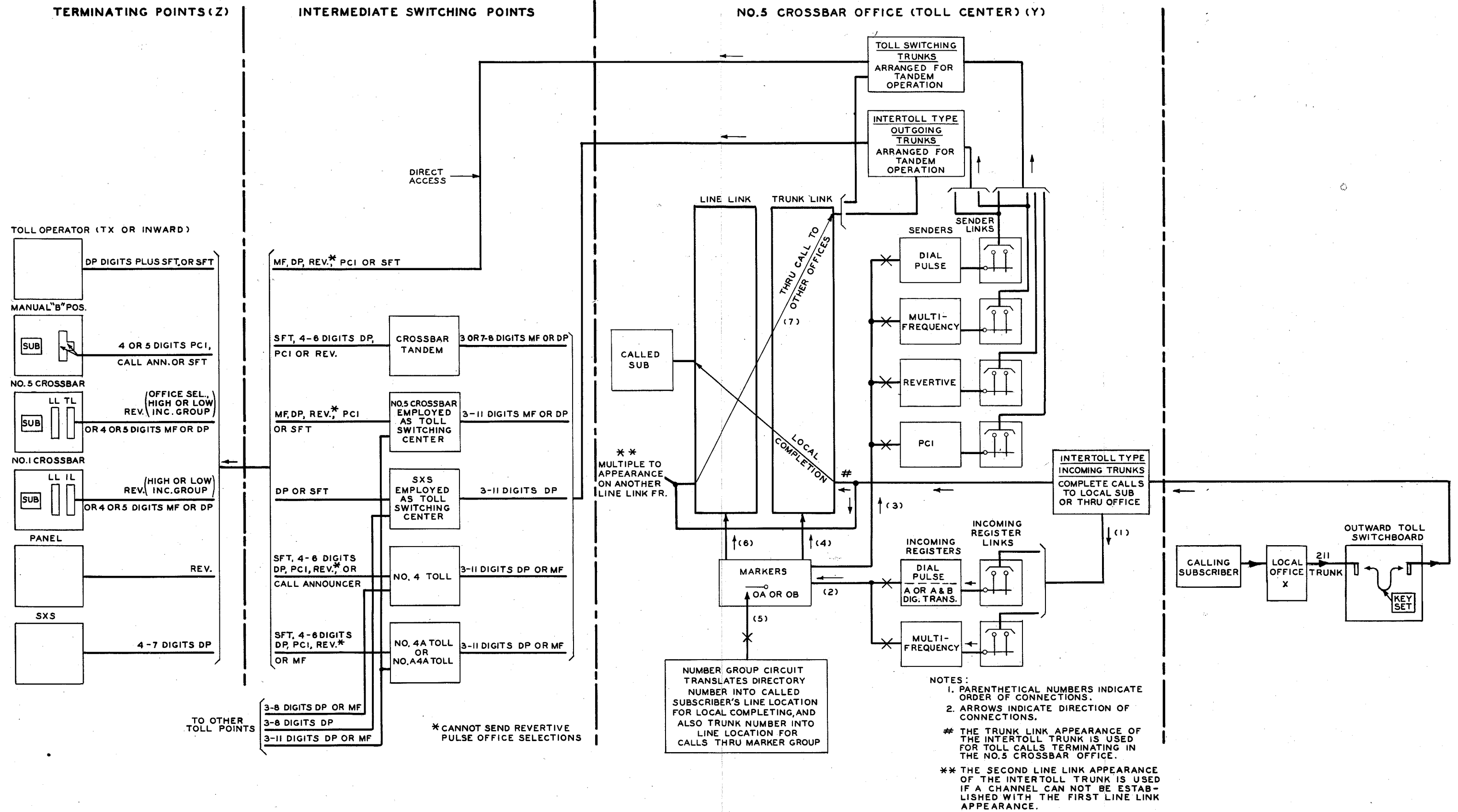

FIG. 51 - TOLL CENTER SWITCHING COMBINED WITH LOCAL COMPLETION TO SUBSCRIBERS IN THE SAME MARKER GROUP

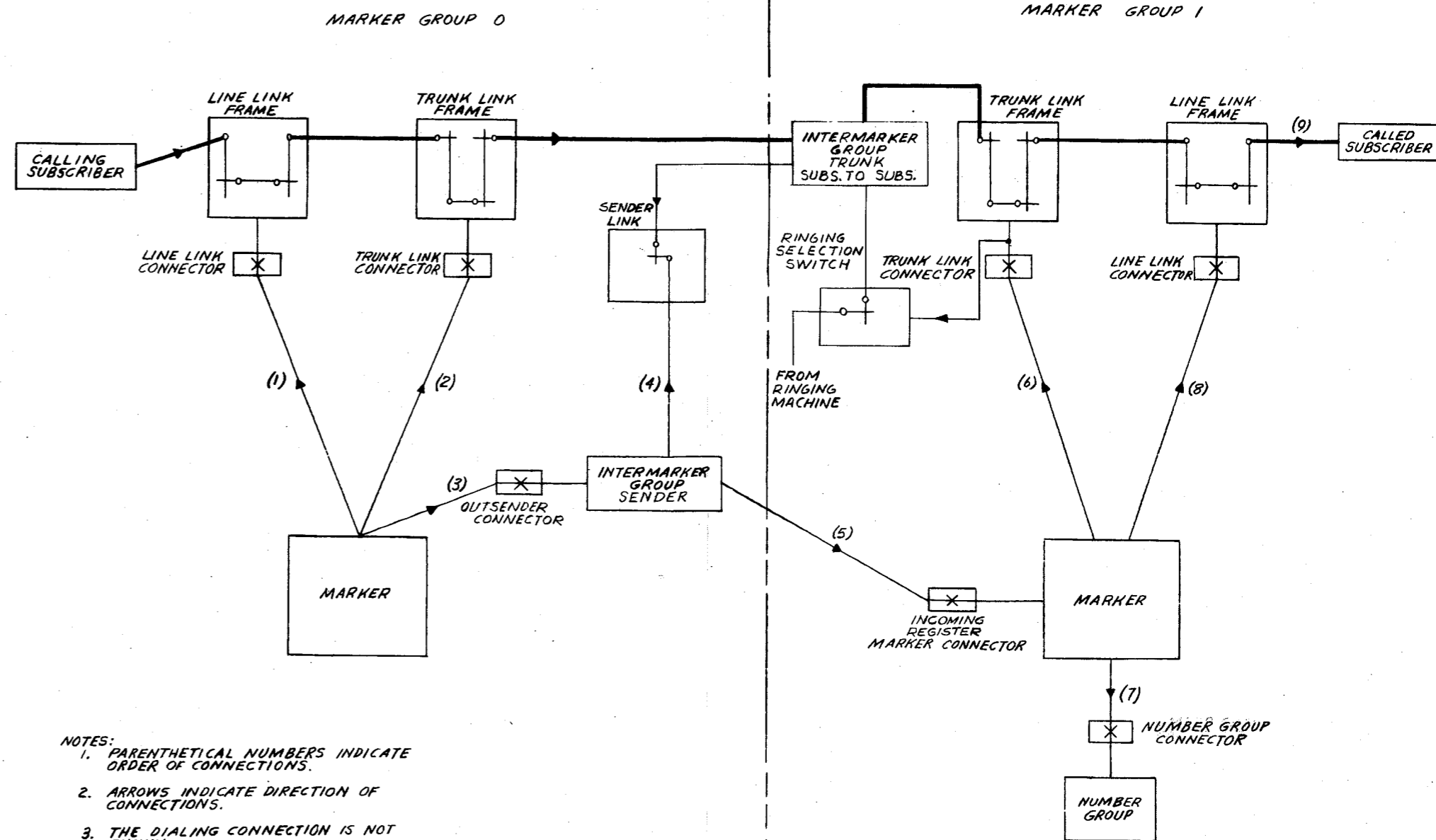
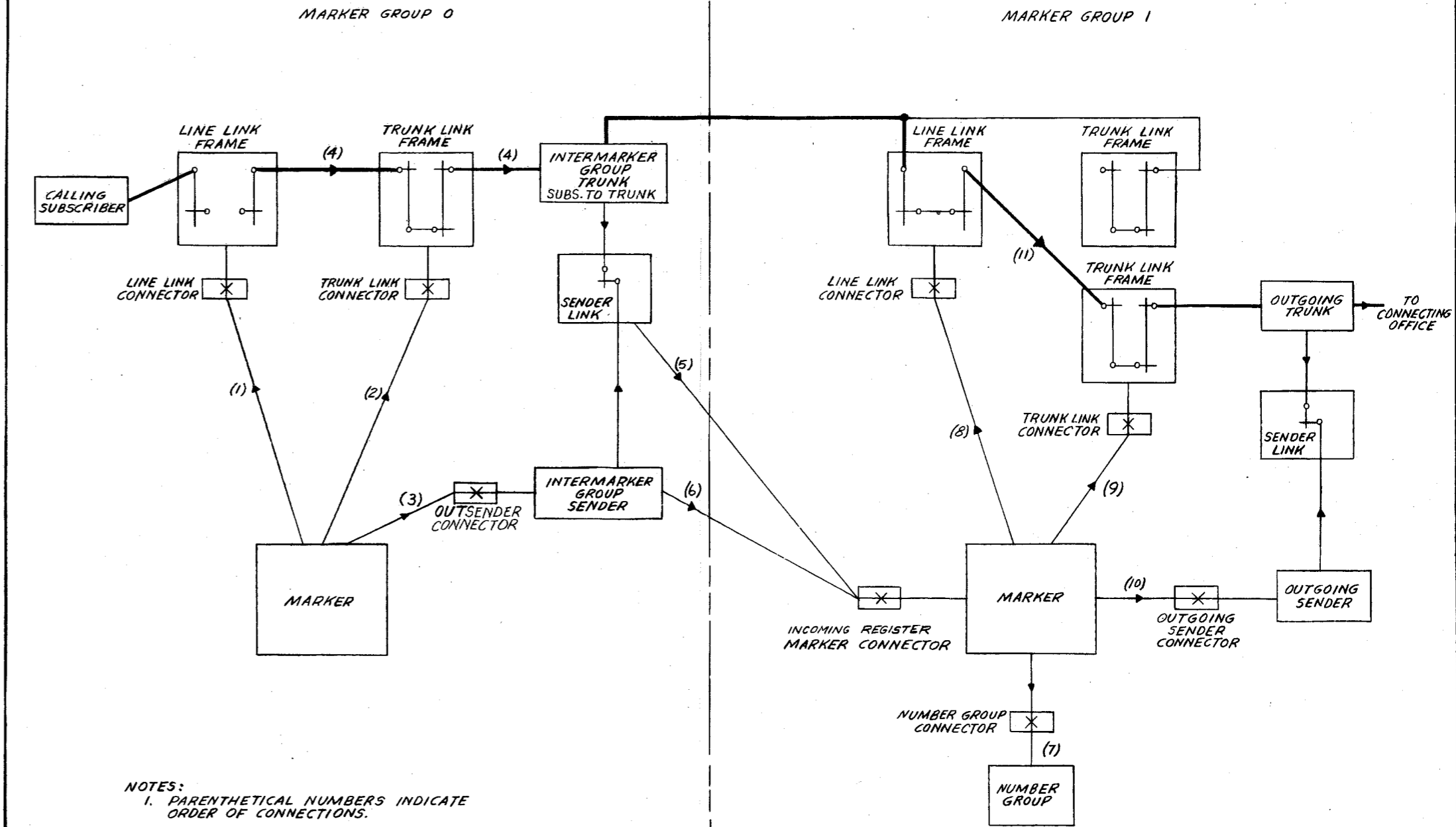
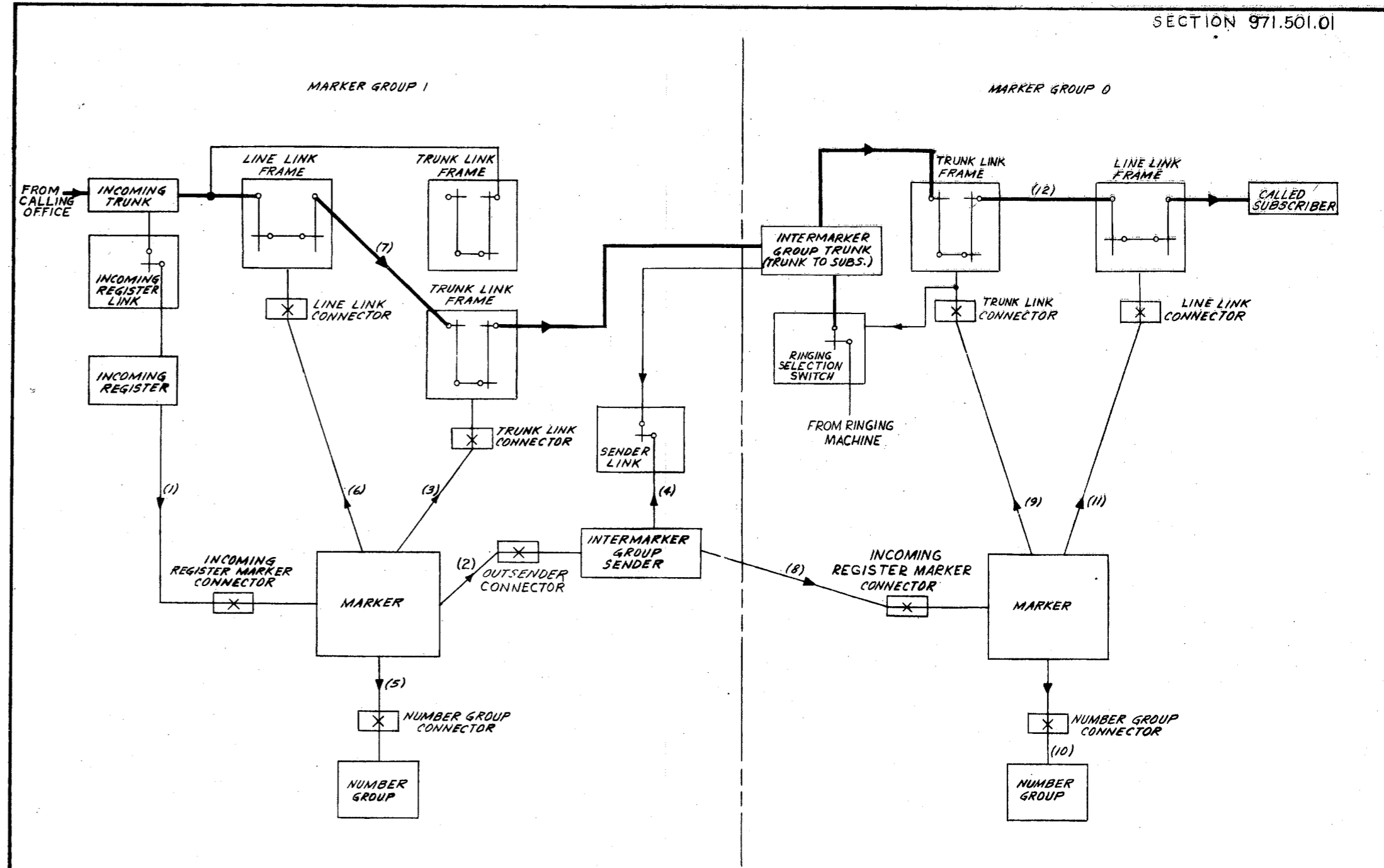

FIG. 52  
INTERMARKER GROUP TRUNK CONNECTION  
SUBSCRIBER TO SUBSCRIBER



- NOTES:
1. PARENTHETICAL NUMBERS INDICATE ORDER OF CONNECTIONS.
  2. ARROWS INDICATE DIRECTION OF CONNECTIONS.
  3. THE DIALING CONNECTION IS NOT SHOWN.

FIG. 53  
INTERMARKER GROUP TRUNK CONNECTION  
SUBSCRIBER TO TRUNK



- NOTES:
1. PARENTHETICAL NUMBERS INDICATE ORDER OF CONNECTIONS.
  2. ARROWS INDICATE DIRECTION OF CONNECTIONS.
  3. THE DIALING CONNECTION IS NOT SHOWN.

FIG. 54  
INTERMARKER GROUP TRUNK CONNECTION  
TRUNK TO SUBSCRIBER



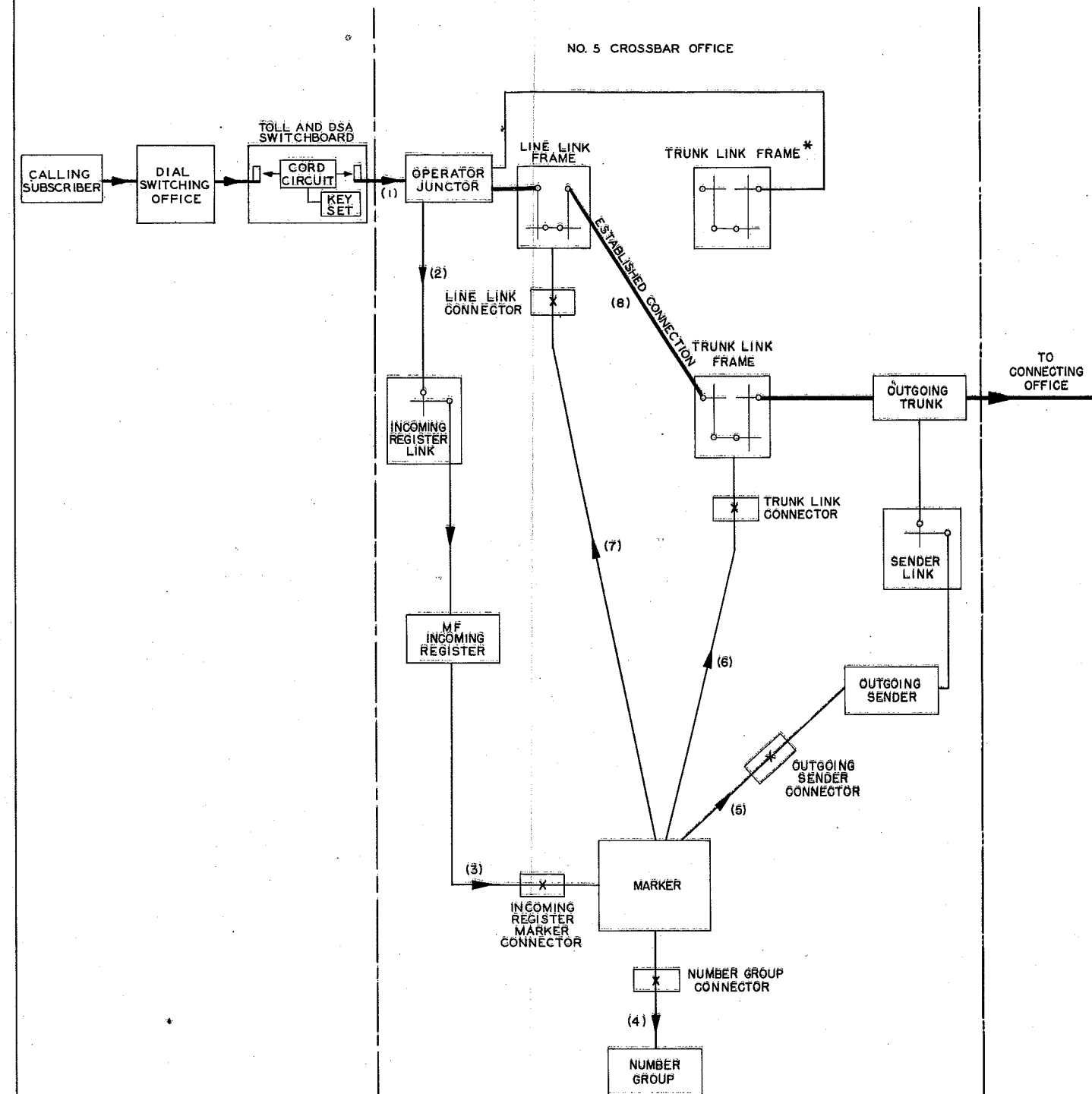

\* THE TRUNK LINK APPEARANCE OF THE TRUNK IS USED TO RETURN OVERFLOW SIGNAL TO THE DSA OPERATOR.

NOTES:  
 1. PARENTHEetical NUMBERS INDICATE ORDER OF CONNECTIONS.  
 2. ARROWS INDICATE DIRECTION OF CONNECTIONS.

FIG. 55  
 CALL FROM A TOLL AND DSA SWITCHBOARD ASSOCIATED WITH A NO. 5 CROSSBAR OFFICE TO A CONNECTING OFFICE

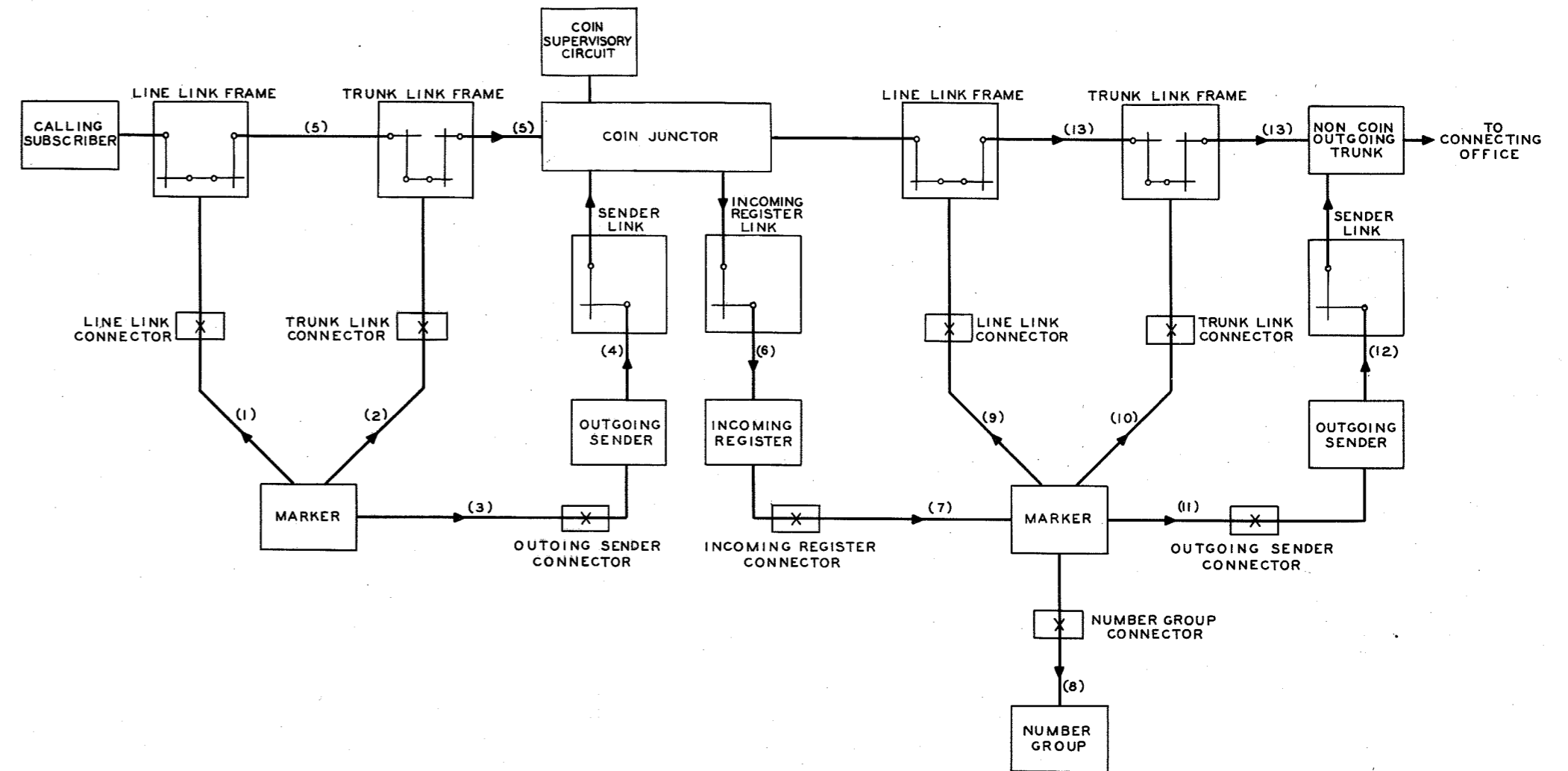
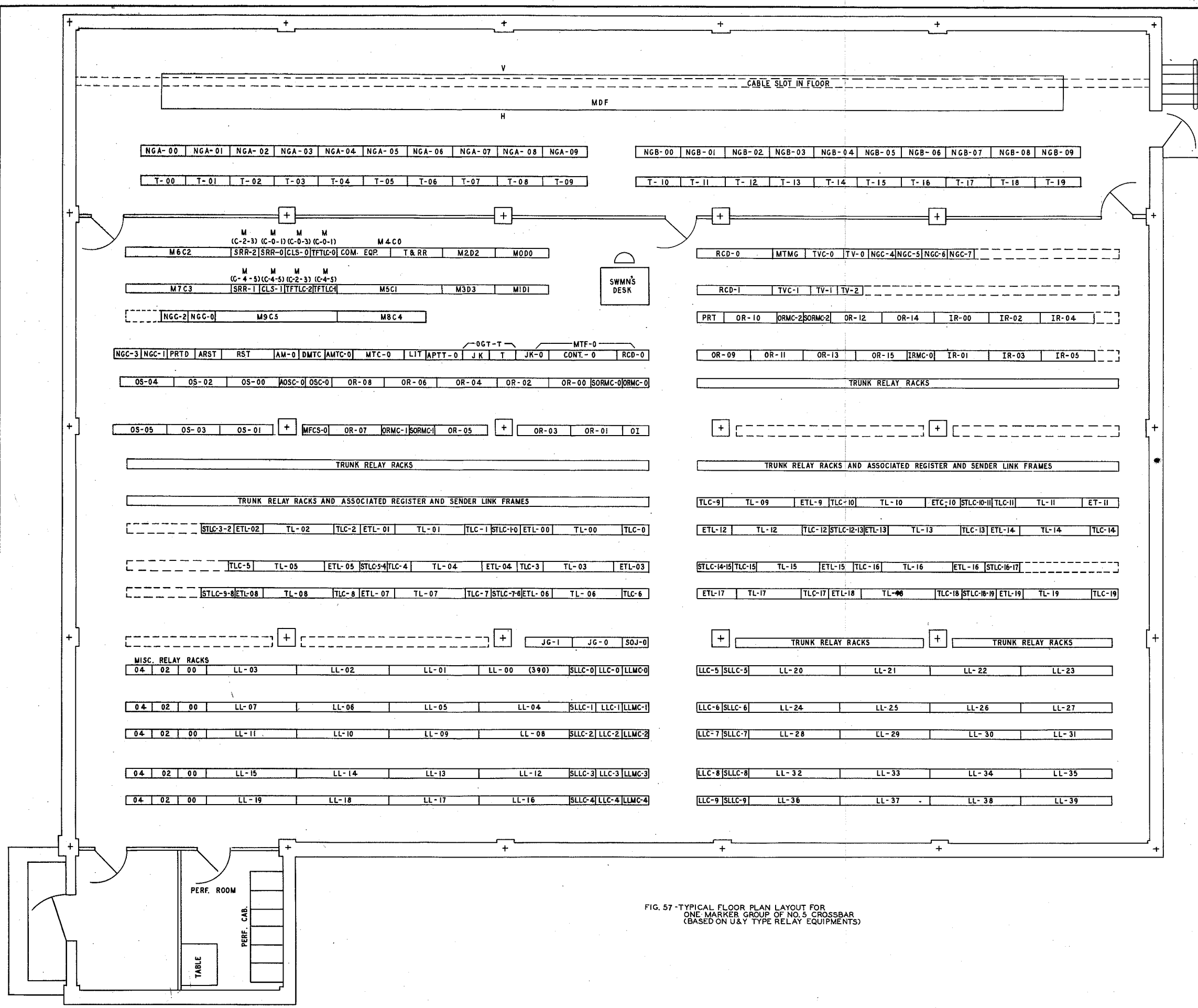

FIG. 56  
COIN JUNCTOR OPERATION



- DESIGNATION REFERENCE FUNCTIONAL MEANING
- AM - AUTOMATIC MONITOR
  - AMTC - AUXILIARY MASTER TEST CONNECTOR (AMA)
  - AOSC - AUXILIARY OUTGOING SENDER CONNECTOR
  - APTT - AUTOMATIC PROGRESSION TRUNK TEST
  - ARST - AUXILIARY REGISTER AND SENDER TEST
- 
- COM EQPT - COMMON EQUIPMENT (MARKER)
  - CSL - COIN SUPERVISORY LINK
- 
- DMTC - MASTER TEST CONNECTOR FOR DIAL TONE MARKERS
- 
- ETL - EXTENSION TRUNK LINK
- 
- IR - INCOMING REGISTER
  - IRL - INCOMING REGISTER LINK
  - IRMC - INCOMING REGISTER MARKER CONNECTOR
- 
- JG - JUNCTOR GROUPING FRAME
  - JK - JACK BAY (MASTER TEST FRAME) AND (OUTGOING TRUNK TEST FRAME)
- 
- LIT - LINE INSULATION TEST
  - LL - LINE LINK
  - LLC - LINE LINK CONNECTOR
  - LLMC - LINE LINK MARKER CONNECTOR
- 
- M - MARKER
  - M-C - COMPLETING MARKER
  - M-D - DIAL TONE MARKER
  - M(-)CLS - CLASS OF SERVICE
  - M(-)SRR - SUPPLEMENTARY ROUTE RELAY
  - M(-)FTLC - TRUNK FRAME TEST LEAD CONNECTOR
  - MDF - MAIN DISTRIBUTING FRAME
  - MFC5 - MULTI-FREQUENCY CURRENT SUPPLY
- 
- MTC - MASTER TEST CONNECTOR FOR COMPLETING MARKERS
  - MTF - MASTER TEST FRAME CONTROL
  - MTMG - MASTER TIMING (AMA)
- 
- NG-A - NUMBER GROUP - OFFICE A
  - NG-B - NUMBER GROUP - OFFICE B
  - NGC - NUMBER GROUP CONNECTOR
- 
- OCTT - OUTGOING TRUNK TEST
  - OI - OFFICE INTERRUPTER
  - OR - ORIGINATING REGISTER
  - ORMC - ORIGINATING REGISTER MARKER CONNECTOR
  - OS - OUTGOING SENDER
  - O5C - OUTGOING SENDER CONNECTOR
  - OSL - OUTGOING SENDER LINK
- 
- PERF CAB - PERFORATOR CABINET (AMA)
  - PRTD - POWER, RINGING AND TONE DISTRIBUTING
  - PRT - PRETRANSLATOR
- 
- RST - REGISTER AND SENDER TEST
  - RCD - RECORDER (AMA)
  - RCDR - RECORDER (MASTER TEST FRAME)
  - RR - RELAY RACK
- 
- SLLC - SUPPLEMENTARY LINE LINK CONNECTOR
  - SOJ - SERVICE OBSERVING JACKS
  - STLC - SUPPLEMENTARY TRUNK LINK CONNECTOR
- 
- T - TRANSLATOR (AMA)
  - T & RR - TRANSLATOR AND ROUTE RELAY (MARKER)
  - TL - TRUNK LINK
  - TLC - TRUNK LINK CONNECTOR
  - TV - TRANSVERTER (AMA)
  - TVC - TRANSVERTER CONNECTOR (AMA)

FIG. 57 - TYPICAL FLOOR PLAN LAYOUT FOR ONE MARKER GROUP OF NO. 5 CROSSBAR (BASED ON U & Y TYPE RELAY EQUIPMENTS)

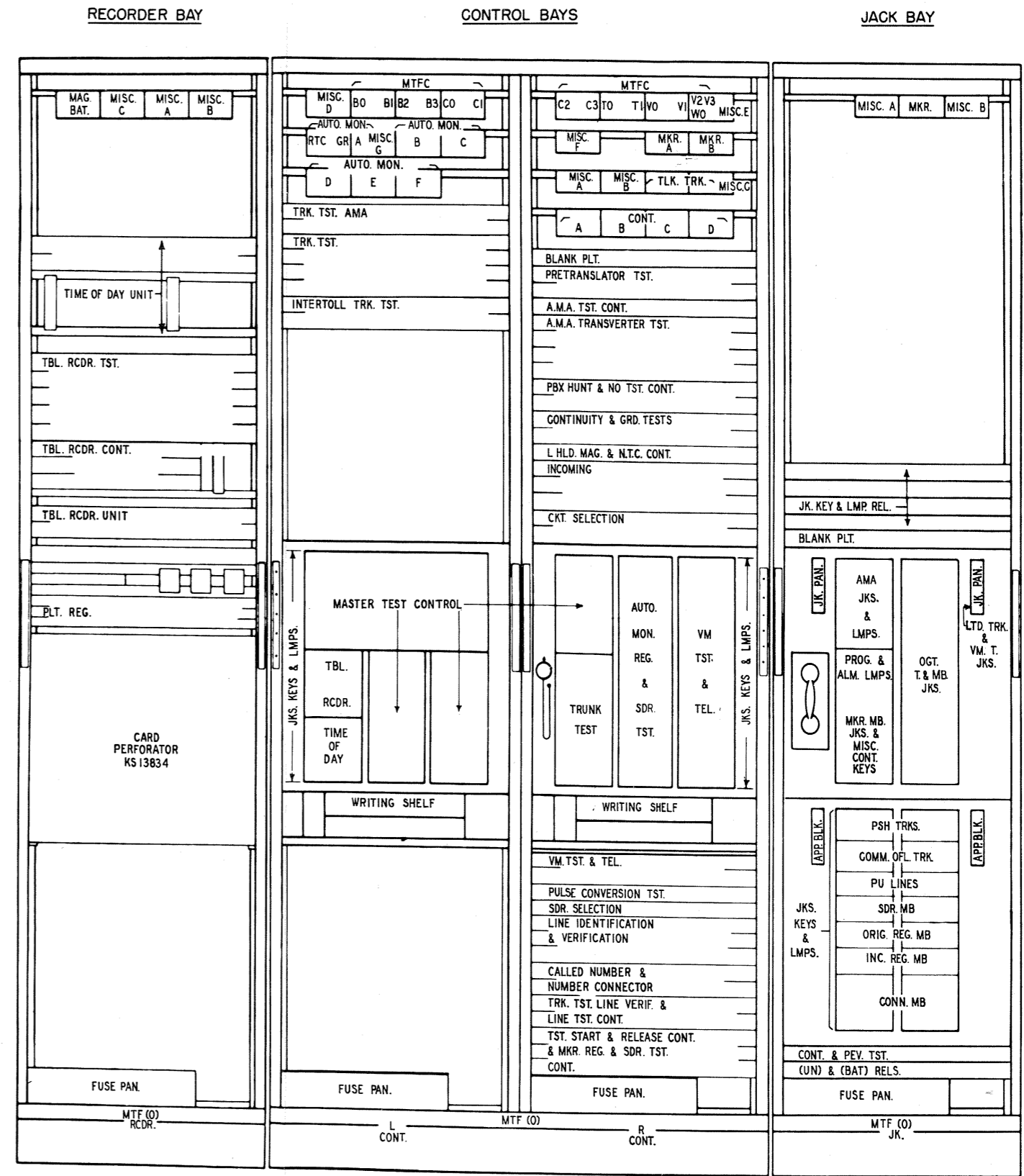
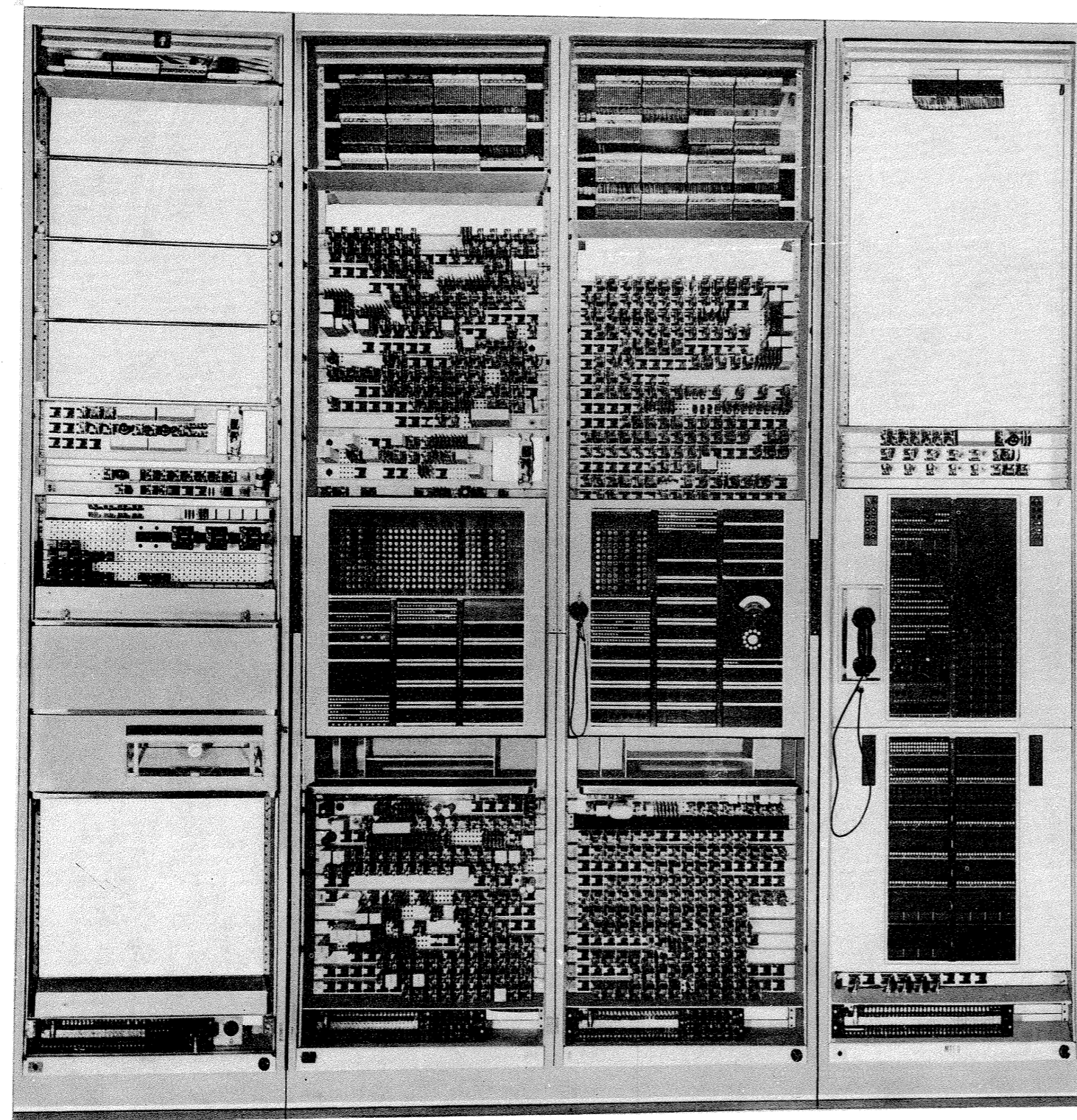
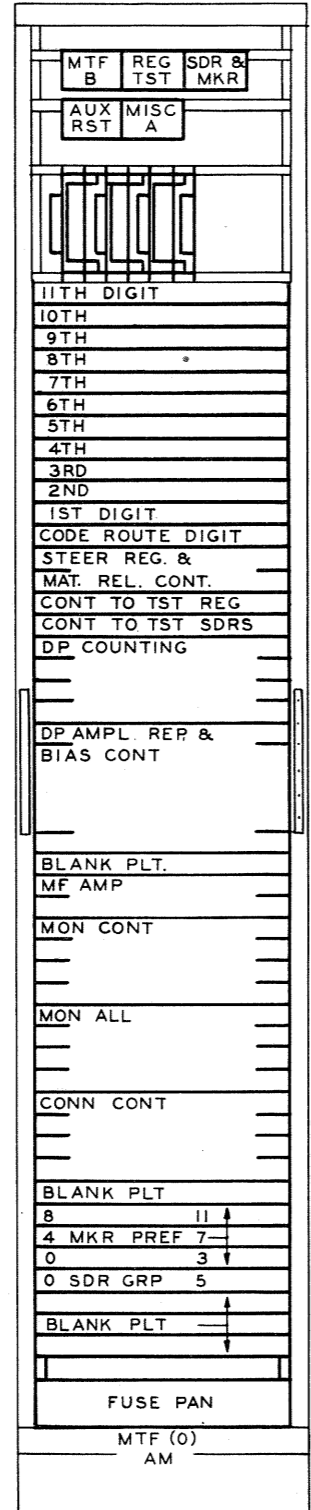
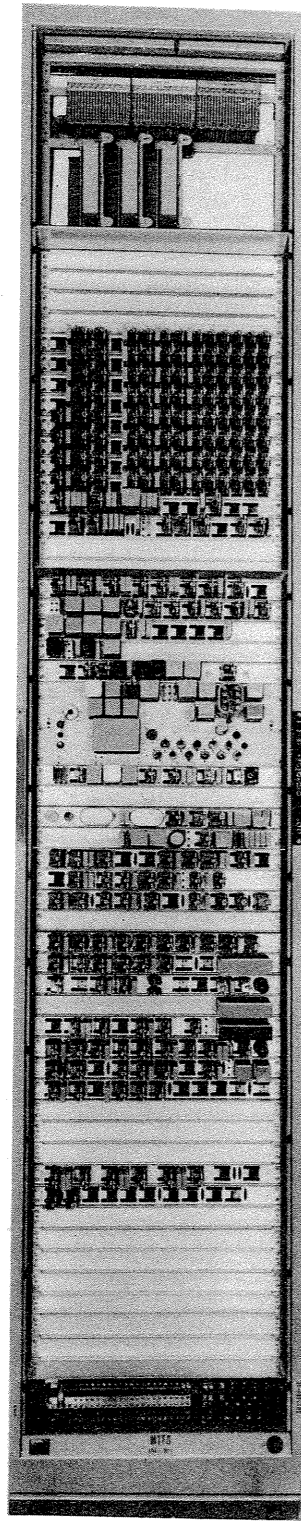
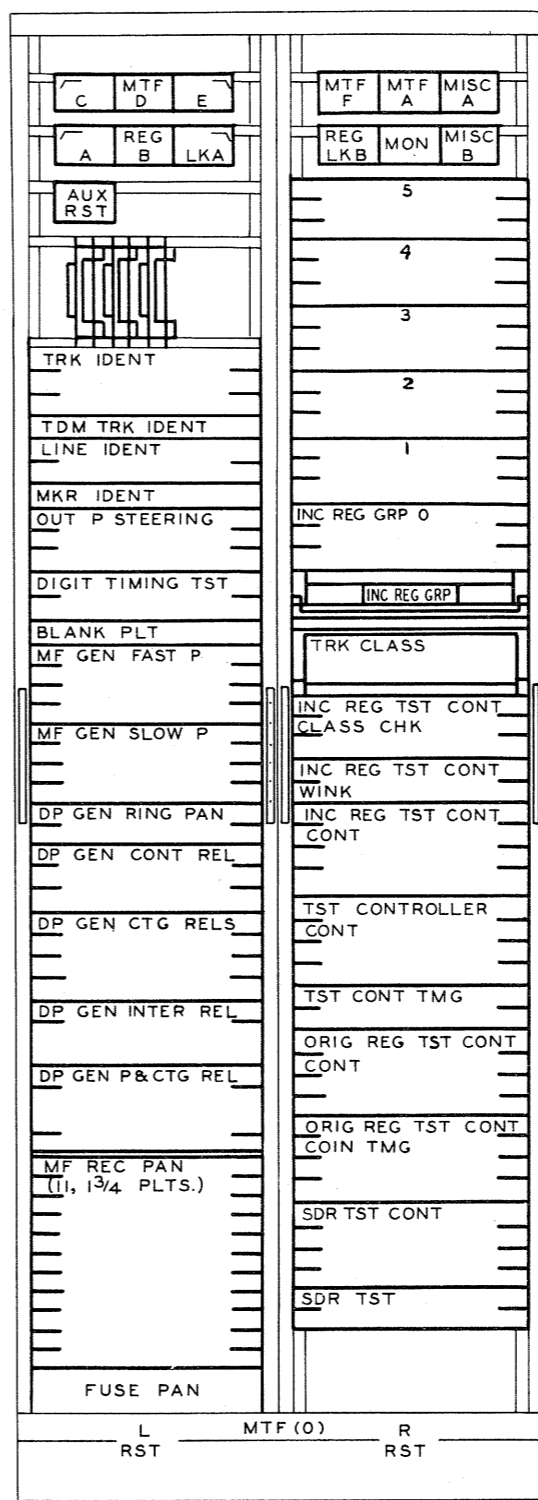
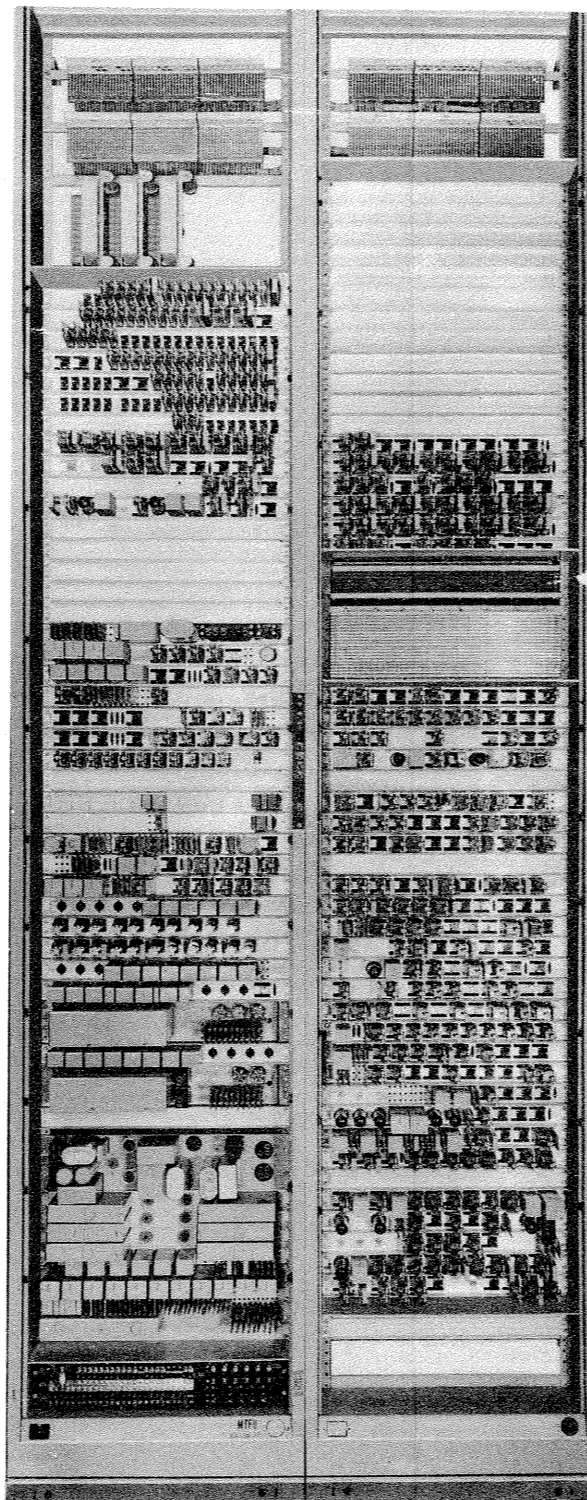

FIG. 58  
 MASTER TEST FRAME  
 RECORDER, CONTROL, AND JACK BAYS



AUTO MON BAY



REG & SDR TEST BAYS

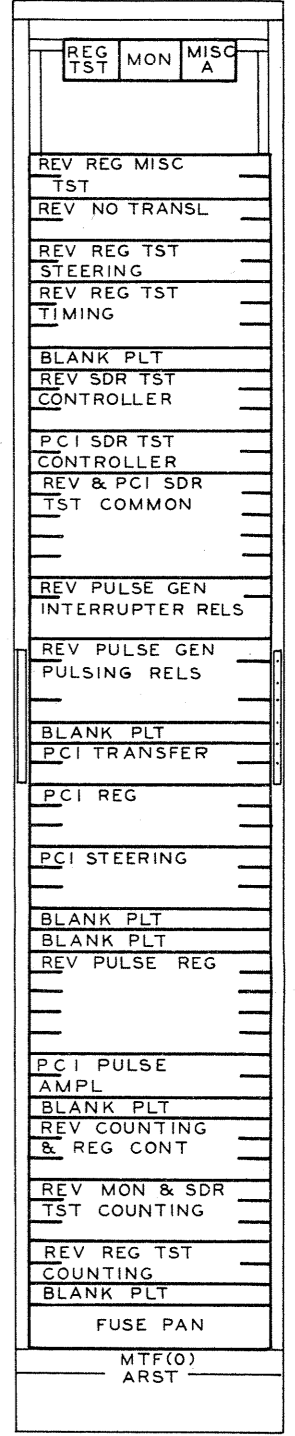
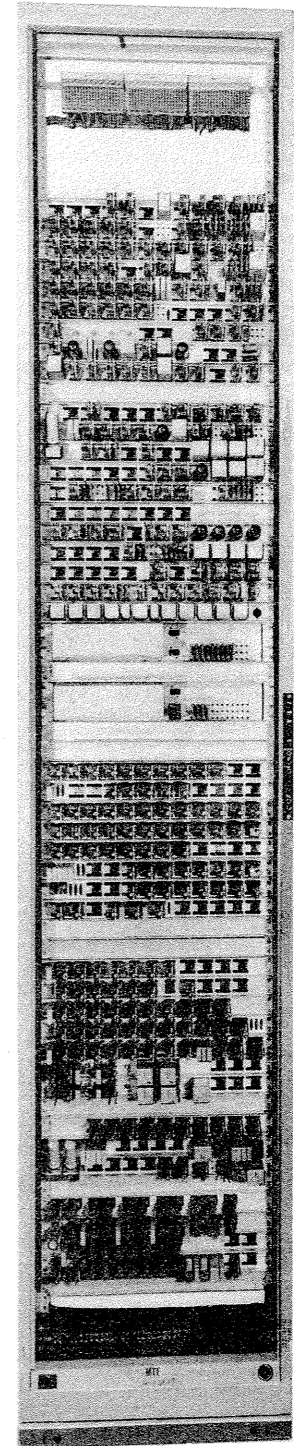

AUX REG & SDR TST BAY

FIG. 59  
MASTER TEST FRAME  
AUTOMATIC MONITOR, REGISTER AND SENDER TEST BAYS

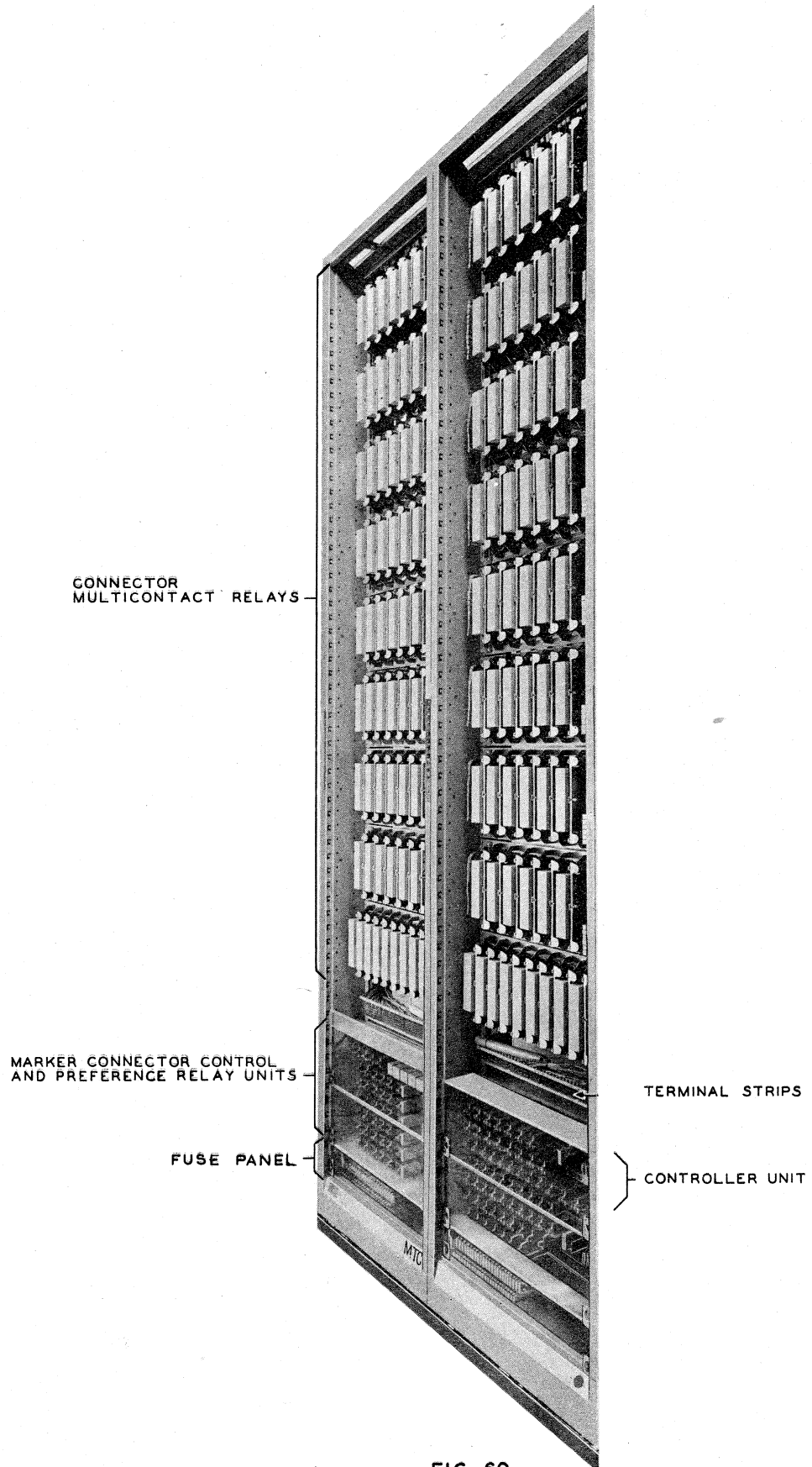

FIG. 60  
MASTER TEST CONNECTOR FRAME



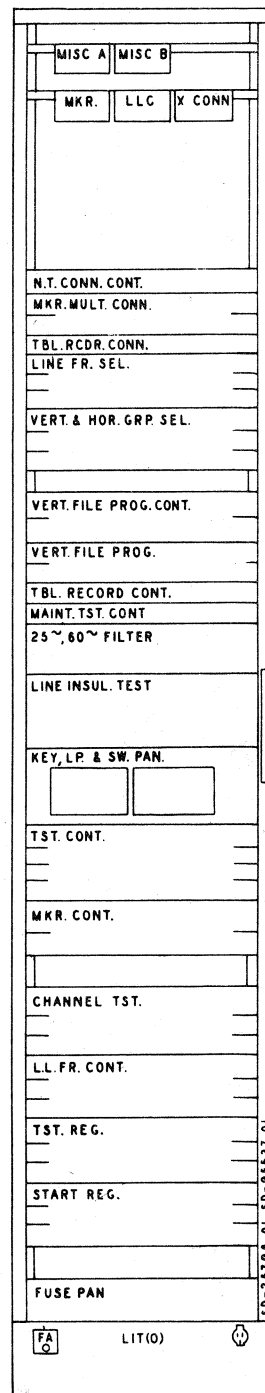
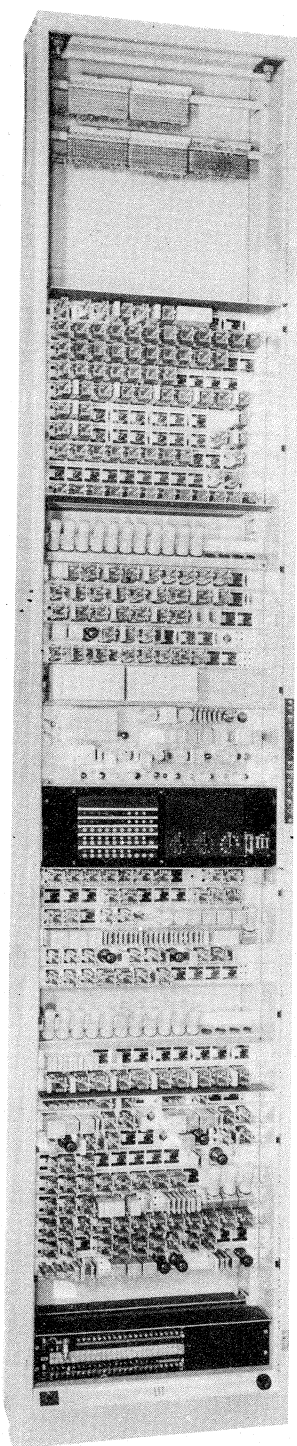

FIG. 62 LINE INSULATION TEST FRAME